

Manual

Interface modules



Model	18801, 18811 18802, 18812 18803, 18813, 18833 18601, 18611 18602, 18612 18613, 18633 18401, 18411 18402, 18412
Release	1.6

© 03/2008 by Wiesemann und Theis GmbH

Subject to error and alteration:

Since it is possible that we make mistakes, you mustn't use any of our statements without verification. Please, inform us of any error or misunderstanding you come about, so we can identify and eliminate it as soon as possible.

Carry out your work on or with W&T products only to the extent that they are described here and after you have completely read and understood the manual or guide. We are not liable for unauthorized repairs or tampering. When in doubt, check first with us or with your dealer.

The modular design of all W&T Com-Servers as well as most of the W&T PC cards allows them to be equipped with various serial interface types.

Modification of the standard units is accomplished by simply exchanging the existing interface modules with modules of the desired interface type.

The W&T interface module family is described on the following pages along with the corresponding technical data and including connection examples.

For up-to-date information on new developments, see our Internet site at <http://www.wut.de> or check the e-mail short notices at the W&T Interface Club, which you can also subscribe to from the W&T Homepage.

Index

Common characteristics and mechanical details 53

RS232 DTE Interface Modules, Model 188x1 55

RS232 DCE Interface Modules, Model 188x2 57

RS232/RS422/RS485 Interface Modules, Model 188x3 59

RS422/RS485 Interface Modules, Model 186x1 67

Profibus Interface Modules, Model 186x2 75

RS422/RS485 Interface Modules with OVP, Model 186x3 79

20mA Interface Modules, Model 184x1 87

20mA Interface Modules, Model 184x2 91

Common characteristics and mechanical details

Many W&T Interfaces are characterized by modular construction with a strict division into basic and interface electronics, so that changing out the integrated, plug-in Interface Modules allows you to freely select the interface type for the device.

In addition you can use the W&T Interface Modules to equip third-party devices which only have a serial TTL interface with various standard interfaces: RS232, RS422, RS485 and 20mA.

There are two different series of W&T Interface Modules (series 18x0x and 18x1x) which differ only in the arrangement of the connector for the serial TTL port, but which are otherwise identical in function.

All W&T Interface Modules have a 12-pin 2mm header and a central hole for screwing the module to the associated motherboard. The pin configuration for the TTL interface can be found in the corresponding sections for the individual Module descriptions.

The position of pin 1 of the header, which is additionally indicated by a square solder pad, as well as the numbering order of the connector pins, can be seen for both Module series in the following diagram:

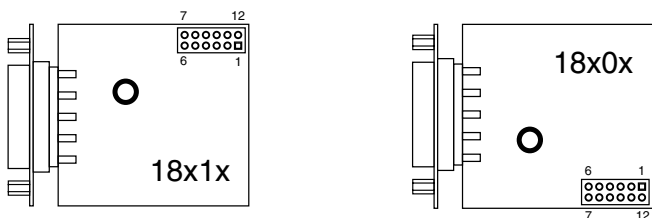

Dimensional drawing

The following drawing indicates the dimensions of the Module as well as the position of the connectors and attachment points. Shown in the drawing is the Combi-Module 18833, but the dimensions apply to all Modules with SUB-D connector.

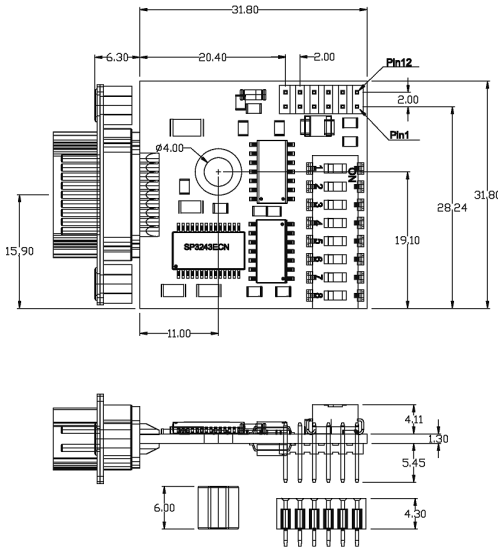

Important installation note

When installing or replacing the Interface Modules, visually inspect to ensure that the module does not cause a short circuit with adjacent components.



RS232 DTE Interface Modules, #188x1**Function**

The W&T Interface Modules 18801 and 18811 provide an RS232 DTE interface for devices equipped with a serial TTL port. The modules support all RS232 data and handshaking signals. Modules 18801 and 18811 differ only in the arrangement of the post connector for the serial TTL port, and are in every other respect functionally identical.

Important installation note

When installing or replacing the Interface Modules, visually inspect to ensure that the module does not cause a short circuit with adjacent components.

**Supply voltage**

The Interface Modules require a regulated supply voltage of 5V DC $\pm 5\%$. The no-load current draw of the modules is approx. 30mA (typ.); any additional current requirement from an external load must of course be taken into account when dimensioning the power supply.

Protection against static discharges

All external signal lines use ESD-immune interface components to provide protection against static discharges of up to 15kV per IEC 801-2, Level 4.

Pin configuration

The RS232 connection for the modules is configured as a 9-pin male SUB-D connector, with the TTL interface formatted as 12-pin male post connector. Refer to the following table for connector pin assignments:

TTL interface

pin#	signal	function
1	5V \pm 5%	Vcc
2	RI	output
3	RxD	output
4	TxD	input
5	n.c.	n.c.
6	CTS	output
7	DTR	input
8	DSR	output
9	RTS	input
10	DCD	output
11	12V \pm 10%	n.c.
12	GND	signal GND

RS232 interface

pin#	signal	function
1	DCD	input
2	RxD	input
3	TxD	output
4	DTR	output
5	GND	GND
6	DSR	input
7	RTS	output
8	CTS	input
9	RI	input

Pin 1 of the TTL interface is indicated by a rectangular soldering pad.

Technical Data

Baud rate:	0..230 Kbaud
Data format:	any
Supported signals:	RxD, TxD, RTS, CTS, DSR, DCD, DTR, RI
ESD immunity:	up to 15kV per IEC 801-2, Level 4 using ESD-immune interface components
Supply voltage:	5V DC \pm 5%
Supply current:	approx. 30mA
TTL connector:	12-pin, 2mm post connector
RS232 connector:	9-pin male SUB-D connector
Dimensions:	43 x 31 mm
Weight:	approx. 10g
Packing list:	RS232 DTE Interface Module

RS232 DCE Interface Modules, #188x2**Function**

The W&T Interface Modules 18802 and 18812 provide an RS232 DCE interface for devices equipped with a serial TTL port. The modules support all RS232 data and handshaking signals. Modules 18802 and 18812 differ only in the arrangement of the post connector for the serial TTL port, and are in every other respect functionally identical.

Important installation note

When installing or replacing the Interface Modules, visually inspect to ensure that the module does not cause a short circuit with adjacent components.

**Supply voltage**

The Interface Modules require a regulated supply voltage of 5V DC $\pm 5\%$. The no-load current draw of the modules is approx. 30mA (typ.); any additional current requirement from an external load must of course be taken into account when dimensioning the power supply.

Protection against static discharges

All external signal lines use ESD-immune interface components to provide protection against static discharges of up to 15kV per IEC 801-2, Level 4.

Pin configuration

The RS232 connection for the modules is configured as a 9-pin female SUB-D connector, with the TTL interface formatted as 12-pin male post connector. Refer to the following table for connector pin assignments:

TTL interface

pin#	signal	function
1	5V \pm 5%	Vcc
2	RI	input
3	TxD	output
4	RxD	input
5	n.c.	n.c.
6	DTR	output
7	CTS	input
8	DSR	input
9	RTS	output
10	DCD	input
11	12V \pm 10%	n.c.
12	GND	signal GND

RS232 interface

pin#	signal	function
1	DCD	output
2	RxD	output
3	TxD	input
4	DTR	input
5	GND	GND
6	DSR	output
7	RTS	input
8	CTS	output
9	RI	output

Pin 1 of the TTL interface is indicated by a rectangular soldering pad.

Technical Data

Baud rate:	0..230 Kbaud
Data format:	any
Supported signals:	RxD, TxD, RTS, CTS, DSR, DCD, DTR, RI
ESD immunity:	up to 15kV per IEC 801-2, Level 4 using ESD-immune interface components
Supply voltage:	5V DC \pm 5%
Supply current:	approx. 30mA
TTL connector:	12-pin, 2mm post connector
RS232 connector:	9-pin female SUB-D connector
Dimensions:	43 x 31 mm
Weight:	approx. 10g
Packing list:	RS232 DCE Interface Module

RS232/RS422/RS485 Interface Modules, #188x3**Function**

The W&T Interface Modules 18803, 18813 and 18833 provide an RS232, RS422 or RS485 interface for devices equipped with a serial TTL port. The Interface Module is configurable for the various operating modes via an 8-position DIL switch. Modules 18803 and 18813/18833 differ only in the arrangement of the post connector for the serial TTL port, and are in every other respect functionally identical.

Important installation note

When installing or replacing the Interface Modules, visually inspect to ensure that the module does not cause a short circuit with adjacent components.

**Supply voltage**

The Interface Modules require a regulated supply voltage of 5V DC $\pm 5\%$ (18803 and 18813) and 3,3V DC $\pm 5\%$ (18833) respectively. The no-load current draw of the modules is approx. 40mA (typ.); any additional current requirement from an external load must of course be taken into account when dimensioning the power supply.

Protection against static discharges

All external signal lines use ESD-immune interface components to provide protection against static discharges of up to 15kV per IEC 801-2, Level 4.

Pin configuration

The RS232/RS422/RS485 connection for the modules is configured as a 9-pin male SUB-D connector, with the TTL interface formatted as 12-pin male post connector. Refer to the following table for connector pin assignments:

TTL interface

pin#	signal	RS232	RS422/485
1	5V \pm 5%	Vcc	Vcc
2	RI	output	"low" level
3	RxD	output	output
4	TxD	input	input
5	n.c.	n.c.	n.c.
6	CTS	output	output
7	DTR	input	input
8	DSR	output	"low" level
9	RTS	input	input
10	DCD	output	"low" level
11	12V \pm 10%	n.c.	n.c.
12	GND	signal GND	signal GND

Pin 1 of the TTL interface is indicated by a rectangular soldering pad.

RS232 interface

pin#	signal	function
1	DCD	input
2	RxD	input
3	TxD	output
4	DTR	output
5	GND	GND
6	DSR	input
7	RTS	output
8	CTS	input
9	RI	input

RS422/RS485 interface

pin#	signal	function
1	TXD A	output
2	RxD A	input
3	DTR A	output
4	CTS A	input
5	GND	GND
6	TXD B	output
7	RxD B	input
8	DTR B	output
9	CTS B	input

Operating modes

The Interface Modules are configurable for the following modes using DIL switches:

RS232

The Interface Module converts all available TTL data and handshake signals into RS232 signals. This mode provides one Rx/D and Tx/D channel each in the respective direction, along with six handshake channels (RTS, CTS, DSR, DCD, DTR and RI).

RS422

The Interface Module supports one data and one handshake channel each (selectable DTR or RTS handshake output). The RS422 sender/receivers are always active.

RS485

One data channel in each direction is always available in all RS485 modes. These modes differ only in how the RS485 transceivers are controlled.

RS485 4-wire bus master

In this mode the master uses a conductor pair to send requests to the slaves, which in turn send their replies to the master on an additional common conductor pair. The RS485 transceivers are always active in this mode, whereby the master can always send and is constantly listening for the slaves.

RS485 4-wire mode with handshake control

The RS485 driver chip is turned on with a TTL Low level on the „DTR“ or „RTS“ line, whereas a TTL High level on this line puts the driver in a high-impedance state. The receiving channel in this mode is always active.

RS485 2-wire mode with handshake control

The RS485 driver chip is turned on with a TTL Low level on the „DTR“ or „RTS“ line, whereas a TTL High level on this line puts the driver in a high-impedance state. The receiving channel is deactivated when the driver is on, and enabled when the driver is in the high-impedance state.

RS485 4-wire mode with automatic control

The RS485 driver chip is automatically activated whenever data are output and brought to the high-impedance state when data output is finished. The receiving channel in this mode is always active.

RS485 2-wire mode with automatic control

The RS485 driver chip is automatically activated when data are output and brought to the high-impedance state when data output is finished. The receiving channel is deactivated when the driver is turned on, and enabled when the driver is in the high-impedance state.

The DIL switch settings can be found in the following table:

Operating mode	SW1	SW2	SW3	SW4	SW5	SW6	SW7	SW8
RS232	OFF	OFF	OFF	OFF	OFF	OFF	OFF	ON
RS422, RS485, 4-wire bus master DTR handshake	OFF	OFF	OFF	ON	OFF	*	*	OFF
RS422, RS485, 4-wire bus master RTS handshake	OFF	OFF	OFF	OFF	ON	*	*	OFF
RS485, 4-wire / 2-wire with echo DTR control	OFF	OFF	ON	ON	OFF	*	*	OFF
RS485, 2-wire without echo DTR control	ON	OFF	ON	ON	OFF	*	*	OFF
RS485, 4-wire / 2-wire with echo RTS control	OFF	OFF	ON	OFF	ON	*	*	OFF
RS485, 2-Draht without echo RTS control	ON	OFF	ON	OFF	ON	*	*	OFF
RS485, 4-wire / 2-wire with echo automatic control	OFF	ON	OFF	ON	OFF	*	*	OFF
RS485, 2-wire without echo automatic control	ON	ON	OFF	ON	OFF	*	*	OFF

*) Terminating the bus system when required.

Important Note

The terminating DIL switches SW6 and SW7 must never be in the ON position when using the module in RS232 mode. This will result in a significant increase in the current draw and may cause the RS232 driver to fail.



Termination

All RS485 modes require termination of the bus system with a termination network. The resistor combination integrated in the module performs two tasks in RS485 applications:

1. The connected line is terminated corresponding to its impedance, which prevents signal reflections at the cable end.
2. In the high-impedance phases of bus operation a defined quiescent state is ensured.

The bus system is allowed to be terminated with the termination network only in RS485 and RS422 modes, but not in RS232 mode.

Closing DIL switches 6 and 7 on the Interface Module connects the bus terminals to the following resistance network:

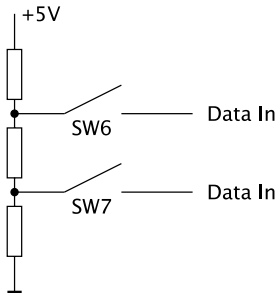

Connection examples

RS232 application with hardware handshake

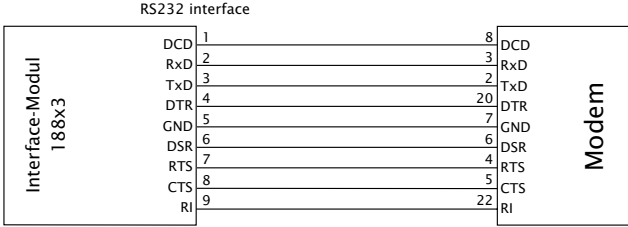

RS422 application with hardware handshake

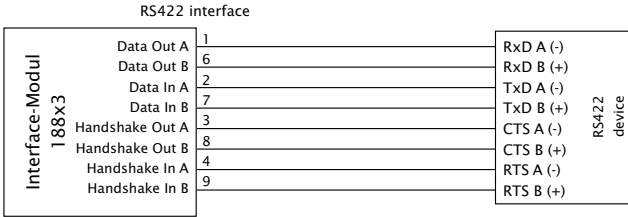

RS485 4-wire bus master application

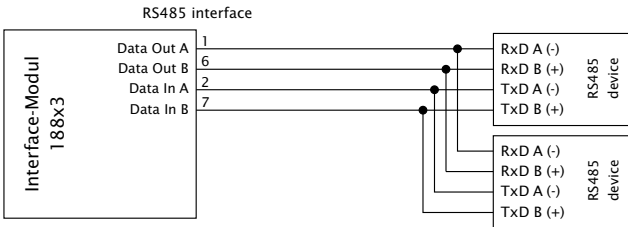

RS485 2-wire application

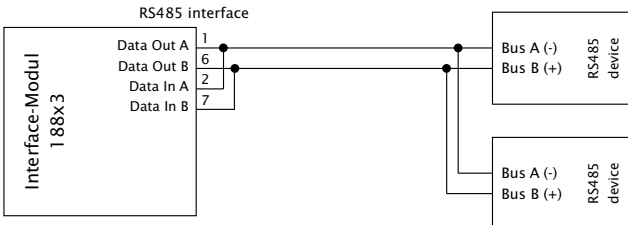

Technical Data

Operating modes:	RS232 RS422 RS485 2/4 wire mode with handshake or automatic control
Switchover delay:	approx. 10µs from send to receive for RS485 automatic control (can be factory changed on request)
Baud rate:	RS232: 0..230 KBaud RS422: 0..10 MBaud RS485: 0..5 MBaud
Data format:	any
Supported signals:	RS232: RxD, TxD, RTS, CTS DSR, DCD, DTR, RI RS422: RxD A/B, TxD A/B CTS A/B, DTR A/B RS485: RXD A/B, TxD A/B
ESD immunity:	up to 15kV per IEC 801-2, Level 4 using ESD-immune interface components
Supply voltage:	18803,18813: 5V DC ±5% 18833: 3,3V DC ±5%
Supply current:	approx. 40mA
TTL connector:	12-pin, 2mm post connector
RS232/422/485 connector:	9-pin male SUB-D connector
Dimensions:	43 x 31 mm
Weight:	approx. 10g
Packing list:	RS232/RS422/RS485 Interface Module

RS422/RS485 Interface Modules, #186x1**Function**

The W&T Interface Modules 18601 and 18611 provide an RS422 or RS485 interface for devices equipped with a serial TTL port. The Interface Module is configurable for the various operating modes via an 8-position DIL switch. Modules 18601 and 18611 differ only in the arrangement of the post connector for the serial TTL port, and are in every other respect functionally identical.

Important installation note

When installing or replacing the Interface Modules, visually inspect to ensure that the module does not cause a short circuit with adjacent components.

**Supply voltage**

The Interface Modules require a regulated supply voltage of 5V DC $\pm 5\%$. The no-load current draw of the modules is approx. 40mA (typ.); any additional current requirement from an external load must of course be taken into account when dimensioning the power supply.

Protection against static discharges

All external signal lines use ESD-immune interface components to provide protection against static discharges of up to 15kV per IEC 801-2, Level 4.

Pin configuration

The RS422/RS2485 connection for the modules is configured as a 9-pin male SUB-D connector, with the TTL interface formatted as 12-pin male post connector. Refer to the following table for connector pin assignments:

TTL interface

pin#	signal	function
1	5V \pm 5%	Vcc
2	RI	"low" level
3	RxD	output
4	TxD	input
5	n.c.	n.c.
6	CTS	output
7	DTR	input
8	DSR	conn. to CTS
9	RTS	input
10	DCD	"low" level
11	12V \pm 10%	n.c.
12	GND	signal GND

RS422/RS485 interface

pin#	signal
1	TXD A
2	RxD A
3	DTR A
4	CTS A
5	GND
6	TXD B
7	RxD B
8	DTR B
9	CTS B

Pin 1 of the TTL interface is indicated by a rectangular soldering pad.

Operating modes

The Interface Modules are configurable for the following modes using DIL switches:

RS422

The Interface Module supports one data and one handshake channel each (selectable DTR or RTS handshake output). The RS422 sender/receivers are always active.

RS485

One data channel in each direction is always available in all RS485 modes. These modes differ only in how the RS485 transceivers are controlled.

RS485 4-wire bus master

In this mode the master uses a conductor pair to send requests to the slaves, which in turn send their replies to the master on an additional common conductor pair. The RS485 transceivers are always active in this mode, whereby the master can always send and is constantly listening for the slaves.

RS485 4-wire mode with handshake control

The RS485 driver chip is turned on with a TTL Low level on the „DTR“ or „RTS“ line, whereas a TTL High level on this line puts the driver in a high-impedance state. The receiving channel in this mode is always active.

RS485 2-wire mode with handshake control

The RS485 driver chip is turned on with a TTL Low level on the „DTR“ or „RTS“ line, whereas a TTL High level on this line puts the driver in a high-impedance state. The receiving channel is deactivated when the driver is on, and enabled when the driver is in the high-impedance state.

RS485 4-wire mode with automatic control

The RS485 driver chip is automatically activated whenever data are output and brought to the high-impedance state when data output is finished. The receiving channel in this mode is always active.

RS485 2-wire mode with automatic control

The RS485 driver chip is automatically activated when data are output and brought to the high-impedance state when data output is finished. The receiving channel is deactivated when the driver is turned on, and enabled when the driver is in the high-impedance state.

The DIL switch settings can be found in the following table:

Operating mode	SW1	SW2	SW3	SW4	SW5	SW6	SW7	SW8
RS422, RS485, 4-wire bus master DTR handshake	OFF	OFF	OFF	ON	OFF	*	*	OFF
RS422, RS485, 4-wire bus master RTS handshake	OFF	OFF	OFF	OFF	ON	*	*	OFF
RS485, 4-wire / 2-wire with echo DTR control	OFF	OFF	ON	ON	OFF	*	*	OFF
RS485, 2-wire without echo DTR control	ON	OFF	ON	ON	OFF	*	*	OFF
RS485, 4-wire / 2-wire with echo RTS control	OFF	OFF	ON	OFF	ON	*	*	OFF
RS485, 2-Draht without echo RTS control	ON	OFF	ON	OFF	ON	*	*	OFF
RS485, 4-wire / 2-wire with echo automatic control	OFF	ON	OFF	ON	OFF	*	*	OFF
RS485, 2-wire without echo automatic control	ON	ON	OFF	ON	OFF	*	*	OFF

*) Terminating the bus system when required.

Termination

All RS485 modes require termination of the bus system with a termination network. The resistor combination integrated in the module performs two tasks in RS485 applications:

1. The connected line is terminated corresponding to its impedance, which prevents signal reflections at the cable end.
2. In the high-impedance phases of bus operation a defined quiescent state is ensured.

Closing DIL switches 6 and 7 on the Interface Module connects the bus terminals to the following resistance network:

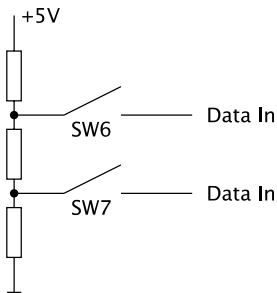

Connection examples

RS422 application with hardware handshake

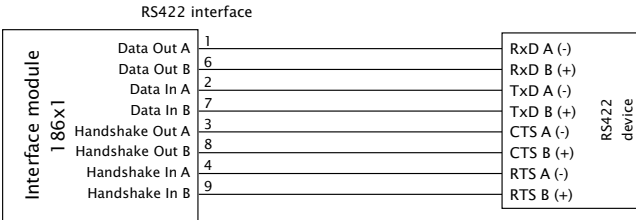

RS485 4-wire bus master application

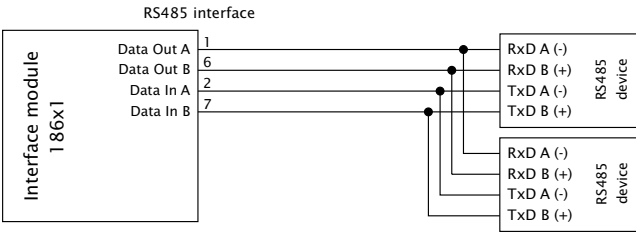

RS485 2-wire application

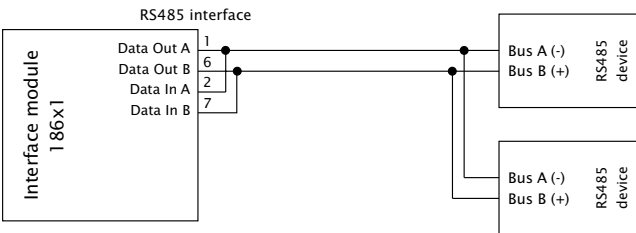

Technical Data

Operating modes:	RS422 RS485 2/4 wire mode with handshake or automatic control
Switchover delay:	approx. 10 μ s from send to receive for RS485 automatic control (can be factory changed on request)
Baud rate:	RS422: 0..10 MBaud RS485: 0..5 MBaud
Data format:	any
Supported signals:	RS422: RXD A/B, TXD A/B CTS A/B, DTR A/B RS485: RXD A/B, TXD A/B
ESD immunity:	up to 15kV per IEC 801-2, Level 4 using ESD-immune interface components
Supply voltage:	5V DC \pm 5%
Supply current:	approx. 40mA
TTL connector:	12-pin, 2mm post connector
RS422/485 connector:	9-pin male SUB-D connector
Dimensions:	43 x 31 mm
Weight:	approx. 10g
Packing list:	RS422/RS485 Interface Module

Profibus Interface Modules, #186x2**Function**

The W&T Interface Modules 18602 and 18612 provide an RS485 2-wire-interface with Profibus pinout for devices equipped with a serial TTL port. Modules 18602 and 18612 differ only in the arrangement of the post connector for the serial TTL port, and are in every other respect functionally identical.

Important installation note

When installing or replacing the Interface Modules, visually inspect to ensure that the module does not cause a short circuit with adjacent components.

**Supply voltage**

The Interface Modules require a regulated supply voltage of 5V DC $\pm 5\%$. The no-load current draw of the modules is approx. 40mA (typ.); any additional current requirement from an external load must of course be taken into account when dimensioning the power supply.

Protection against static discharges

All external signal lines use ESD-immune interface components to provide protection against static discharges of up to 15kV per IEC 801-2, Level 4.

Pin configuration

The Profibus connection for the modules is configured as a 9-pin female SUB-D connector, with the TTL interface formatted as 12-pin male post connector. Refer to the following table for connector pin assignments:

TTL interface

pin#	signal	function
1	5V ±5%	Vcc
2	RI	"low" level
3	RxD	output
4	TxD	input
5	n.c.	n.c.
6	CTS	"low" level
7	DTR	n.c.
8	DSR	"low" level
9	RTS	n.c.
10	DCD	"low" level
11	12V ±10%	n.c.
12	GND	signal GND

Profibus interface

pin#	signal
1	Shield
2	n.c.
3	RxD/TxD-P
4	CNTR-P
5	DGND
6	VP
7	n.c.
8	RxD/TxD-N
9	CNTR-N

Pin 1 of the TTL interface is indicated by a rectangular soldering pad.

Operating modes

The RS485 interface module basically operates in RS485 2-wire mode with automatic control.

One data channel in each direction is available. The RS485 output driver is activated automatically with each transmission of data, and goes to the high impedance state again after the end of transmission. The RS485 receiving channel is deactivated when the driver is on, but is switched on when the driver is in the high impedance state.

Technical Data

Operating mode:	RS485 2-wire mode without echo, automatic control
Switchover delay:	approx. 1 μ s from send to receive for RS485 automatic control (can be factory changed on request)
Baud rate:	0..10 MBaud
Data format:	any
Supported signals:	RxD/TxD-P , RxD/TxD-N
ESD immunity:	up to 15kV per IEC 801-2, Level 4 using ESD-immune interface components
Supply voltage:	5V DC \pm 5%
Supply current:	approx. 40mA
TTL connector:	12-pin, 2mm post connector
Profibus connector:	9-pin female SUB-D connector
Dimensions:	43 x 31 mm
Weight:	approx. 10g
Packing list:	Profibus Interface Module

RS422/RS485 Interface Modules with OVP, #186x3**Function**

The W&T Interface Modules 18613 and 18633 provide an RS422 or RS485 interface for devices equipped with a serial TTL port. The Interface Modules are configurable for the various operating modes via an 8-position DIL switch. Modules 18613 and 18633 differ only in the supply voltage level and are in every other respect functionally identical.

Important installation note

When installing or replacing the Interface Modules, visually inspect to ensure that the module does not cause a short circuit with adjacent components.

**Supply voltage**

The interface module 18613 requires a supply voltage of 5V DC $\pm 5\%$, while the module 18633 requires a supply voltage of 3,3V DC $\pm 5\%$. The no-load current draw of the modules is approx. 40mA (typ.); any additional current requirement from an external load must of course be taken into account when dimensioning the power supply.

Protection against static discharges

All external signal lines use ESD-immune interface components to provide protection against static discharges of up to 15kV per IEC 801-2, Level 4.

Overvoltage protection

The maximum differential voltage allowed to reach the RS485 transceiver chip of the interface modules from the outside is around $\pm 12 \dots 14V$ according to the data sheets. Voltage exceeding this amount will inevitably result in destruction of the line drivers.

The interface modules 18613 and 18633 have an integrated overvoltage protection which uses suppressor diodes to limit the maximum voltage to approx. $\pm 9V$.

This overvoltage protection is limited of course by the capacity of the protection diodes used, which can let through a current of 20A for a short time. This means it may not be a substitute for a lightning surge arrestor for long cables in exposed locations (e.g. in the mountains).

Pin configuration

The RS422/RS2485 connection for the modules is configured as a 9-pin male SUB-D connector, with the TTL interface formatted as 12-pin male post connector. Refer to the following table for connector pin assignments:

TTL interface

pin#	signal	function
1	5V $\pm 5\%$	Vcc
2	RI	"low" level
3	RxD	output
4	TxD	input
5	n.c.	n.c.
6	CTS	output
7	DTR	input
8	DSR	conn. to CTS
9	RTS	input
10	DCD	"low" level
11	12V $\pm 10\%$	n.c.
12	GND	signal GND

RS422/RS485 interface

pin#	signal
1	TXD A
2	RxD A
3	DTR A
4	CTS A
5	GND
6	TXD B
7	RxD B
8	DTR B
9	CTS B

Pin 1 of the TTL interface is indicated by a rectangular soldering pad.

Operating modes

The Interface Modules are configurable for the following modes using DIL switches:

RS422

The Interface Module supports one data and one handshake channel each (selectable DTR or RTS handshake output). The RS422 sender/receivers are always active.

RS485

One data channel in each direction is always available in all RS485 modes. These modes differ only in how the RS485 transceivers are controlled.

RS485 4-wire bus master

In this mode the master uses a conductor pair to send requests to the slaves, which in turn send their replies to the master on an additional common conductor pair. The RS485 transceivers are always active in this mode, whereby the master can always send and is constantly listening for the slaves.

RS485 4-wire mode with handshake control

The RS485 driver chip is turned on with a TTL Low level on the „DTR“ or „RTS“ line, whereas a TTL High level on this line puts the driver in a high-impedance state. The receiving channel in this mode is always active.

RS485 2-wire mode with handshake control

The RS485 driver chip is turned on with a TTL Low level on the „DTR“ or „RTS“ line, whereas a TTL High level on this line puts the driver in a high-impedance state. The receiving channel is deactivated when the driver is on, and enabled when the driver is in the high-impedance state.

RS485 4-wire mode with automatic control

The RS485 driver chip is automatically activated whenever data are output and brought to the high-impedance state when data output is finished. The receiving channel in this mode is always active.

RS485 2-wire mode with automatic control

The RS485 driver chip is automatically activated when data are output and brought to the high-impedance state when data output is finished. The receiving channel is deactivated when the driver is turned on, and enabled when the driver is in the high-impedance state.

The DIL switch settings can be found in the following table:

Operating mode	SW1	SW2	SW3	SW4	SW5	SW6	SW7	SW8
RS422, RS485, 4-wire bus master DTR handshake	OFF	OFF	OFF	ON	OFF	*	*	**
RS422, RS485, 4-wire bus master RTS handshake	OFF	OFF	OFF	OFF	ON	*	*	**
RS485, 4-wire / 2-wire with echo DTR control	OFF	OFF	ON	ON	OFF	*	*	**
RS485, 2-wire without echo DTR control	ON	OFF	ON	ON	OFF	*	*	**
RS485, 4-wire / 2-wire with echo RTS control	OFF	OFF	ON	OFF	ON	*	*	**
RS485, 2-Draht without echo RTS control	ON	OFF	ON	OFF	ON	*	*	**
RS485, 4-wire / 2-wire with echo automatic control	OFF	ON	OFF	ON	OFF	*	*	**
RS485, 2-wire without echo automatic control	ON	ON	OFF	ON	OFF	*	*	**

*) *Terminating the bus system when required.*

**) *Setting the switching time, „ON“ = 10µs, „OFF“ = 50µs*

Setting the switching time

In both RS485 modes of the interface modules the respective RS485 transmitter is automatically placed in the active state as soon as data transmission begins, and turned off again with a time delay at the end of the data telegram.

Switch S8 on the DIL switch bank of the interface modules can be used to set the switching time for the respective interface between send and receive mode to values of 10 μ s (S8 = „on“) and 50 μ s (S8 = „off“).

The required value for the switching time depends on a number of factors, among which are the baud rate, the response time of the accessed RS485 slaves, and the overall length of the bus system. For this reason it is not feasible to provide an ideal value for all conceivable applications.

In practical terms you should use a value for the switching time which lies in the range of a bit time. At 115.200 kBaud this would correspond to a time of approx. 10 μ s, and at slower baud rates you should choose the longer of the two times.

Other values are possible by means of a factory component change – please contact us if this is something you need.

Termination

All RS485 modes require termination of the bus system with a termination network. The resistor combination integrated in the module performs two tasks in RS485 applications:

1. The connected line is terminated corresponding to its impedance, which prevents signal reflections at the cable end.
2. In the high-impedance phases of bus operation a defined quiescent state is ensured.

Closing DIL switches 6 and 7 on the Interface Module connects the bus terminals to the following resistance network:

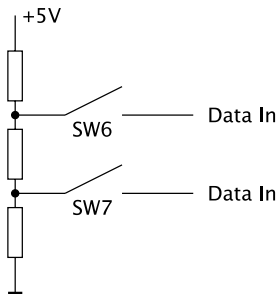

Connection examples

RS422 application with hardware handshake

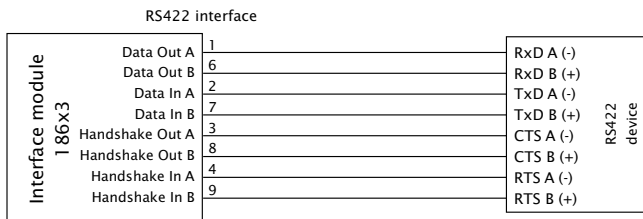

RS485 4-wire bus master application

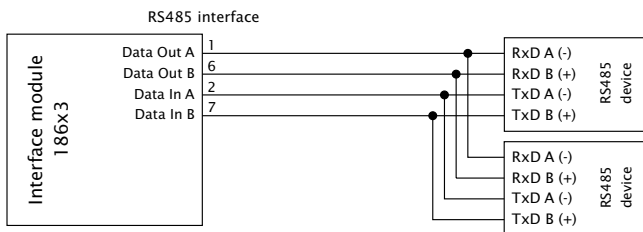

RS485 2-wire application

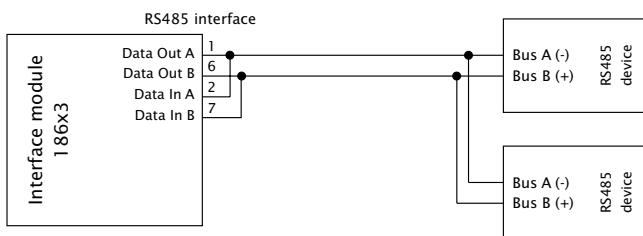

Technical Data

Operating modes:	RS422 RS485 2/4 wire mode with handshake or automatic control
Switchover delay:	selectable 10 μ s / 50 μ s from send to receive for RS485 automatic control (can be factory changed on request)
Baud rate:	RS422: 0..10 MBaud RS485: 0..5 MBaud
Data format:	any
Supported signals:	RS422: RxD A/B, TxD A/B CTS A/B, DTR A/B RS485: RXD A/B, TxD A/B
Overvoltage protection:	limiting of differential voltage by suppressor diodes to $V_{max} = 9,2V$ ($I_{max} = 20A$, $t = 10ms$)
ESD immunity:	up to 15kV per IEC 801-2, Level 4
Supply voltage:	18613: 5V DC $\pm 5\%$ 18633: 3,3V DC $\pm 5\%$
Supply current:	approx. 40mA
TTL connector:	12-pin, 2mm post connector
RS422/485 connector:	9-pin male SUB-D connector
Dimensions:	43 x 31 mm
Weight:	approx. 10g
Packing list:	RS422/RS485 Interface Module with Over Voltage Protection

20mA Interface Modules, #184x1**Function**

The W&T Interface Modules 18401 and 18411 provide a 20mA interface for devices equipped with a serial TTL port. The modules support one data line in each direction and can be used as an active or passive 20mA component.

In the active mode the module supplies the current required by the respective 20mA loop, while in the passive mode the loop current must be supplied by the connected device.

Modules 18401 and 18411 differ only in the arrangement of the post connector for the serial TTL port, and are in every other respect functionally identical.

Important installation note

When installing or replacing the Interface Modules, visually inspect to ensure that the module does not cause a short circuit with adjacent components.

**Supply voltage**

The Interface Modules require a regulated supply voltage of 5V DC $\pm 5\%$. The current draw of the modules is approx. 10mA (typ.). In active mode the modules require an additional unregulated supply voltage of 12V DC.

Protection against static discharges

All external signal lines use ESD-immune interface components to provide protection against static discharges of up to 15kV per IEC 801-2, Level 4.

Pin configuration

The 20mA connection for the modules is configured as a 9-pin male SUB-D connector, with the TTL interface formatted as 12-pin male post connector. Refer to the following table for connector pin assignments:

TTL interface

pin#	signal	function
1	5V \pm 5%	Vcc
2	RI	"low" level
3	RxD	output
4	TxD	input
5	n.c.	n.c.
6	CTS	"low" level
7	DTR	n.c.
8	DSR	"low" level
9	RTS	n.c.
10	DCD	"low" level
11	12V \pm 10%	Vdd (20mA)
12	GND	signal GND

20mA interface

pin#	signal
1	Data Out 20mA
2	Data Out +
3	Data Out -
4	Data Out GND
5	Half Duplex Control
6	Data In 20mA
7	Data In +
8	Data In -
9	Data In GND

Pin 1 of the TTL interface is indicated by a rectangular soldering pad.

Operating modes

A GND level signal on Pin 5 of the SUB-D connector will place the module in half-duplex mode whereby an echo of the sent signals is suppressed. The Interface Module can be used as an active or passive 20mA component. The operating mode can be selected for both loops separately.

Connection examples

Examples of module switching into active/ passive mode are shown on the following drawings:

Active Tx and active Rx current loop application

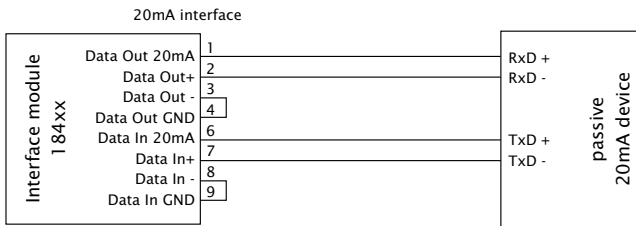

Passive Tx and passive Rx current loop application

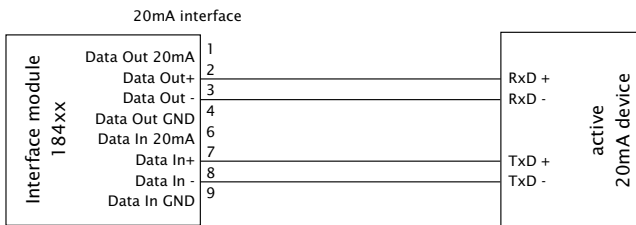

Active Tx and passive Rx current loop application

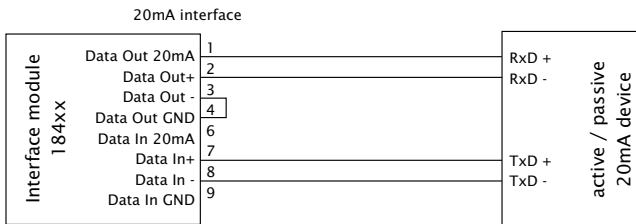

Technical Data

Operating mode:	Active and passive mode Full and halfduplex mode
Baud rate:	0..19.200 Baud
Data format:	any
Supported signals:	RxD, TxD
ESD immunity:	up to 15kV per IEC 801-2, Level 4 using varistors
Supply voltage:	5V DC \pm 5% 12V DC (in active mode only)
Supply current:	approx. 10mA @ 5V approx. 50mA @ 12V
TTL connector:	12-pin, 2mm post connector
20mA connector:	9-pin male SUB-D connector
Dimensions:	43 x 31 mm
Weight:	approx. 10g
Packing list:	20mA Interface Module

20mA Interface Modules, #184x2**Function**

The W&T Interface Modules 18402 and 18412 provide a 20mA interface for devices equipped with a serial TTL port. The modules support one data line in each direction and can be used as an active or passive 20mA component.

In the active mode the module supplies the current required by the respective 20mA loop, while in the passive mode the loop current must be supplied by the connected device.

Modules 18402 and 18412 differ only in the arrangement of the post connector for the serial TTL port, and are in every other respect functionally identical.

Important installation note

When installing or replacing the Interface Modules, visually inspect to ensure that the module does not cause a short circuit with adjacent components.

**Supply voltage**

The Interface Modules require a supply voltage between 3,3 and 5V DC. The current draw of the modules is approx. 30mA @5V (20mA @3,3V) in passive mode and 140mA @5V (210mA @3,3V) in active mode for both current loops.

Protection against static discharges

All external signal lines use ESD-immune interface components to provide protection against static discharges of up to 15kV per IEC 801-2, Level 4.

Pin configuration

The 20mA connection for the modules is configured as a 9-pin male SUB-D connector, with the TTL interface formatted as 12-pin male post connector. Refer to the following table for connector pin assignments:

TTL interface

pin#	signal	function
1	5V \pm 5%	Vcc
2	RI	"low" level
3	RxD	output
4	TxD	input
5	n.c.	n.c.
6	CTS	"low" level
7	DTR	n.c.
8	DSR	"low" level
9	RTS	n.c.
10	DCD	"low" level
11	12V \pm 10%	n.c.
12	GND	signal GND

20mA interface

pin#	signal
1	Data Out 20mA
2	Data Out +
3	Data Out -
4	Data Out GND
5	Half Duplex Control
6	Data In 20mA
7	Data In +
8	Data In -
9	Data In GND

Pin 1 of the TTL interface is indicated by a rectangular soldering pad.

Operating modes

A GND level signal on Pin 5 of the SUB-D connector will place the module in half-duplex mode whereby an echo of the sent signals is suppressed. The Interface Module can be used as an active or passive 20mA component. The operating mode can be selected for both loops separately.

Connection examples

Examples of module switching into active/ passive mode are shown on the following drawings:

Active Tx and active Rx current loop application

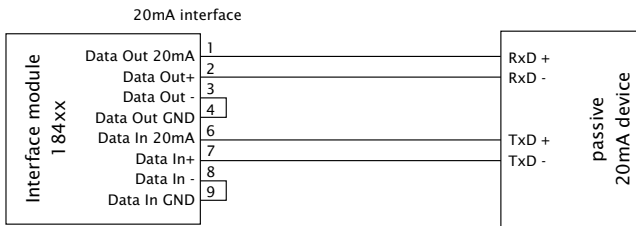

Passive Tx and passive Rx current loop application

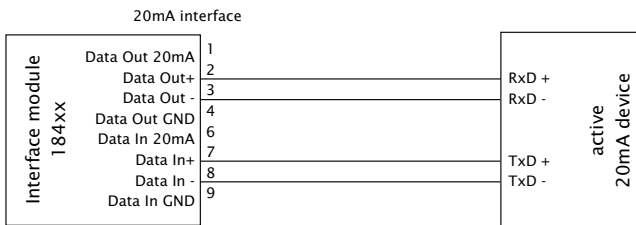

Active Tx and passive Rx current loop application

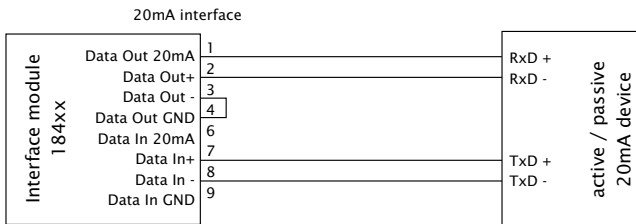

Technical Data

Operating mode:	Active and passive mode Full and halfduplex mode
Baud rate:	0..19.200 Baud
Data format:	any
Supported signals:	RxD, TxD
ESD immunity:	up to 15kV per IEC 801-2, Level 4 using varistors
Supply voltage:	3,3V..5V DC
Min. supply current:	in passive mode: approx. 30mA @5V (20mA @3.3V)
Max. supply current:	both loops in active mode: approx. 140mA @5V (210mA @3,3V)
TTL connector:	12-pin, 2mm post connector
20mA connector:	9-pin male SUB-D connector
Dimensions:	43 x 31 mm
Weight:	approx. 10g
Packing list:	20mA Interface Module

