

Manual

USB-Interfaces



Release
Model

1.2
34201, 36201
38201, 38001
18311

© 06/2007 by Wiesemann & Theis GmbH

Subject to errors and changes:

Since we can make mistakes, none of our statements should be used without checking. Please let us know of any mistakes or misunderstandings you are aware of, so that we can recognize and eliminate them quickly.

Perform work on and with W&T products only as described here and only if you have read and understood the manual fully. Unauthorized use can result in hazards. We are not liable for the consequences of unauthorized use. When in doubt, check with us or consult you dealer!

The Wiesemann & Theis USB industrial interfaces („Industry“ series) represents an entire family of interface converters which are suitable for hat-rail mounting and can be powered by the industry-standard 24V.

The integrated galvanic isolation between the two opposing interfaces as well as between the supply voltage and interfaces ensure trouble-free and noise-immune operation of the connected components.

The W&T USB Interfaces are described on the following pages along with their technical specifications and wiring examples.

For up-to-date information on new developments on the Internet, go to <http://www.wut.de> or the e-mail short infos available from the W&T Interface Club, which you can sign up for at the W&T Homepage.

Contents

Installation and Driver Software 33

USB <> 20mA Interface, #34201 35

USB <> RS422/RS485 Interface, #36201 39

USB <> RS232 Interface, #38201 45

USB <> RS232 Interface Cable , #38001 49

USB interface module, #18311 53

Installation and Driver Software

Startup of USB devices has become a trouble-free procedure thanks to automatic detection of newly connected hardware offered in modern operating systems and by the mostly automated process of driver installation.

Installing the hardware

The Interface is connected to the free USB port on a computer, a USB hub or a USB device having hub functions using the included USB cable. In addition, the Industry Interfaces must be powered using the power supply provided or by an external voltate source, since the USB cannot itself provide the voltage of 12...24V required to operate the interface.

The hot-plugging capability of USB makes it possible to connect the Interface to the bus or unplug it again at any time.

Housing

The W&T USB Industry Interfaces are contained in a plastic housing for mounting on standard rails according to EN 50022-35.

To configure the RS485 / RS422 Interfaces, the enclosure must be opened to set the mode type/termination DIL switches on the interface module.

For this purpose we recommend threading a SUB-D connector with connector body onto the Interface and use the threaded-on connector to assist in removing the housing cover from the housing body.



Driver software

With the exception of Linux, the serial USB interfaces can be accessed under the various operating systems only by using special drivers. These drivers are in a constant state of development with respect to their technical features as well as the number and type of compatible operating systems.

For this reason, W&T makes the current drivers and software installation guides available on the datasheet pages of our Web site at <http://www.wut.de>.

Whereas Linux kernel version 2.4 and higher supports the Interfaces directly without any additional drivers, on Windows 98, Windows 2000 and Windows XP the driver installs virtual COM Ports through which the serial ports of the Interfaces can be accessed.

Detailed information about installation and configuration of the drivers under the various operating systems is found on the enclosed diskette.

USB <> 20mA Interface, #34201

The 34201 Interface permits galvanically isolated, bi-directional connection of active and passive 20mA devices with computers having an USB port.

Function

This Interface supports one data line in each direction and uses galvanic isolation between the USB and the 20mA side in all operating modes. The converter is contained in a plastic housing for mounting on standardized rails according to EN 50022-35.

Power supply

The supply voltage for the Interface is provided by means of an integrated switching regulator. This regulator has a variable input voltage range and allows the Interface to be supplied either by the AC adaptor provided or by any DC or AC voltage between 12 and 24 volts. The supply voltage line is polarity reverse protected and is connected using the plug-in screw terminal provided.

It is unfortunately not possible to supply the Interface from the USB, since a voltage of at least 12 V is required.

Galvanic isolation and ESD protection

Both ports on the Interface are galvanically isolated to 1kV both from each other and from the supply voltage. Galvanic isolation of the signals is accomplished using fast opto-couplers; the driver and receiver chips on the USB and 20mA side are supplied with power by a galvanically isolated DC/DC converter.

All 20mA signal lines are protected against static discharge up to a voltage of 15 kV according to IEC 801-2, Level 4.

Wiring configuration

The 20mA termination of the Interface is implemented as a DB9 plug. The pin assignments for the connector can be found in the following table as well as on a sticker applied to the unit.

20mA port:

Pin#	Function
1	data out 20mA
2	data out +
3	data out -
4	data out GND
5	n.c.
6	data in 20mA
7	data in +
8	data in -
9	data in GND

Display elements

The Interface has two LEDs, green for the correct supply voltage and red for indicating data communication in both directions.

Modes and wiring examples

The Interface can be used both as an active and a passive 20mA component. In active mode the Interface provides the loop current for the respective 20mA loop, whereas in passive mode the connected device must provide the loop current.

The mode can be selected separately over the external configuration of the Interface. Examples for configuring the Interface in active and passive mode can be found in the following application examples:

Interface Tx and Rx loop active

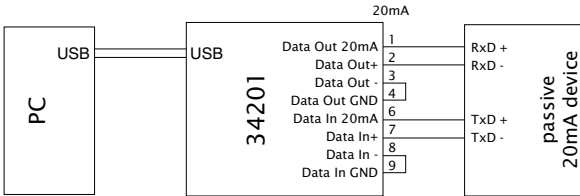

Interface Tx and Rx loop passive

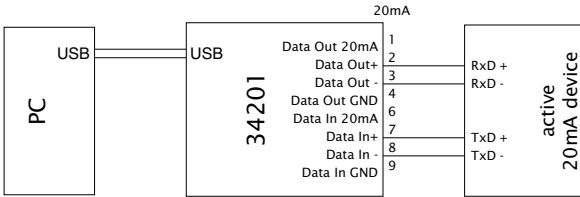

Interface Tx loop active, interface Rx loop passive

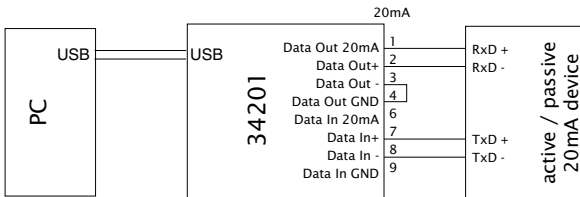

Technical Data

Baud rate:	300..19.200 baud
Data bits:	7 or 8
Stop bits:	1 or 2
Parity:	no, even, odd, mark, space
Supported signals:	RxD, TxD
Modes:	Active Passive
Galvanic isolation:	min. 1kV isolation voltage between the power supply and Interfaces
ESD rating:	up to 15kV per IEC 801-2, Level 4
Supply voltage:	Plug-in power supply or 12..24V AC/DC
Operating current draw:	approx. 175mA @12V DC
USB connector:	USB type B socket
20mA connector:	9-pin SUB-D plug
Ambient temperature:	Storage: -40..+70°C Operating: 0..+60°C with external 24V supply
Housing / Dimensions:	Plastic housing for rail mount according to EN 50022-35, 105 x 75 x 22mm
Weight:	600g incl. power supply
Included:	USB <> 20mA Interface USB cable A-B with ferrite core, AC adaptor for office applications

USB <> RS422/RS485 Interface, #36201

The 36201 Interface allows galvanically isolated, bi-directional connection of RS422 and RS485 devices to computers having an USB port.

Function

The Interface supports one data and one handshake line each in both directions and provides galvanic isolation between the USB and the RS422/RS485 side. The converter is contained in a plastic housing for mounting to standardized rails according to EN 50022-35.

Power supply

The supply voltage for the Interface is provided by means of an integrated switching regulator. This regulator has a variable input voltage range and allows the Interface to be supplied either by the AC adaptor provided or by any DC or AC voltage between 12 and 24 volts. The supply voltage line is polarity reverse protected and is connected using the plug-in screw terminal provided.

It is unfortunately not possible to supply the Interface from the USB, since a voltage of at least 12 V is required.

Galvanic isolation and ESD protection

Both ports on the Interface are galvanically isolated to 1kV both from each other and from the supply voltage. Galvanic isolation of the signals is accomplished using fast opto-couplers; the driver and receiver chips on the USB and RS422/RS485 side are supplied with power by a galvanically isolated DC/DC converter.

All RS422/RS485 signal lines are protected against static discharge up to a voltage of 15kV according to IEC 801-2, Level 4.

Wiring configuration

The RS422/RS485 termination of the Interface is implemented as a DB9 plug. The pin assignments for the connector can be found in the following table as well as on a sticker applied to the unit.

RS422/RS485 port:

Pin#	Function
1	data out A (-)
2	data in A (-)
3	handshake out A (-)
4	handshake in A (-)
5	signal GND
6	data out B (+)
7	data in B (+)
8	handshake out B (+)
9	handshake in B (+)

Display elements

The Interface has two LEDs, green for the correct supply voltage and red for indicating data communication in both directions.

Modes

The RS422/RS485 port of the Interface uses DIL switches to set one of five operating modes, which are described in brief below:

RS422, RS485 4-wire bus master

One data and one handshake channel in each direction. The RS422/RS485 drivers and receivers are always active in this mode.

RS485 4-wire/ 2-wire with echo, handshake control

One data channel in each direction. The RS485 driver chip is switched on when DTR = „ON“, whereas DTR = „OFF“ places the driver in high-impedance state. The receive channel is always active in this mode.

RS485 2-wire without echo, handshake control

One data channel in each direction. The RS485 driver chip is switched on when DTR = „ON“, whereas DTR = „OFF“ places the driver in high-impedance state. The receive channel is deactivated when the driver is turned on, and activated when the driver is in the high-impedance state.

RS485 4-wire/ 2-wire with echo, automatic control

One data channel in each direction. The RS485 driver chip is automatically activated whenever data is sent out and placed in the high-impedance state when data transmission is completed. The receive channel is always active in this mode.

RS485 2-wire without echo, automatic control

One data channel in each direction. The RS485 driver chip is automatically activated whenever data is sent out and placed in the high-impedance state when data transmission is completed. The receive channel is deactivated with the driver is turned on, and activated when the driver is in the high-impedance state.

Setting the modes

For the meaning of the DIL switch settings, see the following table:

Operating mode	SW1	SW2	SW3	SW4	SW5	SW8
RS422, RS485, 4-wire bus master	OFF	OFF	OFF	ON	OFF	OFF
RS485, 4-wire / 2-wire with echo, handshake control	OFF	OFF	ON	ON	OFF	OFF
RS485, 4-wire / 2-wire without echo, handshake control	ON	OFF	ON	ON	OFF	OFF
RS485, 4-wire / 2-wire with echo, automatic control	OFF	ON	OFF	ON	OFF	OFF
RS485, 4-wire / 2-wire without echo, automatic control	ON	ON	OFF	ON	OFF	OFF

Terminating

All RS485 modes require that the bus system be terminated with a terminating network, which ensures a defined idle state.

The bus system can be connected to a terminating network in the Interface by closing DIL switches 6 and 7 on the RS422/RS485 module:

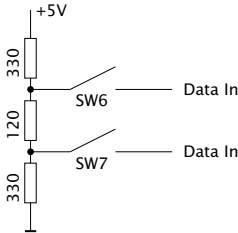

Wiring examples

RS422 hardware handshake application

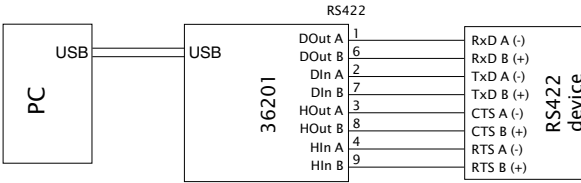

RS485 4-wire bus master application

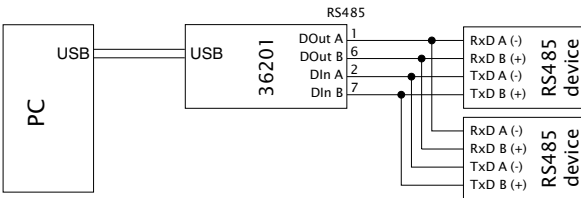

RS485 2-wire application

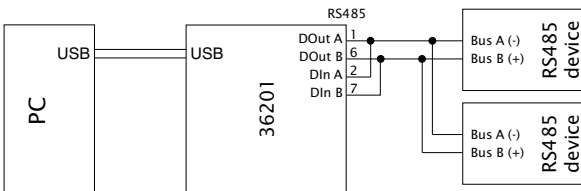

Technical Data

Standard baud rates:	300..115.200 baud
Settable baud rates:	Depending on the application and operating system, up to 3 MBaud Baud rate: $3 \text{ MHz}/n$, $n = 1..16383$
Data bits:	7 or 8
Stop bits:	1 or 2
Parity:	no, even, odd, mark, space
Supported signals:	RxD, TxD, CTS, DTR
Operating modes:	RS422 RS485 2/4 wire mode with automatic control RS485 2/4 wire mode with handshake control
Switchover delay:	approx. $10\mu\text{s}$ from send to receive for RS485 automatic control (can be factory changed on request)
Termination:	Switchable termination network for RS485 mode
Galvanic isolation:	min. 1KV isolation voltage between the interfaces and between the power supply and interfaces
ESD rating:	up to 15kV per IEC 801-2, Level 4
Supply voltage:	AC adapter included or 12..24V AC/DC
Operating current draw:	approx. 150mA @12V DC
USB connector:	USB type B socket
RS422/RS485 connector:	9-pin SUB-D plug
Ambient temperature:	Storage: $-40..+70^{\circ}\text{C}$ Operating: $0..+60^{\circ}\text{C}$ with external 24V supply
Housing / Dimensions:	Plastic housing for rail mounting according to EN 50022-35, 105 x 75 x 22mm
Weight:	approx. 600g incl. power supply
Included:	USB <> RS422/RS485 Interface USB cable A-B with ferrite core, AC adaptor for office applications

USB <> RS232 Interface , #38201

The 38201 Interface allows galvanically isolated, bi-directional connection of RS232 devices to computers having an USB port.

Function

The Interface supports all signals present on the 9-pin RS232 port and has galvanic isolation between the USB and RS232 side. The converter is contained in a plastic housing for mounting to standardized rails according to EN 50022-35.

Power supply

The supply voltage for the Interface is provided by means of an integrated switching regulator. This regulator has a variable input voltage range and allows the Interface to be supplied either by the AC adaptor provided or by any DC or AC voltage between 12 and 24 volts. The supply voltage line is polarity reverse protected and is connected using the plug-in screw terminal provided.

It is unfortunately not possible to supply the Interface from the USB, since a voltage of at least 12 V is required.

Galvanic isolation and ESD protection

Both ports on the Interface are galvanically isolated to 1kV both from each other and from the supply voltage. Galvanic isolation of the signals is accomplished using fast opto-couplers; the driver and receiver chips on the USB and RS232 side are supplied with power by a galvanically isolated DC/DC converter.

All RS232 signal lines are protected against static discharge up to a voltage of 15kV according to IEC 801-2, Level 4.

Wiring configuration

The RS232 termination of the Interface is implemented as a DB9 plug. The pin assignments for the connector can be found in the following table as well as on a sticker applied to the unit.

RS232 port:

Pin#	Function	Direction
1	DCD	input
2	RxD	input
3	TxD	output
4	DTR	output
5	GND	GND
6	DSR	input
7	RTS	output
8	CTS	input
9	RI	input

Display elements

The Interface has two LEDs, green for the correct supply voltage and red for indicating data communication in both directions.

Wiring examples

RS232 wiring example with hardware handshake

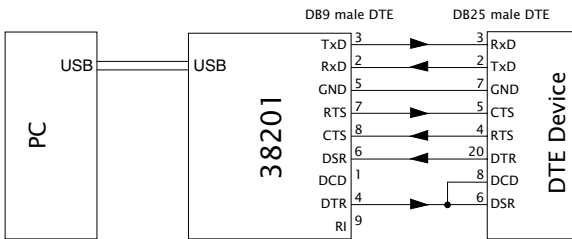
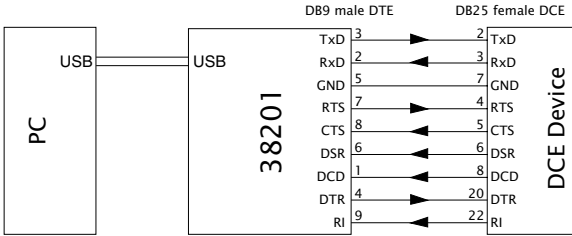

RS232 wiring example with software handshake

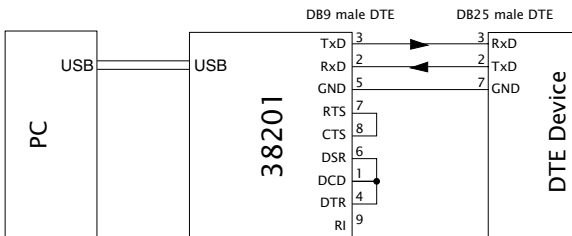
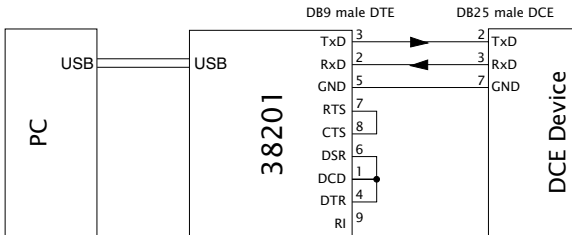

Technical Data

Baud rate:	300..115.200 baud
Data bits:	7 or 8
Stop bits:	1 or 2
Parity:	no, even, odd, mark, space
Supported signals:	RxD, TxD, RTS, CTS, DSR, DCD, DTR, RI
Galvanic isolation:	min. 1kV isolation voltage between the power supply and Interfaces
ESD rating:	up to 15kV per IEC 801-2, Level 4
Supply voltage:	Plug-in power supply or 12..24V AC/DC
Operating current draw:	approx. 150mA @12V DC
USB connector:	USB type B socket
RS232 connector:	9-pin SUB-D plug with DTE pinout
Ambient temperature:	Storage: -40..+70°C Operating: 0..+60°C with external 24V supply
Housing / Dimensions:	Plastic housing for rail mount according to EN 50022-35, 105 x 75 x 22mm
Weight:	600g incl. power supply
Included:	USB <> RS232 Interface USB cable A-B with ferrite core, AC adaptor for office applications

USB <> RS232 Interface Cable, #38001

The 38001 Interface Cable allows bi-directional connection of RS232 devices to computers having an USB port.

Function

The Interface supports all signals present on the 9-pin RS232 port. The converter is contained in a 9-pin SUB-D plastic housing.

Power supply

The interface cable does not require an additional external power supply, but rather receives its power through the USB. The current consumption is approx. 60mA.

ESD protection

All RS232 signal lines are protected against static discharge up to a voltage of 15kV according to IEC 801-2, Level 4.

Wiring configuration

The USB connection is implemented as a USB Type A male connector with 2m of cable, and the RS232 connection as a DB9 DTE male connector. The pin assignments for the connector can be found in the following table:

RS232 port:

Pin#	Function	Direction
1	DCD	input
2	RxD	input
3	TxD	output
4	DTR	output
5	GND	GND
6	DSR	input
7	RTS	output
8	CTS	input
9	RI	input

Wiring examples

RS232 wiring example with hardware handshake

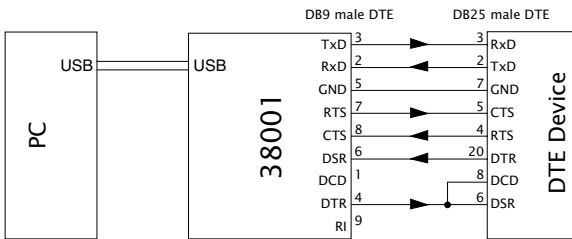
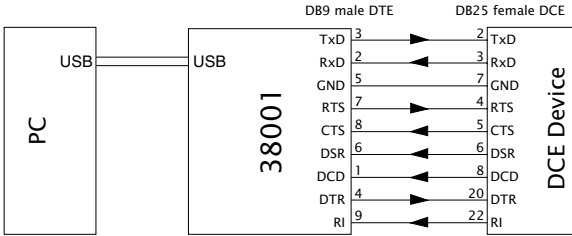

RS232 wiring example with software handshake

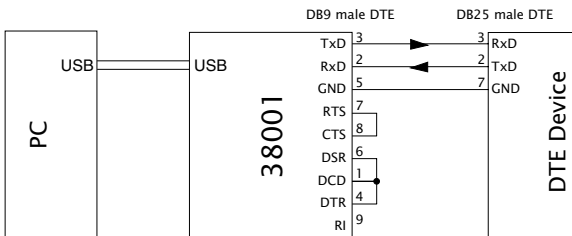
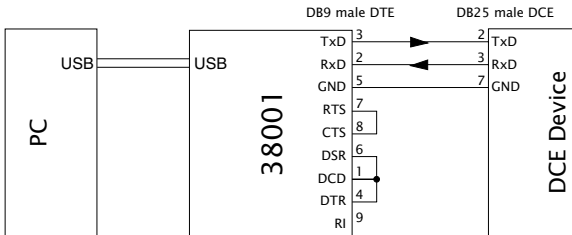

Technical Data

Standard baud rates:	300..115.200 baud
Settable baud rates:	Depending on the application and operating system, up to 1 MBaud Baud rate: $3 \text{ MHz}/n$, $n = 3..16383$
Data bits:	7 or 8
Stop bits:	1 or 2
Parity:	no, even, odd, mark, space
Supported signals:	RxD, TxD, RTS, CTS, DSR, DCD, DTR, RI
Galvanic isolation:	none
ESD rating:	up to 15kV per IEC 801-2, Level 4
Supply voltage:	5V DC via USB
Operating current draw:	approx. 60mA
USB connector:	2m cable with USB type A plug
RS232 connector:	9-pin SUB-D plug with DTE pinout
Ambient temperature:	Storage: -40..+70°C Operating: 0..+60°C
Housing / Dimensions:	9-pin plastic SUB-D housing 50 x 33 x 15 mm
Weight:	150g
Included:	USB <> RS232 Interface Cable

USB Interface Modules, #18311**Function**

The W&T Interface Modules 18311 provides an USB slave interface for devices equipped with a serial TTL port.

The Interface Module contains an integrated serial EEPROM for non-volatile storage of the Vendor ID, Product ID, Serial Number and a product description. The EEPROM is on-board programmable through the USB port.

Supply voltage

The Interface Modules require a regulated supply voltage of 5V DC $\pm 5\%$. The no-load current draw of the modules is approx. 30mA (typ.); any additional current requirement from an external load must of course be taken into account when dimensioning the power supply.

Important installation note

When installing or replacing the Interface Modules, visually inspect to ensure that the module does not cause a short circuit with adjacent components.



Pin configuration

The USB connection for the modules is configured as a female USB type B connector, with the TTL interface formatted as 12-pin male post connector. Refer to the following table for connector pin assignments:

pin#	signal	function
1	5V \pm 5%	Vcc
2	RI	input
3	TxD	output
4	RxD	input
5	n.c.	n.c.
6	DTR	output
7	CTS	input
8	DSR	input
9	RTS	output
10	DCD	input
11	12V \pm 10%	n.c.
12	GND	signal GND

Pin 1 of the TTL interface is indicated by a rectangular soldering pad.

Module diagram

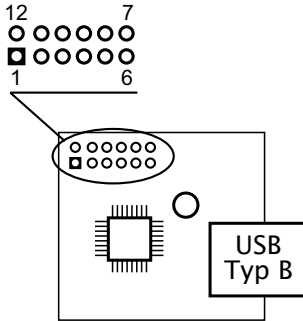

Technical Data

Standard baud rates:	300..115.200 baud
Settable baud rates:	Depending on the application and operating system, up to 3 MBaud Baud rate: $3 \text{ MHz}/n$, $n = 1..16383$
Data bits:	7 or 8
Stop bits:	1 or 2
Parity:	no, even, odd, mark, space
Supported signals:	RxD, TxD, RTS, CTS DSR, DCD, DTR, RI
Integrated FIFO:	384 Byte receive buffer 128 Byte transmit buffer
Supply voltage:	5V DC $\pm 5\%$
Supply current:	approx. 30mA
TTL connector:	12-pin, 2mm post connector
USB connector:	USB type B socket
Ambient temperature:	Storage: $-40..+70^{\circ}\text{C}$ Operating: $0..+60^{\circ}\text{C}$
Dimensions:	55 x 31 mm
Weight:	approx. 10g
Packing list:	USB Interface Module

