

Manual

Web-IO 1x Thermometer

Web-IO 2x Thermometer

Web-IO 8x Thermometer

US 1.12 10/2003 ML



Type
Model
Release

10/100BaseT, 12-24V
57601, 57603, 57604
1.12, Oct. 2003

© 10/2003 by Wiesemann & Theis GmbH

Subject to errors and modifications:

Since we can make mistakes, do our statements should not be applied without verification. Please bring any errors or misunderstandings to our attention, so that we can recognize and correct them as soon as possible.

Perform work on and with W&T products only as described here and after you have fully read and understood the manual. Unauthorized actions may result in hazardous conditions. We are not liable for unauthorized use. If in doubt, please check with us or your dealer!

Introduction

The Web-IO thermometer allows you to remotely monitor temperatures and temperature trends via Internet browser or e-Mail. You can create your own HTML pages for visualizing the temperatures and generate personal information in order to be kept informed of current temperatures.

This manual contains all the information you will need to install, configure and operate the Web-IO Thermometer.

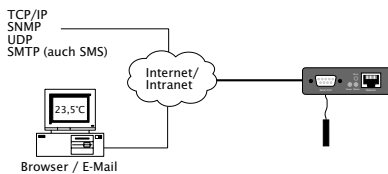
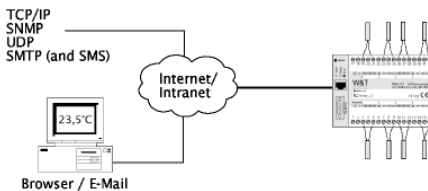

Contents

- Introduction 3
- 1 Connections and Displays 6**
 - 1.1 Ethernet connection 6
 - 1.2 Connecting the probe to the
 Web-IO 1x Thermometer 7
 - 1.3 Connecting the probes to the
 Web-IO 2x/8 Thermometer 8
 - 1.4 Supply voltage for the
 Web-IO 1x Thermometer 10
 - 1.5 Supply voltage for the
 Web-IO 2x/8 Thermometer 10
 - 1.6 LED displays 10
- 2 TCP/IP Configuration 13**
 - 2.1 Assigning the IP address 13
 - 2.1.1 ... using WuTility 13
 - 2.1.2 ... using DHCP-/BOOTP protocol 14
 - 2.1.3 ... using ARP command 16
 - 2.1.4 ... over the serial interface 17
 - 2.1.5 ... using an RARP server (UNIX only) 18
 - 2.2 Setting the subnet mask and gateway 19
 - 2.3 Connecting the Web-IO 8x Thermometer 20
- 3 Configuring the Web-IO 8x Thermometer 21**
 - 3.1 Administration 22
 - 3.1.1 LogOut 23
 - 3.1.2 New Password 24
 - 3.2 Configuration 25
 - 3.2.1 Network 26
 - 3.2.2 Text 26
 - 3.2.3 Time/Date 26
 - 3.2.4 Time Zone 26
 - 3.2.5 Time Server 27
 - 3.2.6 Device Clock 28

W&T

- 3.2.7 Mail 29
- 3.2.8 Alarm 1..8..... 30
- 3.2.9 Data Logger 32
- 3.2.10 Memory 32
- 3.2.11 Protocol 33
- 3.2.12 Enable 33
- 3.2.13 Startup 34
- 3.2.14 Ports 35
- 3.2.15 Manufacturer 35
- 3.2.16 Up-/Download 35
- 3.2.17 Diag 37

- 4 Single temperature polling... 38**
- 4.1 ... via TCP/IP 38
- 4.2 ... via UDP 39
- 4.3 ... via SNMP 39

- 5 Incorporating the temperature into your own Web Site 40**

- 6 Data Logger 42**

- 7 Appendix 43**
- 7.1 Firmware Update 43
 - 7.1.1 Where can I get the latest firmware? 43
 - 7.1.2 Firmware update over the network under Windows ... 43
- 7.2 Emergency access 45
- 7.3 Extending the NTC cable 45
- 7.4 Example of an XML configuration 47
- 7.5 Example for setting the „user.htm“ 58
- 7.6 Technical specifications 64

1 Connections and Displays

1.1 Ethernet connection

The network connection is provided in the form of an IEEE-802-3-compatible terminal on a shielded RSJ45 plug located on the front of the unit. Here the Web-IO 8x Thermometer can be connected to a hub or switch. The pin configuration corresponds to a standard MDI interface (AT&T258), so that a 1:1 cable with a length of maximum 100 meters can be used.

10BaseT, 10MBit/s or autosensing 100BaseT, 100/10MBit/s are supported:

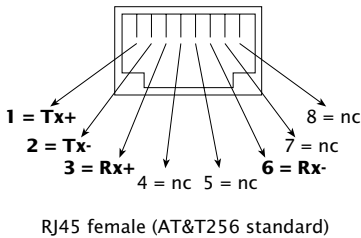

Please note that all plugs must be connected and disconnected only with the terminal devices are turned off.



Be sure that the network cable for the Web-IO does not exceed a maximum permissible length of 100m.

W&T

The Error LED on the front panel indicates the current link status: If it flashes at 1-2 second intervals, there is no connection to the hub or the connection is faulty.

1.2 Connecting the probe to the Web-IO 1x Thermometer

Connecting the NTC probe

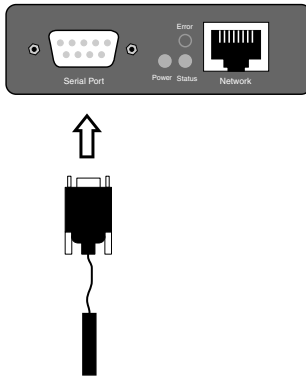

The supplied NTC probe is already preconfigured and is simply plugged into the DB9 connector in the device.

Connecting a PT100 probe

If you want to connect a PT100 probe, the pin configuration is as follows:

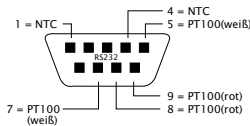

1.3 Connecting the probes to the Web-IO 2x/8 Thermometer

Connecting the NTC temperature sensors

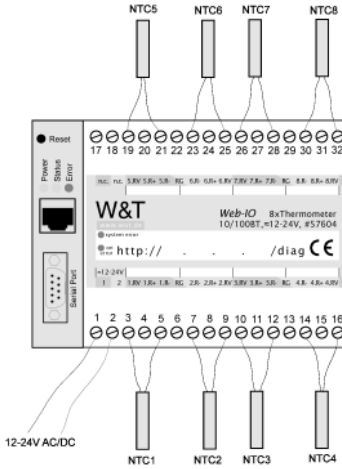

The eight NTC temperature sensors are connected to the unit as shown in the following table. The numbering corresponds to the screw terminals on the unit:

		NTC5		NTC5		NTC6		NTC6	NTC7		NTC7		NTC8		NTC8
17	18	19	20	21	22	23	24	25	26	27	28	29	30	31	32
1	2	3	4	5	6	7	8	9	10	11	12	13	14	15	16
		NTC1		NTC1		NTC2		NTC2	NTC3		NTC3		NTC4		NTC4

For information on extending the NTC cable, see Appendix (6.3).

Connecting the PT100 temperature sensors

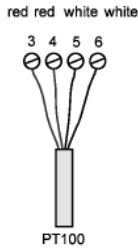

		PT100 5 red	PT100 5 red	PT100 5 white	PT100 5 u. 6 white	PT100 6 white	PT100 6 red	PT100 6 red	PT100 7 red	PT100 7 red	PT100 7 white	PT100 7 u. 8 white	PT100 8 white	PT100 8 red	PT100 8 red
17	18	19	20	21	22	23	24	25	26	27	28	29	30	31	32
1	2	3	4	5	6	7	8	9	10	11	12	13	14	15	16
		PT100 1 red	PT100 1 red	PT100 1 white	PT100 1 u. 2 white	PT100 2 white	PT100 2 red	PT100 2 red	PT100 3 red	PT100 3 red	PT100 3 white	PT100 3 u. 4 white	PT100 4 white	PT100 4 red	PT100 4 red

The cable for the PT100 4-wire temperature sensor may be routed over any desired length.

Connecting a PT100 3-wire sensor:

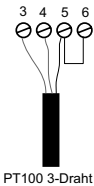

The corresponding wires of the PT100 3-wire sensor have to be connected to the screw terminals **R+** and **RV**. Connect the separate wire to the screw terminal **R-** and attach a bridge to **GND**.

Connecting a PT100 2-wire sensor:

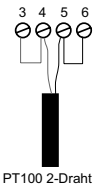

Connect one wire of the PT100 2-wire sensor to the screw terminal **R+** and the other wire to the screw terminal **R-**. Add a bridge from **R-** to **GND** and one from **R+** to **RV**.

W&T

1.4 Supply voltage for the Web-IO 1x Thermometer

Bottom 57601

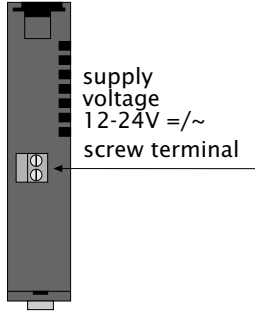

1.5 Supply voltage for the Web-IO 2x/8x Thermometer

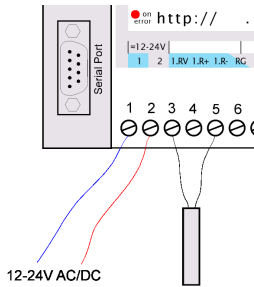

The 12-24V AC/DC supply voltage is brought to the unit on pins 1 and 2 located on the lower screw terminal block.

1.6 LED displays

- **Power-LED:** Indicates the presence of supply voltage. If the LED is not on, please check whether the power supply is properly connected.
- **Status-LED:** Flashes whenever there is network activity with the Web Thermometer. Periodic blinking indicates that the port has a connection to another station.

W&T

- **Error-LED:** The Error-LED uses various blink codes to indicate fault conditions on the device or the serial port.

Error-LED blinks 1x = Check network connection.

The Web-IO 8x Thermometer is not receiving a link pulse from a hub or switch. Check the cable or the hub/switch port.

Error-LED blinks 2x or 3x

Perform a reset by disconnecting the supply voltage or pressing the reset button. If the error is not cleared, reset the unit to the factory defaults. Since this resets all network settings, you should first write them down.

Config -> Session Control -> LogOut ->

Restore Defaults

After a reset the device is restored to its factory default settings. Make your network settings again as necessary. For more information on menu guided configuration, see section 3. and following.

Power-LED + Status-LED + Error LED on = selftest failure

The self-test, which is performed after each start or reset of the Web-IO 8x Thermometer, could not be correctly finished due to an incomplete firmware update. The device is no longer operational in this state. Please return the unit.

W&T

Supplementary LED (for internal Web-IO 1x Thermometer)

- **on error <http://xxx.xxx.xxx.xxx/diag> -LED:** Indicates internal configuration errors. For error diagnostics, open page <http://xxx.xxx.xxx.xxx/diag> in the unit.
- **system error:** Critical hardware error. Try to restart the unit by interrupting supply voltage. If the condition persists, please return the unit for evaluation.



If the Web-IO Thermometer has no IP-address or the address 0.0.0.0 the LEDs on error and system error stay on after a reset or restart! The Web-IO 1x Thermometer starts blinking for three times after a short time. After assigning a IP-address the LEDs will go off.

2 TCP/IP Configuration

Once the hardware has been configured as described above, the IP address necessary for operating in a TCP/IP network must be assigned. Please request the correct value for this parameter from your system administrator.



The IP address must be unique throughout the network.

2.1 Assigning the IP address ...

There are five ways to first assign the IP address for the Web-IO 8x Thermometer:

2.1.1 ... using WuTility

First download the „WuTility“ tool from the WuT Homepage:

(<http://www.wut.de>)

Be sure that the PC you are using to assign the IP address is in the same subnetwork as the device and that both the PC and the device are connected to the network.

- Start „WuTility“ and click on the scan icon:



- Select your Web-IO Thermometer from the displayed list using the MAC address:



W&T

The MAC address is found on the label affixed to the housing:

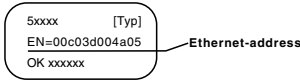

- Click on the „Assign IP Address“ symbol:



- In the resulting window, enter the desired IP address for the device and confirm with „OK“: :

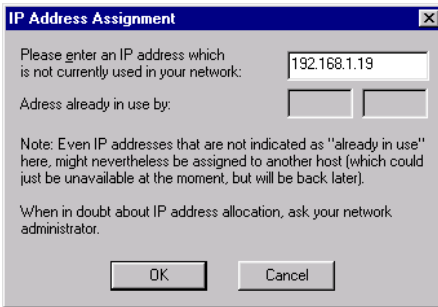

The device acknowledges the entry with an audible tone (2x/ 8x Thermometer only) and accepts the set IP address. After clicking again on the Scan button, this address is displayed in the WuTility.

2.1.2 ... using DHCP-/BOOTP protocol

Many networks use DHCP (Dynamic Host Configuration Protocol) or BOOTP for centralized and dynamic assignment of the IP addresses. Which of the two protocols are used makes not difference to the Web-IO devices, since DHCP is simply a downward compatible extension of BOOTP. DHCP servers thus also use the requirements of BOOTP clients.

W&T

The following parameters can be assigned to the Web-IO 8x Thermometer using these protocols:

- IP address
- Subnet mask
- Gateway address

It is not possible to assign other parameters or a lease time.

Functionality

To obtain an IP address, the device sends after every new start a corresponding BOOTP request as a broadcast to the network. The resulting reply generated by the DHCP/BOOTP server contains in addition to the IP address the subnet mask and gateway address. The Web-IO 8x Thermometer immediately places this information in its non-volatile memory.

When placing the unit into service in DHCP/BOOTP networks, please consult with your system administrator. If DHCP will be used for assigning the address, you must mention that a reserved IP address is required. To maintain the respective address database, the administrator needs the Ethernet address of the Web-IO 8x Thermometer, which can be found on the sticker on the housing.

Once the necessary entries have been made, the device automatically obtains the desired IP address after each reset. To ensure that the Web-IO 8x Thermometer can also be reached if the DHCP/BOOTP server fails, the previous IP address is retained if no reply follows.

W&T



In DHCP environments the IP address to be assigned must be reserved by means of a fixed link to the Ethernet address of the Web-IO 8x Thermometer. Under Windows NT this is done in the DHCP Manager under menu item „Reservations“. Linux provides the file „dhcpd.conf.“ for this purpose, in which a corresponding entry must be made.

2.1.3 ... using ARP command

The requirement is a PC which is located in the same network segment as the Web-IO 8x Thermometer and which has TCP/IP protocol installed. Read the MAC address of the device on the device (e.g.. EN=00C03D0012FF). Under Windows you first ping another network station and then insert the command line shown below into the ARP table as a static entry:

```
arp -s <IP-address> <MAC-address>
```

e.g. under Windows:

```
arp -s 172.0.0.10 00-C0-3D-00-12-FF
```

e.g. under SCO UNIX:

```
arp -s 172.0.0.10 00:C0:3D:00:12:FF
```

Next ping the device again (in our example ping 172.0.0.10). The address is now stored in non-volatile memory.



This method can only be used if no IP address has yet been assigned to the Web-IO 8x Thermometer, i.e. the entry is 0.0.0.0. To change an already existing IP address, you must open the configuration menu through telnet or select the serial path (2.1.3).

W&T

2.1.4 ... over the serial interface

In contrast to the procedure described above, you can change an already existing IP address for the Web-IO 8x Thermometer over the serial interface.

Connect the RS232 port on the unit to a PC and start a terminal program (e.g. Hyperterminal). Establish a direct connection through your COM port and set the serial properties *9600 baud, no parity, 8 bits, 1 stop bit, no protocol*. Perform a reset by interrupting the supply voltage on the unit. When the green Status LED comes on, enter (on the terminal) the letter „x“ at least three times until the message „*IPno.+<Enter>*“ appears. Now enter the IP address in the usual decimal format (xxx.xxx.xxx.xxx) and confirm your entry with *<Enter>*.



Backspacing will not correct an error in entering text. The procedure must be repeated.

If the entry was correct, the assigned IP address is acknowledged, otherwise the monitor shows the current IP address along with the message „*FAIL*“. This procedure may be repeated as often as desired.

If you want to shut down the BOOTP (DHCP) functionality in this status directly, type a „-0“ behind the IP-address (192.168.5.12-0).

You will need a null modem cable for connecting to a terminal:

```
xxx                -> Web-IO Thermometer
IP no.+<ENTER>:   <- Web-IO Thermometer
172.17.231.99-0   -> Web-IO Thermometer
172.17.231.99     <- Web-IO Thermometer
```

W&T

A crossed serial cable is needed to connect the device to a terminal:

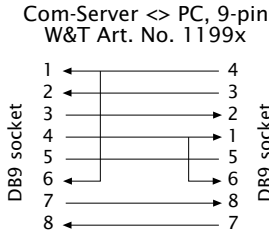

2.1.5 ... using an RARP server (UNIX only)

Working with an RARP server activated under UNIX is based on entries in the configuration files `/etc/ethers` and `/etc/hosts`. First add a line to `/etc/ethers` with the allocation of the Ethernet address of the Web-IO 8x Thermometer to the desired IP address. In `/etc/hosts` the link with an alias name is then created. Once you have connected the device in the network segment of the RARP server, you can assign the desired IP address over the network.

Example:

Your Web-IO 8x Thermometer has MAC address EN=00C03D0012FF (sticker on the unit). You want it to have IP address 172.0.0.10 and the alias name WT_1.

Entry in file `/etc/hosts`: 172.0.0.10 WT_1

Entry in file `/etc/ethers`: 00:C0:3D:00:12:FF WT_1

If the RARP daemon is still not activated, you must start it using the command „`rarpd -a`“.

W&T

2.2 Setting the subnet mask and gateway

When working in routed environments, the Web-IO Thermometer must also be told which subnet mask is valid for the respective network segment and which router is being employed. You can obtain the valid values for both parameters from your system administrator.

The subnet mask and gateway can be set after assigning the IP address using the Web-Based Management tool (3.2.1).



To make the subnet mask and gateway settings, the configuration PC must be located in the same IP sub-network as the Web-IO Thermometer. Otherwise no communication with the device will be possible.

Once you have assigned the IP address, set the subnet mask and gateway as follows:

1. Open a Web browser and enter the IP address of the device in the address line.
2. Select Config. in the configuration menu
3. Since no password has yet been assigned, leave this line blank and confirm by clicking on the Login button and then „OK“.
4. Select the following path in the menu:

Config -> Device -> Network

5. Now enter the subnet mask and gateway and confirm using the Send button.

W&T

6. Select the following path in the menu:

Config -> Session Control -> LogOut

and click on the Save button.

The device has now saved your settings.

2.3 Connecting the Web-IO 8x Thermometer

In an Intranet

Once all the settings have been made, the Web-IO 8x Thermometer can be accessed through any desired Web browser. Enter as an address the IP address or (if you have specified a corresponding DNS entry) the host name for the device. The device will then send its information back to the browser.

In the Internet

To make the Web-IO 8x Thermometer accessible from the Internet, you will need a free, external and static IP address which your router can reach from the Internet. Ask your ISP to provide you with a DNS entry so that the Web Thermometer can be accessed by means of a URL. Then you need only to divert HTTP port 80 in your router to the IP address of the Web-IO 8x Thermometer. This is done by means of an entry in the NAT table, such as:

`http 172.0.0.10`

3 Configuring the Web-IO 8x Thermometer

Once all the hardware settings are made, you can go to the Web configuration of the Web-IO 8x Thermometer. Start a Web browser and in the address line enter the IP address of the device:

http://172.0.0.10/

The Web-IO 8x Thermometer starts with the following display:

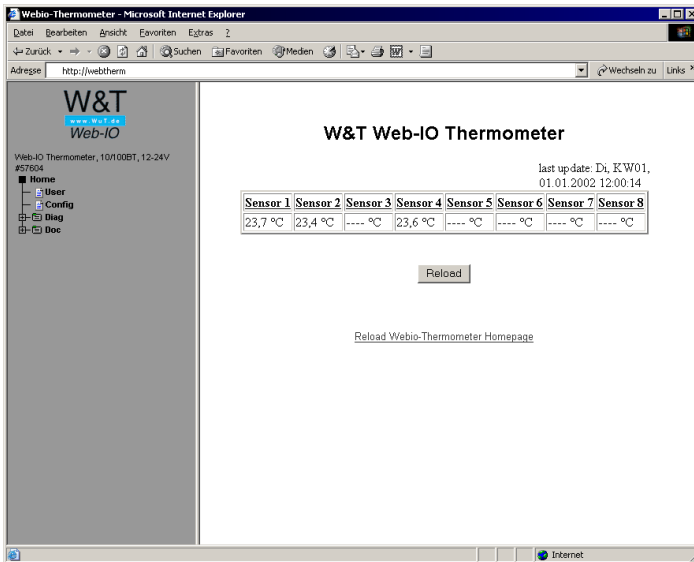

After clicking on „Login“ in the menu, you are asked to enter a password.



The unit is shipped with no password assigned. Simply click on the „Login“ button in the right frame and confirm with the „OK“ button to start the configuration.

W&T

You are shown the following menu tree for configuring the device:

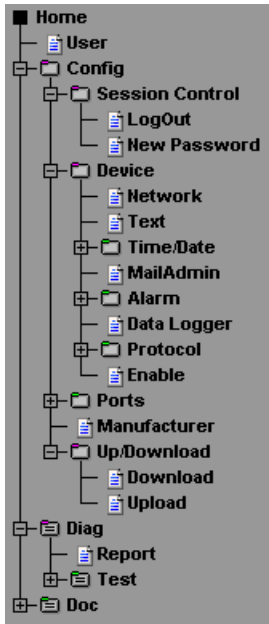

3.1 Administration

To administrate the Web-IO Thermometer, select „Session Control“ in the menu.

W&T

3.1.1 LogOut



Here you will find the following functions:

Save saves all the settings and changes you have made. (Must also be done after clicking the „Send“ button.)

Flush cancels all the settings you have made during this session. No changes are saved.

Restore Defaults resets the Web-IO 8x Thermometer. See also XML-Up-/Download (3.2.14).



Any user pages that may be stored are also lost.

Firmware Update opens the update port. Now you can run an update of the module firmware.

W&T

3.1.2 New Password



You can assign two different passwords to the device in order to protect certain areas of the configuration. A distinction is made between the following users:

- Admin (all configuration rights)
- Config (e.g. house technician: no network internals)



Only one user can be in the configuration mode. If there is already a user in configuration mode, only the Admin user has authorization to start a new configuration session. The previous session is then quit without saving.

If you do not assign a password for one or both users, all functions are available to these users. If for example you assign a password for the Config user but none for the Admin, the Admin parameters will also be displayed when logging in to Config, as long as these parameters are not password protected.

Passwords may have a maximum of 30 characters.

W&T



If no password is entered in the line and the „Send“ button is activated, the current password will be deleted after saving.

3.2 Configuration

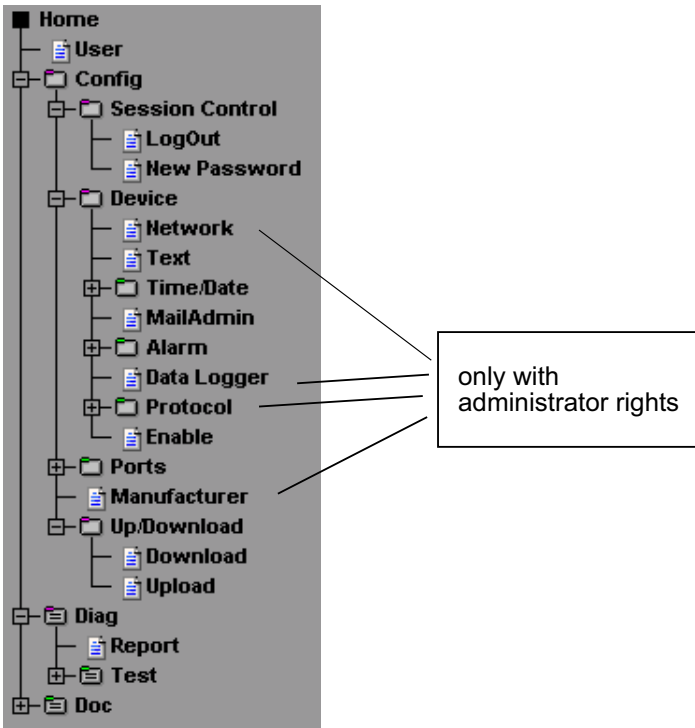

W&T

3.2.1 Network

Once you have assigned the IP address and are able to access the unit from your browser, you can now make the network settings after the fact. If you want to use host names instead of IP addresses in the mail configuration (3.2.7) or in the time server function (3.2.5), you can specify two DNS servers here which can resolve these host names.



The BOOTP-Client (DHCP) can be turned off if there is any problem with the IP-address assignement.

3.2.2 Text

Enter here a name and descriptive text that you want to appear on the start page.

3.2.3 Time/Date

Set the current time of day and date. These settings are applied immediately and do not need to be saved.



After a device reset these settings are also reset.

3.2.4 Time Zone

Next configure the time zone. This is preset to Central European Time (CET) with an offset of +1 hour from GMT.

Likewise you can make settings for switching back and forth between daylight savings and standard time. Here again enter the offset to GMT and enter the start and stop time for daylight savings time.

W&T

Example for the start time:

Month: March

Mode: last

Weekday: Sunday

Time: 02:00

This means that summer time begins on the last Sunday in March at 02:00 in the morning.

Configure the stop time in just the same way.



Be sure that in the Device Properties (Config -> Device -> Enable) the checkboxes „Apply Timezone“ and „Apply Summertime“ are activated if you wish to use these functions.



The rule for specifying summer time: Start: On last Sunday in March at 02:00 hours. End: On last Sunday in October at 03:00 hours.

3.2.5 Time Server

The Web-IO Thermometer supports access to time servers. These make it possible to obtain the time of day over the Internet or Intranet. This time can be used directly by the Web-IO Thermometer.

Enter here the IP address or host name of the time server(s). If you want to use a host name for a time server, please enter one or two DNS servers (IP address) so that this host name can be resolved. Alternately, the IP address of one or two time servers can be entered. In this case you do not need an entry for the DNS server.

W&T

The time sent by the time server is always GMT, which means that you still have to make the settings for your time zone and daylight savings time in order to ensure a correct time display.



Access to the time server takes place after saving the settings, after turning on or resetting the device, and at the configured full hour. Be sure that the checkbox „Apply TimeServer“ is activated under Device Properties (Config->Device->Enable).

Successful synchronization is indicated by the display with a „*“ behind the time of day on the home or user page.

A listing of public time servers can be found at:

<http://www.eecis.udel.edu/~mills/ntp/servers.html>

3.2.6 Device Clock

Here you set the time of day if the device is not using the time server functionality. These settings are lost as soon as the device is disconnected from power.

W&T

3.2.7 Mail

Here you configure the e-Mail function of the Web-IO Thermometer. The e-Mail function allows you to forward an information or alarm mail to one or more e-Mail or SMS recipients.

Enter the name you want to appear at the e-Mail recipient. Now the reply address is set which the Web-IO Thermometer uses to identify itself.



Some mail servers require a login by the e-Mail user in order to identify him. It may be necessary to enter an existing mailbox so that an SMTP access is accepted. If there are problems in accessing the mail server, you may have to create a new mailbox for the Web-IO Thermometer.

In the next step, set the IP address of your mail server or its host name which the device should refer to. If the e-Mail port does not correspond to the standard port 25, you can append a colon to the address:

mail.provider.com:476

Be sure that „Mail enable“ is set under Device Properties (Config -> Device -> Enable).

3.2.8 Alarm 1..8

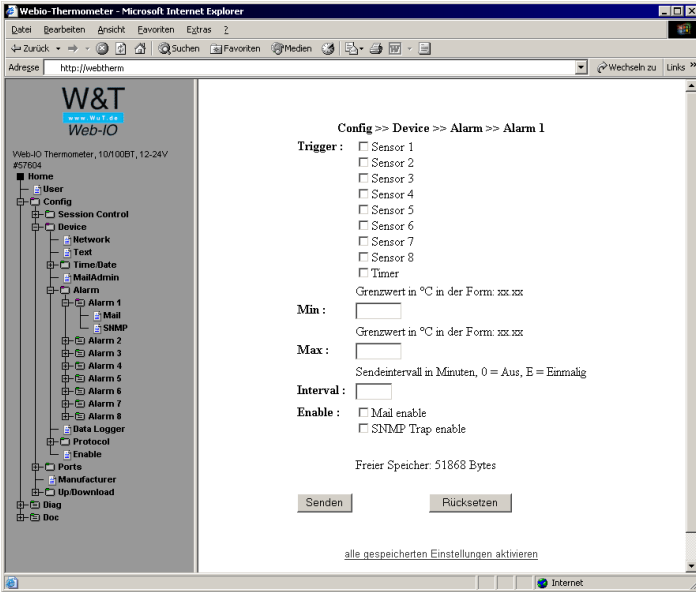

Eight equal alarms are available with two operating modes:

1. Timer mode:

Select the timer under Trigger. Limits do not need to be specified at this point. Set the desired send interval and select „Mail enable“ and/or „SNMP Trap enable“.

W&T

2. Limit mode:

Select one or more sensors as triggers and after Min and/or Max enter the limits which when exceeded should trigger an alarm. Enter the send interval at which the alarm e-Mail should be sent. For no alarm, enter a send interval of 0. Entering an E means that an alarm is triggered whenever the limit is exceeded (high or low). The temperature measurement is made each full minute. If a limit is violated for the first time, the alarm is triggered directly. As long as the temperature is still not within the valid range, successive alarms are issued at the specified intervals.



You can also mix the operating modes. Note however that an alarm is triggered asynchronous to the interval and the interval for the alarm time is restarted.

Now specify whether the alarm is to be sent as an e-Mail or SNMP trap.

Mail

The „Mail-Text“ is variable. To include temperatures in the text, use the expression „<Tx>“, where x is the number of the temperature sensor. All the sensors can be displayed regardless of the „Trigger“ settings. To display the time and date information, use the expression „<Z>“.

Specify the e-Mail address of the recipient. To configure multiple recipients, separate their e-Mail addresses with semicolons. Specify an entry for the „Subject“ field.

W&T

SNMP

Enter here the IP address of the station with the SNMP Manager software to which the SNMP information should be sent.

Just as in the case of the mail function, you can also enter here a „Trap Text“ which is sent to the Manager software. This has the same entry format as the mail text.



If you have entered an administrator password, you must enter this in your Manager software as the „community string“!

3.2.9 Data Logger

Under „Timebase“ enter the desired memory frequency and under „Select Sensor“ select the sensors whose measurements you want to store. Both settings have an effect on the memory depth of the unit. For example, after activating all eight sensors with a time base of 15 min. you will have a memory depth of 85 days and 7 hours. The measured values will stay in a fixed ring-buffer in the device and will be available even after a reset or a power-off. Read more about the data logger on page 42.

3.2.10 Memory

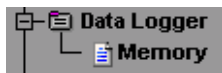

After choosing this menu item and after a click on the „Erase memory“ button all measured values which have been saved in the device will be erased.

W&T

3.2.11 Protocol

This function is used to save the individual data on separate servers or directly to your own applications without using the Web interface.

Enter here a UDP port the device uses for listening and answering. The default setting is port ,42279‘.

3.2.12 Enable

Here the global functions of the device are activated and deactivated:

Update Enable for the update port can be turned on or off. If it is activated, it is possible to load the firmware update into the device. Regardless of this setting the Web-IO 8x Thermometer can be opened for an update under „LogOut -> Firmware Update“.

Mail Enable Activates or deactivates the e-Mail function

SNMP Enable Activates or deactivates the SNMP function

UDP Enable Activates access to the temperature via UDP.

GET Single Header Enable A GET /Single request means that the device sends the configured name and IP address of the device in addition.

Apply Timezone Local time is used. This means that the device calculates the entered offset to GMT. If this function is disabled, no offset is used.

W&T

Apply Summertime Activates summer time (daylight saving time). This function works only in conjunction with **Apply Timezone**.

Apply Time Server Activates the use of a time server for setting the time of day. Enter at least one time server so that this function will work.

Startup selects the page which will be displayed as default when using the web browser.

3.2.13 Startup

Here you can choose which web-page will be loaded when there is no further page information typed after the address. The standard page is „index.htm“, as it is the internet.

Sometimes some applications need to load different pages on startup e.g. to hide the configuration menu. It is also possible to load the pages by typing the address directly for „user.htm“ or „log.htm“.

The pages will not be lost at this choice and they are loadable with the explicit address on every time.

The changes will be made after saving the configuration.



After a factory default reset the startup-page will be „index.htm“ again.

W&T

3.2.14 Ports

If desired, you can assign a name and descriptive text for the individual sensors which you want to have displayed on the Web pages.

3.2.15 Manufacturer

This contains information about the manufacturer and the company providing the support. Change this information only if you can and want to assume support responsibility.

In addition, you can change the logo in the menu frame here. Simply enter the path to your logo file in this text field. This may be a local or external path.

3.2.16 Up-/Download

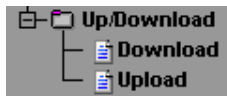

In the download area you can download the XML configuration as well as the three user pages (home.htm, user.htm, log.htm) for further editing.

Here you can load the settings for the Web-IO Thermometer into the device using **XML Upload**. To read out the current configuration, click on **XML Download**.

With some Web browsers the correct code can be output using „Display View -> (Frame-) source text“ only after clicking on the XML Download button.

W&T

For the XML upload you create a text file with the corresponding parameters and load this file into the device. Your configuration must begin with the expression

```
<io-AN8.1>
```

and end with the expression

```
</io-AN8.1>
```

The sequence of the parameters to be set corresponds to the order in which they appear in the configuration menu starting with „Device“.

The syntax for configuring using XML is as follows:

```
<Option>  
  <Parameter1> VALUE </Parameter1>  
  <Parameter2> VALUE </Parameter2>  
</Option>
```

The individual options and parameters correspond to the configuration items in the browser menu.



Please note, especially for mass updates and configurations, that the IP address stored in the XML file is also always sent and then needs to be matched.

An example can be found in the Appendix (6.4).

In addition, the user pages (user.htm, home.htm, log.htm) can be exchanged in the **Upload** area.

An example can be found in the Appendix (6.5).

The menu item „**Upload** -> **GIF**“ can be used to replace the logo displayed in the menu and then directly stored in the unit.

W&T

3.2.17 Diag

In this area the device displays all the gathered errors under *Report*. You can identify the error here with activity on the *on Error http* LED.

Report

If the „**on error http**“ LED on the unit is flashing, this error is entered in a list on the Report page.

This page reports all errors which the device can output.

Deleting the report also resets the flashing LED on the unit's front panel.

Clicking the OK button saves the report. The LED continues to flash.

Sensor Type

Indicates for each channel whether a PT100 or NTC sensor is connected. If one or more channels is used, an NTC is indicated by default.

Test LED

The Test LED allows you to locate a device when more than one is being used. When the LED test is started, the LED's on the device will come on for two seconds.

4 Single temperature polling...

4.1 ... via TCP/IP

As a special function it is possible to use a socket connection to manually poll the current temperature values in CSV format (comma-separated data).

Send the following to port 80 on the device:

```
GET /Thermo.csv
```

To get the single current temperature value, send:

```
GET /Single1
```

where the number behind „Single“ is the number of the sensor (Sensor 1 - Sensor 8)

```
GET /Single4
```

thus provides the temperature from Sensor 4.

To output all temperatures at once, send the expression:

```
GET /Single
```

(Equal with “GET /Single1” for the Web-IO 1x Thermometer)

W&T

4.2 ... via UDP

Open a UDP connection to the IP address of the unit or to the Net ID as a broadcast and to port 42279 (default can be changed).

Then send the device one of the expressions listed under 4.1 and the device will return the temperature on the port you are using.



When using more than one device, it may be useful in the case of broadcast sends to allow the name and the device IP address to be output as well. To do this, activate „GET Single Header enable“ in the global settings (3.2.11).

4.3 ... via SNMP

The individual sensors can be directly polled using SNMP Get instructions. You reach the sensors of the thermometer through the following path:

<IP-address> 1.3.6.1.4.1.5040.1.2.1.1.1.0 = number of sensors

<IP-address> 1.3.6.1.4.1.5040.1.2.1.1.3.1.1.x = temperature value, where x is the sensor number.

<IP-address> 1.3.6.1.4.1.5040.1.2.1.1.4.1.1.x = temperature value three-digit integer number, without comma separation, where x is the sensor number.

The OID for the 2x thermometer is:

<IP-address> 1.3.6.1.4.1.5040.1.2.2....

The OID for the 1x thermometer is:

<IP-address> 1.3.6.1.4.1.5040.1.2.3....



If you have entered an administrator password, you must enter this in your Manager software as the „community string“!

An MIB for incorporating into Management applications can be found and downloaded from the datasheet page at the WuT Homepage <http://www.wut.de>.

5 Incorporating the temperature into your own Web Site

It is possible to integrate the temperature on your own Web site using an implemented Java applet. An example for this applet is already contained in the unit:

<http://172.0.0.10/app.htm>

To incorporate the applet for temperature monitoring into the HTML page, you must insert the following HTML tag at the point where the applet is inserted:

```
<APPLET ARCHIVE="A.jar" CODE="A.class" Codebase="Http://WebTherm/"  
Width="width" Height="height">
```

Now the following parameters can be optionally specified:

Specifying the background color:

```
<Param Name="BGColor" Value="#RGB-value">
```

Specifying the font color:

```
<Param Name="FGColor" Value="#RGB-value">
```



The RGB value is specified as a 24-bit Hex value. e.g.: Value="#2F3C09" Upper and lower case are not critical.

Specifying text alignment:

```
<Param Name="Align" Value="const">
```

W&T

const must be one of the following constants:

- Left
- Center
- Right

Upper and lower case are not critical.

If a parameter is omitted or incorrectly used, the following standard values are applied:

BGColor	#FFFFFF (white)
FGColor	#000000 (black)
Align	Right

Once all the parameters are entered, you must close the HMTMP tag with `</Applet>`

Example:

```
<Applet ARCHIVE="A.jar" CODE="A.class"  
Codebase="http://127.0.0.1" Width="300" Height="100">  
<Param Name="BGColor" Value="#0000FF">  
<Param Name="FGColor" Value="#FF0000">  
<Param Name="Align" Value="Center">  
</Applet>
```

The font size is automatically calculated from the size of the applet. The font is proportionally enlarged until it fits into the applet in height and/or width.

The applet is updated every 60s

6 Data Logger

The measured values will stay in a fixed ring-buffer in the device and will be available even after a reset or a power-off.



The values of the data logger can be viewed via the user-page in the device (home -> user or <http://xxx.xxx.xxx.xxx/user.htm>).

The menu item *config -> device -> data logger -> memory* gives you the possibility to erase the logger memory.

A interruption of the time line e.g. after a reset or a subsequent time server synchronization will be displayed as a yellow line in the log table.

14.10.2003	Di	08:46	23,1	23,0	23,0	23,3
14.10.2003	Di	08:47	23,1	23,0	23,0	23,3
14.10.2003	Di	08:46	23,1	23,0	23,0	23,3
14.10.2003	Di	08:45	23,0	23,0	23,0	23,3
01.01.2002	Di	12:08	23,0	22,9	22,9	23,2
01.01.2002	Di	12:07	23,0	23,0	22,9	23,2
01.01.2002	Di	12:06	22,9	22,9	22,8	23,1
01.01.2002	Di	12:05	22,9	22,8	22,8	23,1
01.01.2002	Di	12:04	22,9	22,9	22,9	22,1

time line interruption:
yellow marked line

7 Appendix

7.1 Firmware Update

The firmware for the Web-IO Thermometer is under constant further development. The following section describes how to upload the newest firmware.

- Where can I get the latest firmware?
- Firmware update over the network under Windows

7.1.1 Where can I get the latest firmware?

The latest firmware including the available update tools and a revision list is published on our Web pages at: *<http://www.wut.de>*

Before downloading, please write down the 5-digit model number located on a sticker on the Web-IO Thermometer. From for Homepage you can now reach the product overview sorted by article numbers, from which you can go directly to the data sheet for the device. From here follow the link to the current firmware version.

7.1.2 Firmware update over the network under Windows

Required is a PC under Windows 9x/NT/2000/XP having a network connection and activated TCP/IP stack. For the update process you will need two files which are available for downloading at the Homepage *<http://www.wut.de>* .

W&T

- The executable update tool for loading the firmware into the Web-IO Thermometer.
- The file with the new firmware that is loaded into the Web-IO Thermometer.

No special preparation of the Web-IO Thermometer is necessary in order to perform the firmware update.

The *WuTility* used for the update detects all the WuT devices in your network and is for the most part self-explanatory. If you still have questions or are unclear about anything, please use the associated documentation or on-line help.



Never intentionally interrupt the update process by disconnecting the supply voltage or pressing the Reset button. Following an incomplete update the Web-IO Thermometer will be incapable of operating.

Never mix files of various version numbers in the file name. This will result in inoperability of the device.

The Web-IO Thermometer automatically detects when transmission of the new firmware is complete and then independently performs a reset.

W&T

7.2 Emergency access

The serial connection (DTE) on the unit provides an emergency access. This is enabled as follows:

Use a serial cable to connect the unit to a PC (null modem connection) and start a serial terminal program. Configure the program for

9600,8,N,1,no handshake

Press the Reset button on the unit. As soon as the signal tone is audible, press the following letters on your keyboard 3x for the individual accesses:

3x „u“ Opens the update port. A firmware update can now be performed.

3x „f“ Resets the unit to its factory default settings. All previous configurations and settings (including the IP address) are lost.

3x „p“ Deletes all assigned passwords.

For confirmation the **System Error** and the **on error http** LED's flash multiple times in succession.

3x „x“ (Enter directly after pressing the Reset button and before the signal tone) Assigning/changing the IP address. When prompted, enter the desired IP address.

7.3 Extending the NTC cable

If necessary the NTC sensor cable can be extended. Recommended is a cable with as large a gauge as possible (at least 0.75²mm or AWG 18) in order to ensure that the cable impedance is not too great (below 10 ohms), which would falsify the measured values.

W&T

Using a copper cable with a cross-section of 0.75mm² and a length of 100m, the cable impedance will be 4.6 ohms, which is within the tolerance range.

For copper cables verify the impedance using the following formula:

$$R_L = \frac{2 \cdot \text{length [m]}}{58 \cdot \text{cross section [mm}^2\text{]}}$$

The result of this calculation must lie below 10 ohms.

More critical than the cable length are the external noise effects on the cable. This can result in inaccurate readings. Be sure therefore that the cable is isolated from other installations and thus not subjected to electromagnetic radiation. Twisted-pair cable (e.g. Cat.5) will also help to suppress noise.



The accuracy and noise immunity of the sensors depend on the cable length and any noise sources which may be present. This means that the local conditions of some installations may, if not rectified, result in measuring errors or inaccuracies. For a new installation, we recommend using a 4-conductor cable in order to allow for later use of PT100 technology.

We have taken a number of steps in order to ensure that noise sources such as 50Hz interference from the AC cable does not have an effect on the measured values. You can easily check to see how effective our noise suppression is working in your environment by using fixed resistors instead of NTC sensors. The measured values should in this case fluctuate by a maximum of 1 decimal point.

W&T

7.4 Example of an XML configuration

To easily edit the XML configuration, you should first download the current configuration from the unit and then edit this file.

```
<io-AN8.2>
  <Device>
    <Network>
      <IP_Addr>0.0.0.0</IP_Addr>
      <Subnet_Mask>255.00.00.00</Subnet_Mask>
      <Gateway>00.00.00.00</Gateway>
      <BOOTPClient>
        <BOOTP_disable>OFF</BOOTP_disable>
      </BOOTPClient>
      <DnsServer1></DnsServer1>
      <DnsServer2></DnsServer2>
    </Network>
    <Text>
      <DeviceName>W&amp;T Web-IO Thermometer</DeviceName>
      <DeviceText> </DeviceText>
    </Text>
    <Time_Date>
      <TimeZone>
        <Name>MEZ</Name>
        <GMToffset>01:00</GMToffset>
        <Summertime>
          <Name>MESZ</Name>
          <GMToffset>02:00</GMToffset>
          <Start>
            <Month>
              <January>OFF</January>
              <February>OFF</February>
              <March>ON</March>
              <April>OFF</April>
              <May>OFF</May>
              <June>OFF</June>
              <July>OFF</July>
              <August>OFF</August>
              <September>OFF</September>
              <October>OFF</October>
            </Month>
          </Start>
        </Summertime>
      </TimeZone>
    </Time_Date>
  </Device>
</io-AN8.2>
```

```
<November>OFF</November>
<December>OFF</December>
</Month>
<Mode>
  <first>OFF</first>
  <second>OFF</second>
  <third>OFF</third>
  <fourth>OFF</fourth>
  <last>ON</last>
</Mode>
<Weekday>
  <Sunday>ON</Sunday>
  <Monday>OFF</Monday>
  <Tuesday>OFF</Tuesday>
  <Wednesday>OFF</Wednesday>
  <Thursday>OFF</Thursday>
  <Friday>OFF</Friday>
  <Saturday>OFF</Saturday>
</Weekday>
<Time>02:00</Time>
</Start>
<Stop>
  <Month>
    <January>OFF</January>
    <February>OFF</February>
    <March>OFF</March>
    <April>OFF</April>
    <May>OFF</May>
    <June>OFF</June>
    <July>OFF</July>
    <August>OFF</August>
    <September>OFF</September>
    <October>ON</October>
    <November>OFF</November>
    <December>OFF</December>
  </Month>
  <Mode>
    <first>OFF</first>
    <second>OFF</second>
    <third>OFF</third>
    <fourth>OFF</fourth>
```

W&T

```
        <last>ON</last>
    </Mode>
    <Weekday>
        <Sunday>ON</Sunday>
        <Monday>OFF</Monday>
        <Tuesday>OFF</Tuesday>
        <Wednesday>OFF</Wednesday>
        <Thursday>OFF</Thursday>
        <Friday>OFF</Friday>
        <Saturday>OFF</Saturday>
    </Weekday>
    <Time>03:00</Time>
</Stop>
</Summertime>
</TimeZone>
<TimeServer>
    <UTCServer1>ntp0.fau.de</UTCServer1>
    <UTCServer2>ri.ntp.carnet.hr</UTCServer2>
    <SyncTime>0</SyncTime>
</TimeServer>
<DeviceClock>
    <Time>12:00</Time>
    <Day>01</Day>
    <Month>01</Month>
    <Year>2002</Year>
</DeviceClock>
</Time_Date>
<MailAdmin>
    <Name></Name>
    <ReplyAddr>-@no.reply</ReplyAddr>
    <MailServer></MailServer>
</MailAdmin>
<Alarm>
    <Alarm1>
        <Trigger>
            <Sensor_1>OFF</Sensor_1>
            <Sensor_2>OFF</Sensor_2>
            <Sensor_3>OFF</Sensor_3>
            <Sensor_4>OFF</Sensor_4>
            <Sensor_5>OFF</Sensor_5>
            <Sensor_6>OFF</Sensor_6>
```

```
<Sensor_7>OFF</Sensor_7>
<Sensor_8>OFF</Sensor_8>
<Timer>OFF</Timer>
</Trigger>
<Min></Min>
<Max></Max>
<Interval></Interval>
<AlarmEnable>
  <Mail_enable>OFF</Mail_enable>
  <SNMP_Trap_enable>OFF</SNMP_Trap_enable>
</AlarmEnable>
<Mail1>
  <E-Mail-Addr></E-Mail-Addr>
  <Subject></Subject>
  <Mailtext>Actual temperature: &lt;Tl&gt; °C</Mailtext>
</Mail1>
<SNMP1>
  <Manager_IP></Manager_IP>
  <TrapText>&lt;Tl&gt;;</TrapText>
</SNMP1>
</Alarm1>
<Alarm2>
  <Trigger>
    <Sensor_1>OFF</Sensor_1>
    <Sensor_2>OFF</Sensor_2>
    <Sensor_3>OFF</Sensor_3>
    <Sensor_4>OFF</Sensor_4>
    <Sensor_5>OFF</Sensor_5>
    <Sensor_6>OFF</Sensor_6>
    <Sensor_7>OFF</Sensor_7>
    <Sensor_8>OFF</Sensor_8>
    <Timer>OFF</Timer>
  </Trigger>
  <Min></Min>
  <Max></Max>
  <Interval></Interval>
  <AlarmEnable>
    <Mail_enable>OFF</Mail_enable>
    <SNMP_Trap_enable>OFF</SNMP_Trap_enable>
  </AlarmEnable>
  <Mail2>
```

W&T

```
<E-Mail-Addr></E-Mail-Addr>
<Subject></Subject>
<Mailtext>Actual temperature: &lt;Tl&gt; °C</Mailtext>
</Mail2>
<SNMP2>
  <Manager_IP></Manager_IP>
  <TrapText>&lt;Tl&gt;</TrapText>
</SNMP2>
</Alarm2>
<Alarm3>
  <Trigger>
    <Sensor_1>OFF</Sensor_1>
    <Sensor_2>OFF</Sensor_2>
    <Sensor_3>OFF</Sensor_3>
    <Sensor_4>OFF</Sensor_4>
    <Sensor_5>OFF</Sensor_5>
    <Sensor_6>OFF</Sensor_6>
    <Sensor_7>OFF</Sensor_7>
    <Sensor_8>OFF</Sensor_8>
    <Timer>OFF</Timer>
  </Trigger>
  <Min></Min>
  <Max></Max>
  <Interval></Interval>
  <AlarmEnable>
    <Mail_enable>OFF</Mail_enable>
    <SNMP_Trap_enable>OFF</SNMP_Trap_enable>
  </AlarmEnable>
  <Mail3>
    <E-Mail-Addr></E-Mail-Addr>
    <Subject></Subject>
    <Mailtext>Actual temperature: &lt;Tl&gt; °C</Mailtext>
  </Mail3>
  <SNMP3>
    <Manager_IP></Manager_IP>
    <TrapText>&lt;Tl&gt;</TrapText>
  </SNMP3>
</Alarm3>
<Alarm4>
  <Trigger>
    <Sensor_1>OFF</Sensor_1>
```

```
<Sensor_2>OFF</Sensor_2>
<Sensor_3>OFF</Sensor_3>
<Sensor_4>OFF</Sensor_4>
<Sensor_5>OFF</Sensor_5>
<Sensor_6>OFF</Sensor_6>
<Sensor_7>OFF</Sensor_7>
<Sensor_8>OFF</Sensor_8>
<Timer>OFF</Timer>
</Trigger>
<Min></Min>
<Max></Max>
<Interval></Interval>
<AlarmEnable>
  <Mail_enable>OFF</Mail_enable>
  <SNMP_Trap_enable>OFF</SNMP_Trap_enable>
</AlarmEnable>
<Mail4>
  <E-Mail-Addr></E-Mail-Addr>
  <Subject></Subject>
  <Mailtext>Actual temperature: &lt;Tl&gt; °C</Mailtext>
</Mail4>
<SNMP4>
  <Manager_IP></Manager_IP>
  <TrapText>&lt;Tl&gt; </TrapText>
</SNMP4>
</Alarm4>
<Alarm5>
  <Trigger>
    <Sensor_1>OFF</Sensor_1>
    <Sensor_2>OFF</Sensor_2>
    <Sensor_3>OFF</Sensor_3>
    <Sensor_4>OFF</Sensor_4>
    <Sensor_5>OFF</Sensor_5>
    <Sensor_6>OFF</Sensor_6>
    <Sensor_7>OFF</Sensor_7>
    <Sensor_8>OFF</Sensor_8>
    <Timer>OFF</Timer>
  </Trigger>
  <Min></Min>
  <Max></Max>
  <Interval></Interval>
```

W&T

```
<AlarmEnable>
  <Mail_enable>OFF</Mail_enable>
  <SNMP_Trap_enable>OFF</SNMP_Trap_enable>
</AlarmEnable>
<Mail5>
  <E-Mail-Addr></E-Mail-Addr>
  <Subject></Subject>
  <Mailtext>Actual temperature: &lt;Tl&gt; °C</Mailtext>
</Mail5>
<SNMP5>
  <Manager_IP></Manager_IP>
  <TrapText>&lt;Tl&gt;</TrapText>
</SNMP5>
</Alarm5>
<Alarm6>
  <Trigger>
    <Sensor_1>OFF</Sensor_1>
    <Sensor_2>OFF</Sensor_2>
    <Sensor_3>OFF</Sensor_3>
    <Sensor_4>OFF</Sensor_4>
    <Sensor_5>OFF</Sensor_5>
    <Sensor_6>OFF</Sensor_6>
    <Sensor_7>OFF</Sensor_7>
    <Sensor_8>OFF</Sensor_8>
    <Timer>OFF</Timer>
  </Trigger>
  <Min></Min>
  <Max></Max>
  <Interval></Interval>
  <AlarmEnable>
    <Mail_enable>OFF</Mail_enable>
    <SNMP_Trap_enable>OFF</SNMP_Trap_enable>
  </AlarmEnable>
  <Mail6>
    <E-Mail-Addr></E-Mail-Addr>
    <Subject></Subject>
    <Mailtext>Actual temperature: &lt;Tl&gt; °C</Mailtext>
  </Mail6>
  <SNMP6>
    <Manager_IP></Manager_IP>
    <TrapText>&lt;Tl&gt;</TrapText>
```

```
</SNMP6>
</Alarm6>
<Alarm7>
  <Trigger>
    <Sensor_1>OFF</Sensor_1>
    <Sensor_2>OFF</Sensor_2>
    <Sensor_3>OFF</Sensor_3>
    <Sensor_4>OFF</Sensor_4>
    <Sensor_5>OFF</Sensor_5>
    <Sensor_6>OFF</Sensor_6>
    <Sensor_7>OFF</Sensor_7>
    <Sensor_8>OFF</Sensor_8>
    <Timer>OFF</Timer>
  </Trigger>
  <Min></Min>
  <Max></Max>
  <Interval></Interval>
  <AlarmEnable>
    <Mail_enable>OFF</Mail_enable>
    <SNMP_Trap_enable>OFF</SNMP_Trap_enable>
  </AlarmEnable>
  <Mail7>
    <E-Mail-Addr></E-Mail-Addr>
    <Subject></Subject>
    <Mailtext>Actual temperature: &lt;Tl&gt; °C</Mailtext>
  </Mail7>
  <SNMP7>
    <Manager_IP></Manager_IP>
    <TrapText>&lt;Tl&gt;</TrapText>
  </SNMP7>
</Alarm7>
<Alarm8>
  <Trigger>
    <Sensor_1>OFF</Sensor_1>
    <Sensor_2>OFF</Sensor_2>
    <Sensor_3>OFF</Sensor_3>
    <Sensor_4>OFF</Sensor_4>
    <Sensor_5>OFF</Sensor_5>
    <Sensor_6>OFF</Sensor_6>
    <Sensor_7>OFF</Sensor_7>
    <Sensor_8>OFF</Sensor_8>
```

W&T

```
<Timer>OFF</Timer>
</Trigger>
<Min></Min>
<Max></Max>
<Interval></Interval>
<AlarmEnable>
  <Mail_enable>OFF</Mail_enable>
  <SNMP_Trap_enable>OFF</SNMP_Trap_enable>
</AlarmEnable>
<Mail8>
  <E-Mail-Addr></E-Mail-Addr>
  <Subject></Subject>
  <Mailtext>Actual temperature: &lt;Tl&gt; °C</Mailtext>
</Mail8>
<SNMP8>
  <Manager_IP></Manager_IP>
  <TrapText>&lt;Tl&gt;</TrapText>
</SNMP8>
</Alarm8>
</Alarm>
<Data_Logger>
  <Timebase>
    <_1_min>ON</_1_min>
    <_5_min>OFF</_5_min>
    <_15_min>OFF</_15_min>
    <_60_min>OFF</_60_min>
  </Timebase>
  <Select_Sensor>
    <Sensor_1>ON</Sensor_1>
    <Sensor_2>ON</Sensor_2>
    <Sensor_3>ON</Sensor_3>
    <Sensor_4>ON</Sensor_4>
    <Sensor_5>ON</Sensor_5>
    <Sensor_6>ON</Sensor_6>
    <Sensor_7>ON</Sensor_7>
    <Sensor_8>ON</Sensor_8>
  </Select_Sensor>
</Data_Logger>
<Protocol>
  <UDP>
    <Port>42279</Port>
```

W&T

```
</UDP>
</Protocol>
<Enable>
  <Enable>
    <Update_enable>OFF</Update_enable>
    <Mail_enable>ON</Mail_enable>
    <SNMP_enable>ON</SNMP_enable>
    <UDP_enable>OFF</UDP_enable>
    <GET_Single_Header_enable>ON</GET_Single_Header_enable>
    <Apply_Timezone>ON</Apply_Timezone>
    <Apply_Summertime>ON</Apply_Summertime>
    <Apply_TimeServer>OFF</Apply_TimeServer>
  </Enable>
  <Startup>
    <index.htm>ON</index.htm>
    <home.htm>OFF</home.htm>
    <user.htm>OFF</user.htm>
  </Startup>
</Enable>
</Device>
<Port1>
  <Name>Sensor 1</Name>
  <Text>Sensor description 1</Text>
</Port1>
<Port2>
  <Name>Sensor 2</Name>
  <Text>Sensor description 2</Text>
</Port2>
<Port3>
  <Name>Sensor 3</Name>
  <Text>Sensor description 3</Text>
</Port3>
<Port4>
  <Name>Sensor 4</Name>
  <Text>Sensor description 4</Text>
</Port4>
<Port5>
  <Name>Sensor 5</Name>
  <Text>Sensor description 5</Text>
</Port5>
<Port6>
```

W&T

```
<Name>Sensor 6</Name>
<Text>Sensor description 6</Text>
</Port6>
<Port7>
  <Name>Sensor 7</Name>
  <Text>Sensor description 7</Text>
</Port7>
<Port8>
  <Name>Sensor 8</Name>
  <Text>Sensor description 8</Text>
</Port8>
<Manufacturer>
  <Name>Wiesemann & Theis GmbH</Name>
  <Address>Wittener Strasse 312<br>
42279 Wuppertal<br>
Germany</Address>
  <Support_Hotline>+49-(0)202-2680-0</Support_Hotline>
  <Internet>www.wut.de</Internet>
  <DeviceTyp>Web-IO Thermometer, 10/100BT, 12-24V</DeviceTyp>
  <DeviceNo>#57604</DeviceNo>
  <Logo>logo.gif</Logo>
</Manufacturer>
</io-AN8.2>
```

W&T

7.5 Example for setting the „user.htm“

Create an HTML file which must begin with the expression

```
<user.htm> (or log.htm oder home.htm)
```

Next enter the HTML code.

You are able to choose from the following parameters for displaying on your page:

```
<w&t_tags=tx>
```

displays the current temperature. x indicates here the sensor number (1..8).

```
<w&t_tags=time>
```

inserts the current time.

```
<w&t_tags=steps>
```

inserts a list box for selecting the time steps for display.

```
<w&t_tags=ok_button>
```

adds an „OK“ button which sends the selected parameters to the unit.

```
<w&t_tags=session>
```

inserts an invisible session monitor so that the user is not logged out of the device when leaving the page. The expression is only needed if you want to design your own button. Then insert this expression between `<form action>` and `</form>`.

```
<w&t_tags=Sensor:x>
```

inserts the name of sensor ‚x‘ into the page and includes a link to the complete sensor description.

W&T

```
<w&t_tags=device_name>
```

inserts the assigned device name.

```
<w&t_tags=device_text>
```

inserts the freely configurable descriptive text for the device.

```
<w&t_tags=reload_button>
```

inserts a „Reload“ button which reloads the current page.

```
<w&t_tags=previous_button>
```

```
<w&t_tags=next_button>
```

inserts a button each for scrolling forward or back through the table.



The „Previous“-Button and the „Next“-Button only functions in connection with the „log.htm“ file.

```
<w&t_tags=logtable>
```

inserts a table with the current measured values. The function for navigating this table forward and backward („log.htm“ only, see above) is performed using the „Next“ and „Previous“ buttons. Only the current measure values can be displayed on both sides (user.htm and home.htm).

To specify the output format for the data, inset the following line into your document:

```
<form action="log.htm" method="POST" >
```

```
....
```

```
</form>
```

CSV output can be specified by using the expression

```
<form action="thermo.csv" method="POST" >
```

```
....
```

```
</form>.
```

W&T



Resetting to the factory defaults restores the original HTML pages.

Example user.htm:

```
<user.htm>
<html>
<head>
<title>Untitled Document</title>
<meta http-equiv="Content-Type" content="text/html; charset=iso-8859-1">
</head>

<body bgcolor="#FFFFFF" text="#000000">
<p>Web-IO Thermometer</p>
<p>Time: <w&t_tags=time></p>
<p><w&t_tags=sensor1>: <w&t_tags=t1> °C</p>
<p><w&t_tags=sensor2>: <w&t_tags=t2> °C</p>
<p><w&t_tags=sensor3>: <w&t_tags=t3> °C</p>
<p><w&t_tags=sensor4>: <w&t_tags=t4> °C</p>
<p>&nbsp;</p>

<form action="log.htm" method="POST">
  <p>Output data logger:</p>
  <p><w&t_tags=steps></p>
  <p><w&t_tags=ok_button></p>
</form>

<form action="thermo.csv" method="POST">
  <p>CSV output</p>
  <p><w&t_tags=steps></p>
  <p><w&t_tags=ok_button></p>
</form>

<form action="user.htm" method="GET">
  <p><w&t_tags=reload_button></p>
</form>
</body>
</html>
```

W&T

This page is displayed by the Web-IO Thermometer in the Web browser as follows:

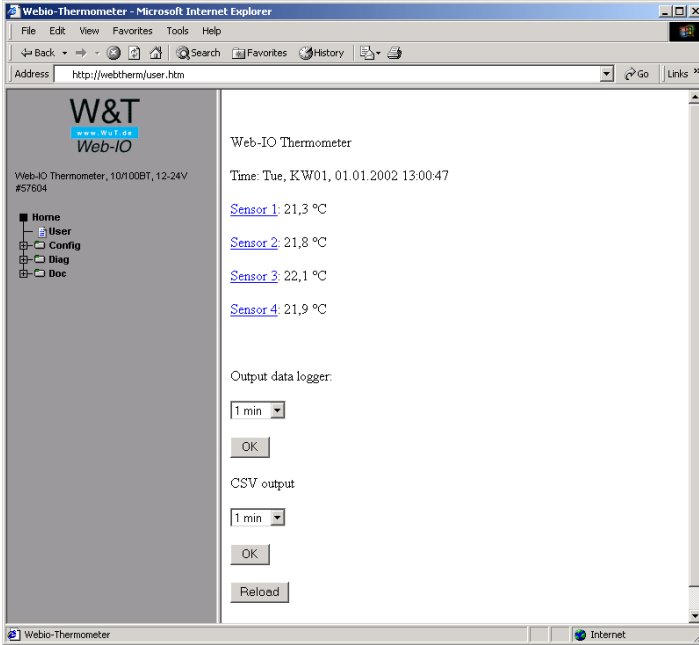

W&T

Example log.htm:

```
<log.htm>
<html>
<head>
<title>Untitled Document</title>
<meta http-equiv="Content-Type" content="text/html; charset=iso-8859-1">
</head>

<body bgcolor="#FFFFFF" text="#000000">

<form action="log.htm" method="POST">
  <w&t_tags=previous_button>
</form>

<w&t_tags=logtable>

<form action="log.htm" method="POST">
  <w&t_tags=next_button>
</form>
</body>
</html>
```

W&T

This page is displayed by the Web-IO Thermometer in the Web browser as follows:

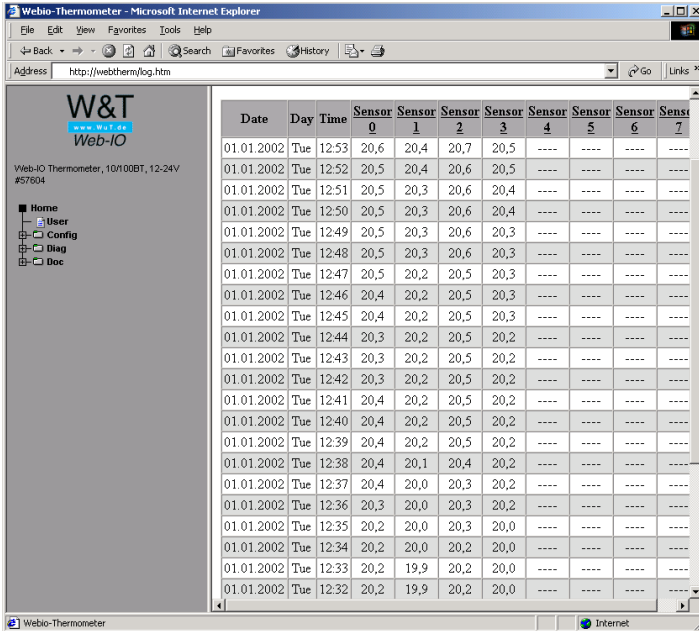

7.6 Technical specifications

Article number	57601	57603	57604
	Web-IO 1x Thermometer	Web-IO 2x Thermometer	Web-IO 8x Thermometer
Temperature sensor	NTC and PT100 connection		
Network	10/100BaseT autosensing		
Supply voltage	12-24V AC/DC, screw terminal block		
Sensing unit			
Temperature sensor	NTC 10k, PT100 connection, 2-, 3- or 4-wire		
Range	-45°C ... 75°C		
Resolution	1/10 °C		
Measuring error	+/- 0,3°C, +/- 5% (NTC) +/- 0,3°C, +/- 2% (PT100)		
Memory frequency	1, 5, 15, 60 min		
Memory depth (64kB)	min. 6 weeks, max. 390 weeks	min. 22 days, max. 195 weeks	min. 5 days, max. 48 weeks
Other Data			
Galvanic isolation	Measuring inputs to network: min. 500V		
Mail function	Mail for alarm or as reporting function		
Supply voltage	DC 12V (-5%) - 34V (+5%) AC 9V eff (-5%) - 24V eff (+5%)		
Current Draw	AVG:170mA @ 12VDC, 80mA @ 24VDC		
Emergency access	Serial port RS232, 9600 baud, 8 data bits, 1 stop bit, no parity, no handshake		
Housing	Plastic compact housing 105 x 75 x 22 mm (l x w x h)	Plastic compact housing, 106.8 x 87.8 x 62.6 mm (l x w x h)	
Weight	ca. 200g		
Ambient temperature storage	-40 ... +70°C		
Ambient temperature operating	non cascaded: 0 ... 60°C cascaded: 0... 50°C	0 ... 60°C	