

Manual

Com-Server++ Com-Server PoE 3x Isolated Com-Server 20mA

Release 2.13, October 2019
Typ 58665, 58662, 58664
Firmware 1.49 or higher
SN 02511425 or higher



© 10/2019 by Wiesemann und Theis GmbH
Microsoft, MS-DOS, Windows, Winsock and Visual Basic
are registered trademarks of the Microsoft Corporation.

ST is a registered trademark of AT&T Lightguide Cable Connectors.

Subject to error and alteration:

Since it is possible that we make mistakes, you mustn't use any of our statements without verification. Please, inform us of any error or misunderstanding you come about, so we can identify and eliminate it as soon as possible.

Carry out your work on or with W&T products only to the extent that they are described here and after you have completely read and understood the manual or guide. We are not liable for unauthorized repairs or tampering. When in doubt, check first with us or with your dealer.

Introduction

The *Com-Server++ 58665*, *Com-Server PoE 3x Isolated 58662* and *Com-Server 20mA 58664* represent a uniform platform for linking serial interfaces such as RS232, RS422/485 and 20mA/TTY to TCP/IP networks. The standard modes for transparent tunneling of serial data (e.g. through virtual COM ports) are implemented. The Com-Server++ includes additional protocols and modes (e.g. UDP, TCP client, FTP client/server, etc.) as well as expanded functions for structuring the data interchange.

In addition to all the standard applications implemented in the firmware, this reference manual also describes the integration possibilities for your own applications.

Inhalt

1 Quickstart	9
1.1 Flow chart – Network installation using WuTility.....	10
1.2 Overview of configuration menu	11
1.3 Factory defaults settings	12
2 Assigning the IP parameters	13
2.1 Configuring network parameters with WuTility.....	14
2.2 Assigning the IP using DHCP protocol.....	17
2.2.1 Manual activation of DHCP.....	17
2.2.2 System name	18
2.2.3 Lease time	18
2.2.4 Reserved IP addresses.....	19
2.2.5 Dynamic IP addresses	19
2.3 Assigning the IP using the ARP command	20
2.4 Assigning the IP using the serial port.....	23
2.5 IP Address Conflict Detect.....	25
3 Supply voltage	27
3.1 Supply voltage 58665, 58664.....	28
4 Network interface	31
4.1 Ethernet interface.....	32
5 The serial ports	35
5.1 Serial combi-port RS232/422/485	36
5.1.1 Opening the Com-Server.....	36
5.1.2 Mode selection	36
5.2 RS232 mode (factory default).....	37
5.3 RS422/485 mode.....	38
5.4 20mA/TTY interface	41
6 LED displays	43
6.1 LED displays	44
7 Configuration access to the Com-Server	47
7.1 Configuration menu structure.....	48
7.2 Configuration via Telnet.....	50
7.2.1 Navigation within the Telnet menu.....	50
7.3 Configuration via Browser - Web Based Management.....	52
7.3.1 Activating „WBM via HTTP“	52
7.3.2 Activating „WBM via HTTPS“.....	53
7.3.3 Starting and navigating the WBM.....	54
7.3.4 Certificate management.....	56

8 The basis configuration of the Com-Server	59
8.1 Save your settings.....	60
8.2 Menu: INFO System.....	61
8.3 Menu: SETUP System.....	62
8.3.1 Menu: SETUP System → Setup TCP/IP.....	62
8.3.2 Menu: SETUP System → System Password	66
8.3.3 Menu: SETUP System → System Name.....	67
8.3.4 Menu: SETUP System → Logfile	67
8.3.5 Menu: SETUP System → Flash Update.....	69
8.3.6 Menu: SETUP System → Factory Defaults	69
8.3.7 Menu: SETUP System → Reset	69
8.3.8 Menü: SETUP System → Link Speed.....	69
8.4 Menu ... → TCP/IP Mode → System Options	71
9 Configuration of the serial port	73
9.1 The serial parameters (Menu: UART Setup).....	74
9.1.1 Baud rate, Data bits, Stop bits, Parity	74
9.1.2 The handshake modes	75
9.1.3 Receive Buffer (InQueue)	79
9.1.4 FIFO Send/Rec (only Com-Server PoE 3x Isolated).....	80
9.2 TCP-/UDP port numbers (Menu: TCP/IP Mode).....	81
10 Packetizing serial datagrams.....	83
10.1 Packet Options.....	84
10.1.1 Startsequence/Endsequence	85
10.1.2 Startsequence + Lengthfield.....	88
10.1.3 Interpacket Delay.....	90
10.1.4 Fixed Packet Length.....	91
11 Mode TCP-Server	93
11.1 The Com-Server as TCP server.....	94
11.1.1 Configuration of the local port number	95
11.1.2 Optional settings	95
12 Mode TCP Client.....	99
12.1 The Com-Server as TCP client.....	100
12.1.1 TCP client mode with fixed destination system	101
12.1.2 TCP client mode with serial addressing	104
12.1.3 Optional settings	106
12.1.4 Deactivating TCP client mode.....	109
13 Data transfer per UDP.....	113
13.1 Der Com-Server als UDP-Peer	114
13.1.1 Setting the local UDP port number	115
13.1.2 UDP clientmode with fixed destination system	116
13.1.3 UDP client mode serial addressing	117
13.1.4 Optional settings	119
13.1.5 Deactivating UDP mode.....	120

W&T

14 UDP Bus Mode	121
14.1 Function of UDP Bus Mode	122
14.1.3 Optional settings	124
14.1.4 Deactivating UDP mode.....	125
15 The Windows COM port redirector	127
15.1 Overview.....	128
15.2 Download & installation of the W&T COM redirector.....	130
15.2.1 Installation of the W&T COM port redirector.....	130
15.2.2 Uninstalling the W&T COM Port Redirector	131
15.3 Set up virtual COM ports	132
15.3.1 Optional settings on the Com-Server.....	132
16 Box-to-Box mode	135
16.1 Box-to-Box application	136
16.1.1 Configuring Box-to-Box mode	137
16.1.2 Optional settings	138
16.1.3 Deactivating Box to Box Mode.....	140
17 Mode FTP-Server	143
17.1 The Com-Server as FTP server	144
17.1.1 Activating FTP-Server mode.....	144
17.1.2 Supported FTP commands and functions	145
17.1.3 Optional settings	146
18 Mode FTP-Client	147
18.1 The Com-Server as FTP client	148
18.1.1 Configuring the destination address and port no.	149
18.1.3 FTP client with serial protocol	152
18.1.4 Closing the FTP connection.....	154
18.1.5 Deactivating FTP client mode	155
18.1.6 Application examples	156
19 Mode Telnet Server	159
19.1 The Com-Server as Telnet server	160
19.1.1 Activating Telnet-Server mode	160
19.1.2 Optional Settings	161
20 Mode Telnet Client	163
20.1 The Com-Server as Telnet client.....	164
20.1.1 Destination address and port number.....	164
20.1.2 Optional settings	166
20.1.3 Deactivating Telnet client mode.....	167
21 Mode SLIP-Router	169
21.1 SLIP mode.....	170

W&T

21.1.1	Configuring the SLIP mode.....	171
21.1.2	Optional settings	173
21.1.3	Deactivating SLIP router mode	173
21.1.4	Application example	174
21.1.5	Configuring the Com-Server via SLIP	175
22	OPC data transfer	177
22.1	Overview.....	178
22.2	Download and installation of the W&T OPC server.....	179
22.2.1	Installation of the W&T OPC server.....	179
22.2.2	Deinstallation of the OPC server.....	180
22.3	Configuration of the OPC server.....	181
22.3.1	Optional settings on the Com-Server.....	181
22.3.2	Incorporating the Com-Server into the OPC Server...	183
22.3.3	Structuring the serial data.....	184
22.4	Serial OPC variables	185
23	Mode InQueueCopy	187
23.1	InQueue Copy.....	188
23.1.2	Configuring InQueueCopy.....	189
24	Status and error messages	191
24.1	Menu Setup Port x → Port State	192
25	Expanded services of the Com-Server	195
25.1	The control port.....	196
25.2	Reset Com-Server port	203
25.3	Com-Server reset	204
25.4	Up-/downloading configuration data.....	205
25.5	Inventory taking per UDP/8513.....	207
25.6	SNMP management.....	209
26	Firmware-Update of the Com-Server.....	211
26.1	Where do I get the current firmware?	212
26.2	Network firmware update under Windows	213
26.3	Incomplete and interrupted updates	216
Appendix.....	217
A1	Ports and services.....	218
A2	Network security.....	220
A3	Serial assignment of the IP address under Windows	224
A4	WuTility - Inventory and management tool	227
A5	Hardware-Reset to factory defaults	228
A6	Technical data and formfactor 58665	229
A7	Technical data and formfactor 58662	230
A8	Technical data and formfactor 58664	231
Index	232

W&T

Legal information and safety

Legal notices

Warning concept

This manual contains notices that must be observed for your personal safety as well as to prevent damage to equipment. The notices are emphasized using a warning sign. Depending on the hazard level the warning notices are shown in decreasing severity as follows.

DANGER

Indicates a hazard which results in death or severe injury if no appropriate preventive actions are taken.

WARNING

Indicates a hazard which results in death or severe injury if no appropriate preventive actions are taken.

CAUTION

Indicates a hazard that can result in slight injury if no appropriate preventive actions are taken.

NOTE

Indicates a hazard which can result in equipment damage if no appropriate preventive actions are taken.

If more than one hazard level pertains, the highest level of warning is always used. If the warning sign is used in a warning notice to warn of personal injury, the same warning notice may have an additional warning of equipment damage appended.

Qualified personnel

The product described in this manual may be installed and placed in operation only by personnel who are qualified for the respective task.

The documentation associated with the respective task

W&T

must be followed, especially the safety and warning notices contained therein.



Qualified personnel are defined as those who are qualified by their training and experience to recognize risks when handling the described products and to avoid possible hazards.

Disposal

Electronic equipment may not be disposed of with normal waste, but rather must be brought to a proper electrical scrap processing facility.

The complete declarations of conformity for the devices described in the instructions can be found on the respective Internet data sheet page on the W&T homepage at <http://www.wut.de>.

Symbols on the product

Symbol	Explanation
	CE mark The product conforms to the requirements of the relevant EU Directives.
	WEEE mark The product may not be disposed of with normal waste, but rather in accordance with local disposal regulations for electrical scrap.

Safety notices

General notices

This manual is intended for the installer of the Com-Servers described in the manual and must be read and understood before starting work. The devices are to be installed and put in operation only by qualified personnel.

Intended use

DANGER

The *Com-Server++ 58665*, *Com-Server PoE 3x Isolated 58662* and *Com-Server 20mA 58664* represent a uniform platform for linking serial interfaces such as RS232, RS422/485 and 20mA/TTY to TCP/IP networks.

Any other use or modification of the described devices is not intended.

Electrical safety

WARNING

Before beginning any kind of work on the Com-Server you must completely disconnect it from power. Be sure that the device cannot be inadvertently turned on again!

Com-Servers may be used only in enclosed and dry rooms.

The device should not be subjected to high ambient temperatures or direct sunlight, and it should be kept away from heat sources. Please observe the limits with respect to maximum ambient temperature.

Ventilation openings must be clear of any obstacles. A distance of 10-15 cm between the Web-IO and nearby heat sources must be maintained.

W&T

Input voltage and output currents must not exceed the rated values in the specification.

When installing be sure that no stray wires stick out through the ventilation slit of the Com-Server into the housing. Ensure that no individual wires stand off from leads, that the lead is fully contained in the clamp and that the screws are tightly fastened. Fully tighten screws on unused terminals.

The power supply used for the Com-Server must absolutely ensure safe isolation of the low-voltage side from the supply mains according to EN60950-1 and must have "LPS" designation.

EMC

▲NOTE

Only shielded network cables may be used for connecting the Com-Server to the network.

In this case the Com-Server meet the noise immunity limits for industrial applications and the stricter emissions limits for households and small businesses. Therefore there are no EMC-related limitations with respect to the usability of the devices in such environments.

The complete Declarations of Conformity for the devices described in the manual can be found on the corresponding Internet page at the W&T homepage: <http://www.wut.de>.

1 Quickstart

Already experienced users of Com-Servers will find on the two following pages a flow chart with the essential steps for start-up as well as a complete overview of the configuration menu. Detailed information can be found then in the following sections.

1.1 Flow chart - Network installation using WuTility

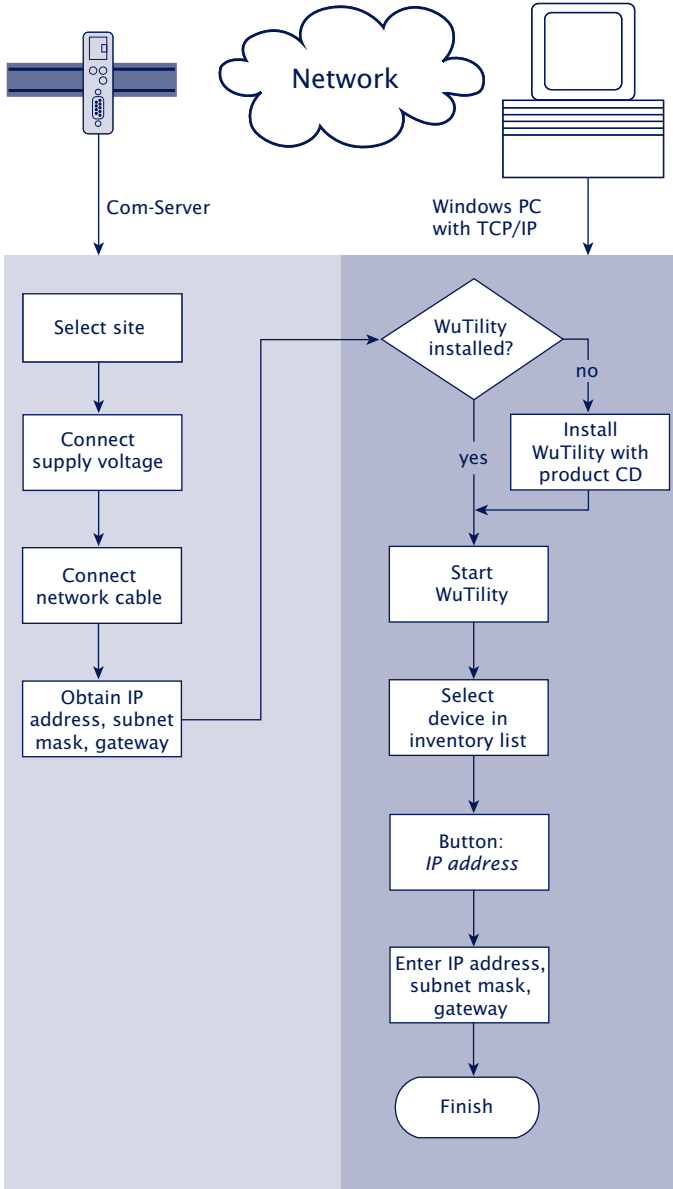

1.2 Overview of configuration menu

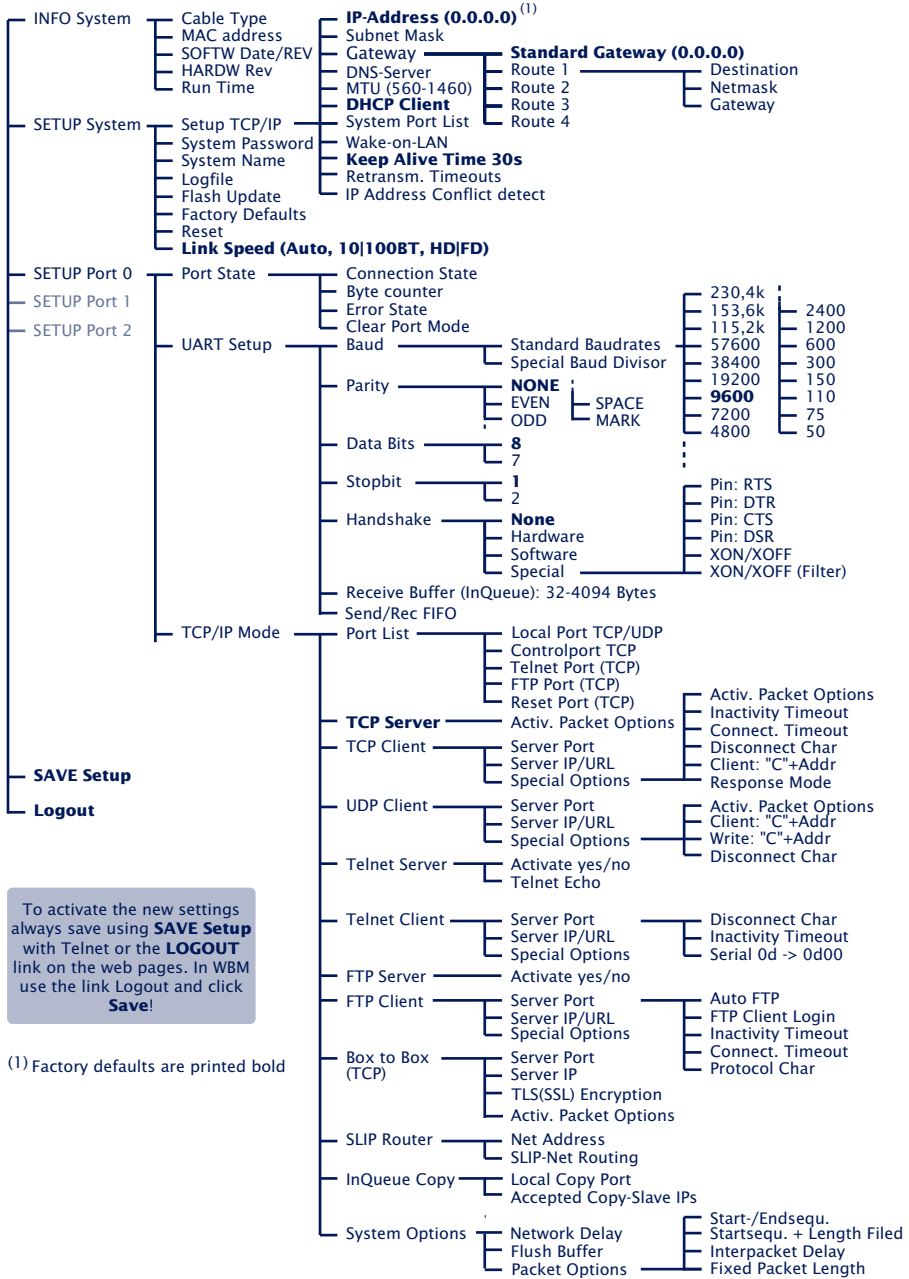

To activate the new settings always save using **SAVE Setup** with Telnet or the **LOGOUT** link on the web pages. In WBM use the link Logout and click **Save!**

(1) Factory defaults are printed bold

1.3 Factory defaults settings

The list contains an overview of the most important settings. For many applications, such as the W&T COM Port Redirector, no additional configurations need to be made besides assigning the network base parameters. Detailed information on the respective parameters can be found in later sections of this manual.

Network settings

Hardware connection:	Auto negotiating
IP address:	0.0.0.0
Gateway address:	0.0.0.0
Subnet mask:	255.0.0.0
DHCP:	Active

 *To prevent unintended address assignments or changes, we recommend deactivating the DHCP protocol if it is not expressly used in the respective network environment.*

Serial settings

Hardware connection:	RS232
Baud rate:	9600
Data bits:	8
Parity:	NO
Stop bits:	1
Handshake:	None
Fifo:	OFF

Configuration access

Per Telnet using TCP port 1111

Network applications / Operating mode

(suitable for use with W&T COM redirector)

TCP server ports, port no. A-C:	8000, 8100, 8200
Control port TCP, port no. A-C:	9094, 9194, 9294

2 Assigning the IP parameters

The Com-Server is factory set to IP address 0.0.0.0. Before you can make the entry in the Com-Server, you need to specify an IP address that is valid for your network. Your system administrator will provide you with this. The IP address must be unique within the network!

- IP configuration using management tool *WuTility*
- IP configuration using the ARP command
- Assigning IP address, subnet mask and gateway address through the serial port
- IP configuration using DHCP protokoll
- IP Address Conflict Detect

2.1 Configuring network parameters with WuTility

WuTility is the central inventorying and management tool for all W&T network devices. In addition to convenient assigning of the IP parameters, *WuTility* also provides quick access to device configurations, the ability to perform firmware updates, managing configuration profiles, etc.

Current versions of *WuTility* are always available on our website at <http://www.wut.de>. From there you can navigate using the menu tree on the left side.

Products & Downloads → *Com-Server* → *Software-Tools*

You install *WuTility* by double-clicking on the file *wutility_***.exe*. Start *WuTility* using

Start → *All Programs* → *W&T Software Toolkit* → *WuTility*

2.2.1 Applications and prerequisites

IP assignment using *WuTility* works regardless of the current network parameters of the Com-Server and the computer used. This means that even if the Com-Server does not have IP parameters consistent with the respective network, *WuTility* can be used to overwrite them. Likewise, *WuTility* can be used to assign any values not consistent with the network the PC is located in.

- The PC and Com-Server must be located in the same physical network. This means you cannot assign values through a router.
- Any firewalls and network security packages installed on the PC must allow communication between *WuTility* and the Com-Server based on UDP broadcasts. If necessary these must be correspondingly configured or temporarily turned off.
- If the Com-Server does not have its factory default settings and there is a system password assigned, this must be known in order to make changes using *WuTility*.

Step 1: Start the assignment dialog

WuTility automatically searches the local network for connected W&T network devices and creates an inventory list. This search process can be repeated manually as often as desired by clicking on the *Scan* button:



Within the inventory list you can identify the desired Com-Server based on its MAC address. For initial installations its IP address is 0.0.0.0.

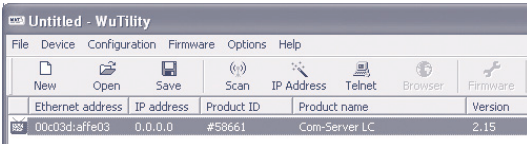

Select the Com-Server and click on the *IP address* button:

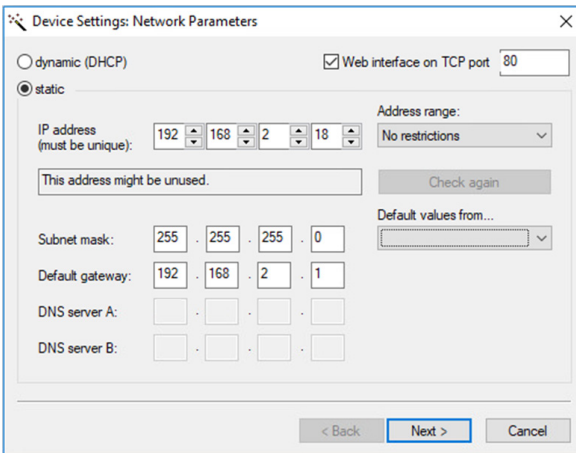

Step 2: Assign the IP parameters

The *Static* option allows you to assign fixed basic parameters while simultaneously disabling the *DHCP* protocol in the Com-Server. Enter the desired values for IP address, subnet mask and gateway address in the corresponding entry fields. The *DHCP* option enables DHCP protocol in the Com-Server, and operation with a static IP address is no longer possible (see *IP Assignment using DHCP Protocol* for detailed information)

If the remaining configuration of the Com-Server is done using a Web browser, activate the option Web-Based-Management (WBM). If you are not using the standard HTTP port 80, change the port number to the desired value.

 *At this point, WBM can only be activated via HTTP (unencrypted). If access is to be encrypted using HTTPS, this change must be made subsequently using the standard WBM access or using Telnet.*

Clicking on the *Next* button assigns the network parameters to the Com-Server. After acknowledging the resulting message, all the columns in the *WuTility* device list are filled in with information.

If necessary, the remaining configuration of the Com-Server is done using Telnet or Web-Based-Management. Click on the Telnet or Browser button.

Telnet:  Browser: 

Additional information can be found in the section *Configuration Accesses for the Com-Server*.

2.2 Assigning the IP using DHCP protocol

With the factory settings, the DHCP protocol is activated in the Com-Server, so that in DHCP environments it is sufficient to connect the Com-Server to the network. The following parameters are assigned using DHCP:

- IP address
- Subnet mask
- Gateway address

2.2.1 Manual activation of DHCP

To prevent unintended address assignments or address changes, DHCP protocol is automatically deactivated when using all other methods for assigning the IP parameters. The following methods are then available for later activation of DHCP.

- **Management-Tool WuTility**

Select the desired Com-Server from the device list and click on the IP Address button. In the following dialog check the option DHCP and then click on Next.

- **Telnet-/WBM configuration**

In the menu branch *SETUP System* → *Setup TCP/IP* → *DHCP Client* you can activate DHCP protocol. For detailed information, see the section Menu: SETUP System.



A set static IP address is deleted after DHCP is activated and the associated automatic reset. The Com-Server automatically sets this to 0.0.0.0 and starts sending DHCP requests.

2.2.2 System name

To support any automatic updating of the DNS system by the DHCP server, the Com-Server identifies itself within the DHCP protocol with its system name. The factory default setting for this is *COMSERVER-* followed by the last three places of the Ethernet address. For example the factory set system name of a Com-Server with the Ethernet address 00:c0:3d:01:02:03 is *COMSERVER-010203*. The system name of the Com-Server can be changed in the configuration. For additional information refer to the section *Menu: SETUP System → System Name*.

2.2.3 Lease time

The lease time determined and transmitted by the DHCP server specifies the Time-To-Live of the assigned IP address. After half the lease time has expired, the Com-Server attempts to extend the time for the assigned DHCP server and update the address. If this is not possible by the time the lease time expires, for example because the DHCP server can no longer be reached, the Com-Server deletes the IP address and starts a new cyclical search for alternate DHCP servers for the purpose of assigning a new IP address.

Because of the absent clock, the lease time associated with the current IP address is no longer available after a reset. After the restart therefore a corresponding update request is issued with the original DHCP server. If the latter is not resolvable at this point in time, the Com-Server deletes the IP address and starts a new cyclical search for alternate DHCP servers.

If DHCP is activated, the remaining lease time together with the current IP address is displayed in the menu item *SETUP System → Setup TCP/IP → IP-Address* using the format hh:mm:ss.

2.2.4 Reserved IP addresses

If the Com-Server is used as a TCP server or UDP peer, it provides services which other clients in the network can also make use of as needed. To open a connection, they of course need the current IP address for the Com-Server, so that in such situations it makes sense to reserve a particular IP address for the Com-Server on the DHCP server. This is generally done by linking the IP address to the unique Ethernet address of the Com-Server, which can be found on the sticker attached to the housing.

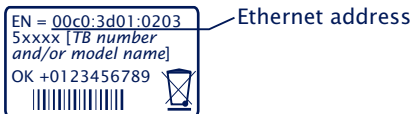

2.4.5 Dynamic IP addresses

Fully dynamic address assignment, whereby the Com-Server gets a different IP address every time it is restarted or after the lease time has expired, only makes sense in network environments with automatic cross-connection between the DHCP and DNS services. This means when a new IP address is assigned to the Com-Server, the DHCP server then automatically updates the DNS system as well. The new address is associated with the respective domain name. If in doubt, consult your system administrator for detailed information about your network environment.

2.3 Assigning the IP using the ARP command

Requirements

This method can only be used if the Com-Server does not already have an IP address, i.e. the entry is 0.0.0.0. To change an IP address, use one of the other methods described in this section or use the configuration menu over Telnet. If the Com-Server has any other value, this access is disabled.

When the factory setting is in effect as well as after a manual changeover from static to DHCP, the method for assigning the IP described in this section functions only after a delay of approx. 2 minutes after a reset or after power-up.

This method does *not* work across networks, e.g. through routers. This means the PC and Com-Server used for assigning must be connected to the same physical network segment. Only IP addresses whose Net-ID is identical to that of the assigning computer can be assigned.

 *To avoid unintended changes to the IP address, the DHCP client of the Com-Server is automatically deactivated when configuring using a static ARP entry.*

Step 1

Read off the Ethernet address of the Com-Server from the sticker on the side of the housing.



Insert a static entry into the ARP table of the computer using the following command line:

```
arp -s [IP address] [Ethernet address]
```



Older Windows systems only accept a static entry if there is a dynamic one already present. Here you should first ping another network station.

E.g. under Windows:

```
arp -s 172.16.231.10 00-C0-3D-00-12-FF
```

E.g. under UNIX/Linux:

```
arp -s 172.16.231.10 00:C0:3D:00:12:FF
```

 *The IP addresses must be without leading zeros in all Windows environments. Otherwise the entry is incorrectly interpreted by the system and an incorrect IP address is assigned to the Com-Server. In Windows Vista and newer the prompt cmd.exe necessary for invoking the ARP command must be started using Administrator rights.*

Step 2

Use the following command line to *ping* the Com-Server with the desired IP address:

```
ping 10.10.21.12
```

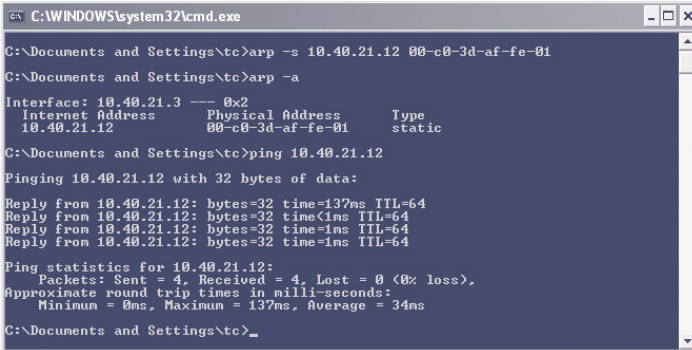

```

C:\WINDOWS\system32\cmd.exe
C:\Documents and Settings\tc>arp -s 10.40.21.12 00-c0-3d-af-fe-01
C:\Documents and Settings\tc>arp -a
Interface: 10.40.21.3 --- 0x2
   Internet Address      Physical Address      Type
   10.40.21.12           00-c0-3d-af-fe-01   static
C:\Documents and Settings\tc>ping 10.40.21.12
Pinging 10.40.21.12 with 32 bytes of data:
Reply from 10.40.21.12: bytes=32 time=137ms TTL=64
Reply from 10.40.21.12: bytes=32 time<1ms TTL=64
Reply from 10.40.21.12: bytes=32 time=1ms TTL=64
Reply from 10.40.21.12: bytes=32 time=1ms TTL=64
Ping statistics for 10.40.21.12:
    Packets: Sent = 4, Received = 4, Lost = 0 (0% loss),
    Approximate round trip times in milli-seconds:
        Minimum = 0ms, Maximum = 137ms, Average = 34ms
C:\Documents and Settings\tc>_

```

The Com-Server takes the IP address of the first network packet sent to it as its own and saves it in non-volatile memory. The ping requests of the PC are then replied.

It is not possible to configure the subnet mask and gateway

address using a static ARP entry. These need to be set in a separate Telnet configuration session (see section *Basic Configuration of the Com-Server*).

2.4 Assigning the IP using the serial port

After a Com-Server reset a time window of around 1-2 seconds is available on port A, during which you can assign a new IP address, subnet mask and gateway address by entering at least 3 „x“.

In contrast to other methods described above, this serial method functions regardless of whether the Com-Server already has an IP address or not. The procedure can be repeated as often as desired. The appendix contains the detailed procedure under Windows.

Preparations/requirements

First connect the serial port A of the Com-Server to a computer. For a standard PC or laptop, you will need a *crossed* RS232 cable (=Null modem cable, see *RS232 mode*).

 *The model 58664 Com-Server 20mA features a TTY interface and cannot therefore be connected directly to the standard COM port (RS232) of a PC.*

Any serial terminal program can be used for assigning. The following transmission parameters must be set regardless of any other settings in the Com-Server:

9600 baud, no parity, 8 data bits, 1 Stop bit, no Handshake

Start the serial configuration mode

Reset the Com-Server by interrupting the power. While the Com-Server is starting up, use the terminal program to send the letter x at least three times. The COM-Server will then return the prompt *IPno.+<Enter>:*.

Assigning the IP settings

Use the usual format (xxx.xxx.xxx.xxx) to enter the IP address, and end the entry by pressing <Enter>. If the entry was accepted, the acknowledgement is the assigned IP address. Otherwise you will get a *FAIL* message followed by the last current IP address.

Together with the IP address, the subnet mask and gateway address can also be assigned serially. The entry is separated by commas and follows the IP address. Entering as shown in the following example will assign IP address 172.17.231.99, subnet mask 255.255.255.0 and gateway 172.17.231.52 to the Com-Server

Exampel: Assigning the IP address:

```
IP no.+<ENTER>:          <- Com-Server
172.17.231.99            -> Com-Server
```

Example: Assigning IP address, Subnet mask and gateway

```
IP no.+<ENTER>:          <- Com-Server
172.17.231.99, 255.255.255.0,172.17.231.1  -> Com-Server
```

Option: Activating Web Based Management (WBM)

To further configure the Com-Server you can use either Telnet protocol or an Internet browser, although only Telnet is an option in the Com-Server as shipped from the factory. You can activate Web Based Management as part of the serial IP assignment. To do this, enter *+w[Portno.]* directly after the IP address or address string. Here *Portno.* is the desired TCP port in decimal format.

 *At this point, WBM can only be activated via HTTP (unencrypted). If access is to be encrypted using HTTPS, this change must be made subsequently using the standard WBM access or using Telnet.*

Exampel: Assigning IP address, subnet mask, gateway and activating WBM on port 8800.

```
xxx...                  -> Com-Server
IP no.+<ENTER>:          <- Com-Server
172.17.231.99,255.255.0.0,172.17.231.1+w8800  -> Com-Server
172.17.231.99,255.255.0.0,172.17.231.1+w8800  <- Com-Server
```

2.5 IP Address Conflict Detect

Firmware version 1.31 and higher enables the Com-Server++ to detect and display an IP address conflict. This function is deactivated by default and can be activated in the following menu branch:

```
SETUP System
  ↳ ...
    Setup TCP/IP
      ↳ ...
        IP Address Conflict Detect
```

When the Com-Server is restarted there is an active check for any address conflicts. During normal running the monitoring is passive. Details on this functionality can be found in RFC5227, IPv4 Address Conflict Detection.

Indication of an address conflict

The Com-Server++ indicates a detected address conflict by rapid flashing (approx. 3x/s) of the Error LED. In addition a message including the competing MAC address is generated in the Error State (*Setup Port x → Port State → Error State*).

When using a static IP address the conflict is only indicated. The Com-Server continues to use this IP address. In a DHCP environment the Com-Server informs the responsible DHCP server, resets the IP address and waits for assignment of a corrected IP address.

i *IP address conflicts generally lead to communication problems which are difficult to diagnose. Please therefore inform the responsible administrator in such cases.*

3 Supply voltage

- Com-Server++
- Com-Server PoE 3x Isolated
- Com-Server 20mA

3.1 Supply voltage 58665, 58664

The models 58665, 58664 and 58662 can also be operated either using PoE *or* from an external power supply. Connecting an external supply voltage and a PoE infrastructure at the same time is not permitted.

The current draw can be found in the technical appendix.

3.1.1 Power over Ethernet

In PoE environments (Power-over-Ethernet, IEEE802.3af) power is provided by the network infrastructure. The Com-Server supports both phantom power using data pairs 1/2 and 3/6 as well as power feed using the unused wire pairs 4/5 and 7/8.

The models 58665, 58664 and 58662 are devices in PoE Power Class 1 (power consumption 0.44 to 3.84W).

3.1.2 External supply

As an alternative to PoE power supply the Com-Servers can also be powered by an external power supply connected to the screw terminals on the underside of the housing. AC or DC power may be used, whereby the following limit values must be observed:

- AC: 18Vrms (- 10%) - 30Vrms (+10%)
- DC: 12V (-10%) - 48V (+10%)
(before SN 2283238 24V (-10%) - 48V (+10%))

When powering with DC voltage polarity must be observed:

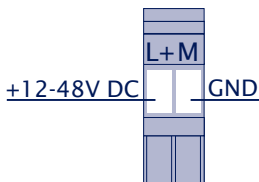

 WARNING

Only potential-free power supplies may be used for powering the models 58665, 58664 and 58662. Their reference ground for the output voltage must not have a direct connection to the PE conductor.

4 Network interface

- Ethernet interface
- 10/100BaseT autonegotiating
- Power-over-Ethernet

4.1 Ethernet interface

The Com-Servers incorporates an IEEE 802.3-compatible network interface.

4.1.1 Link status

The Link status is indicated on the two LEDs built into the RJ45 jack.

- **Link/Activity (green)**
ON indicates a valid link to a hub or switch port. The LED flashes when there is data traffic.
- **Speed (yellow)**
ON indicates a 100MBit/s-link (100BaseT). OFF indicates 10MBit/s (10BaseT)

4.1.2 10/100BaseT on RJ45

The Com-Servers have a network interface on a shielded RJ45 connector. The pin assignments shown below correspond to an Auto-MDI-X interface, so that the connection to the hub or switch is made using a max. 100m long shielded patch cable.

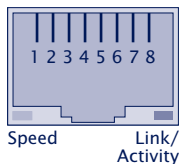

The network connection is galvanically isolated with respect to the supply voltage as well as the serial interface(s) for at least $1,5kV_{rms}$.

Auto Negotiation: 10/100BaseT, Full/Half Duplex

The Com-Servers are factory set to operate in Auto-Negotiation mode on the network side. The data transmission speed and duplex are automatically negotiated with the connected switch/hub and set accordingly.

In addition to the Auto-Negotiation mode, both the Com-Servers as well as many switches can be configured for fixed

transmission parameters with respect to speed and duplex. To prevent communications problems (duplex mismatch), only the following two combinations are permissible:

- *Both* parties (switch and Com-Server) are operated in Auto-Negotiation mode.
- *Both* parties are configured for the same (fixed) transmission speeds and duplex mode.

Use menu sequence *Setup System* → *Link Speed* to switch between Auto-Negotiation and fixed transmission speeds/duplex mode.

Power-over-Ethernet - PoE

The Com-Servers can obtain power as defined in IEEE802.3af/Power-over-Ethernet. Either the data pairs or the unused wire pairs in 10/100BaseT may be used (see also the section *Supply Voltage*).

5 The serial ports

- Serial combi-port RS232/RS422/RS485
- Mode selection
- 20mA/TTY port

5.1 Serial combi-port RS232/422/485

The *Com-Server++ 58665* and *Com-Server PoE 3x Isolated* come standard with an RS232/422/485 combi-ports whose modes are described below.

All external signal lines use ESD-immune interface components to provide protection against static discharges of up to 15kV per IEC 801-2, Level 4.

5.1.1 Opening the Com-Server

To open the Com-Server, plug the DB9 connector into the serial port. After tightening the two mounting screws, pull on the DB9 plug to remove the circuit board from the housing..

5.1.2 Mode selection

Switching between the modes is accomplished using the internal DIL switches located on the respective interface module. The following table shows an overview of all modes:

Mode	SW1	SW2	SW3	SW4	SW5	SW6	SW7	SW8
RS232 (*)	OFF	OFF	OFF	OFF	OFF	OFF	OFF	ON
RS422, RS485 4-wire-bus-master	OFF	OFF	OFF	OFF	ON	Term.	OFF	OFF
RS485 4-wire automatic control	OFF	ON	OFF	OFF	ON	Term.	OFF	OFF
RS485 2-wire automatic control	ON	ON	OFF	OFF	OFF	Term.	OFF	OFF

(*) Factory default

5.2 RS232 mode (factory default)

The pin configuration of the RS232 port is identical to that of a PC, which allows you to use standard cables.

DIP switch setting RS232

Mode	SW1	SW2	SW3	SW4	SW5	SW6	SW7	SW8
RS232	OFF	OFF	OFF	OFF	OFF	OFF	OFF	ON

NOTE

The terminating DIL switches SW6 and SW7 must never be in the ON position when using the module in RS232 mode. This will result in a significant increase in the current draw and may cause the RS232 driver to fail.

Pin assignment and function RS232, D9 male

Pin	Direction	Signal	Description	Default Function (*)
1	IN	DCD	Data Carrier Detect	Ignored
2	IN	RxD	Receive Data	Data in
3	OUT	TxD	Transmit Data	Data out
4	OUT	DTR	Data Terminal Ready	12V for existing TCP connection to a client or server
5	---	GND	Signal Ground	---
6	IN	DSR	Data Set Ready	Ignored
7	OUT	RTS	Ready To Send	Handshake output +12V = ready to receive data -12V = not ready to receive data
8	IN	CTS	Clear To Send	Data output only if +3...12V
9	IN	RI	Ring Indicator	Ignored

(*) Applies only to the hardware handshake setting

5.3 RS422/485 mode

As opposed to RS232, an RS422 interface allows transmission distances of up to 1000 meters. The RS485 mode allows you to integrate corresponding 2- or 4-wire bus systems into a TCP/IP network with the help of the Com-Server.

NOTE

Especially when using longer cable lengths in industrial environments, potential differences need to be taken into consideration. To prevent transmission problems and hardware damage caused by this, we recommend galvanic isolation using an external isolator (e.g. W&T RS422/485-Isolator Type 66201).

DIP switch settings

Mode	SW1	SW2	SW3	SW4	SW5	SW6	SW7	SW8
RS422, RS485 4-wire bus master	OFF	OFF	OFF	OFF	ON	Term.	OFF	OFF
RS485 4-wire automatic control	OFF	ON	OFF	OFF	ON	Term.	OFF	OFF
RS485 2-wire automatic control	ON	ON	OFF	OFF	OFF	Term.	OFF	OFF

Pin assignment and function RS422/485, DB9 male

Pin	Direction	Signal	Description	Default function (*)
1	OUT	TxD A/-	Transmit Data A	Data out
2	IN	RxD A/-	Receive Data A	Data in
3	OUT	RTS A/-	Ready To Send A	Handshake out
4	IN	CTS A/-	Clear To Send A	Handshake in
5	---	GND	Signal Ground	---
6	OUT	TxD B/+	Transmit Data B	Data out
7	IN	RxD B/+	Receive Data B	Data in
8	OUT	RTS B/+	Ready To Send B	Handshake out
9	IN	CTS B/+	Clear To Send B	Handshake in

(*) Applies only to the hardware handshake setting

Operation modes

The DIL switches are used to set the following modes:

- **RS422, RS485 4-wire bus master**
Provides one data and handshake channel each in each direction. The RS422/485 drivers and receivers are always active in this mode.
- **RS485 4-wire with automatic control**
One data channel is available in each direction. The RS485 driver chip is automatically activated each time data is sent out and then disabled when data is finished sending. The receive channel is always active in this mode.
- **RS485 2-wire bus with automatic control**
One data channel is available in each direction. The RS485 driver chip is automatically activated each time data is sent out and then disabled when data is finished sending. The receive channel is deactivated when the driver is on, and on when the driver is disabled.

Handshake for RS485 modes

RS485 bus systems do not use flow control in the traditional sense for data integrity, but rather a logical protocol. The handshake procedure for the Com-Server must therefore be set to NO (see *The serial parameters (Menu: UART Setup)*).

Terminating

All RS485 modes require a termination network on the bus system which ensures a defined rest state in the high-ohmic phases of bus operation. Connection of the bus system with a termination network can be done in the interface by closing the DIP switches 6 and 7 on the module:

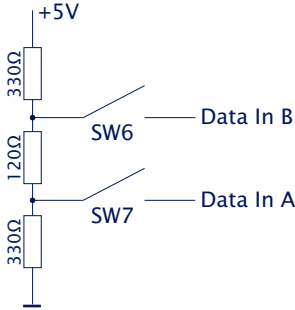

Wiring examples

RS422 connection with hardware handshake

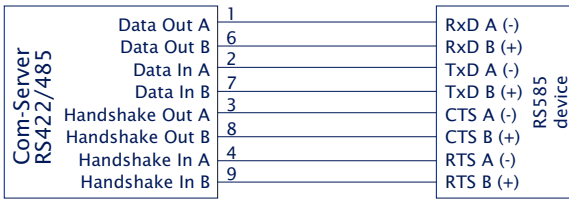

RS485 connection (4-wire bus master)

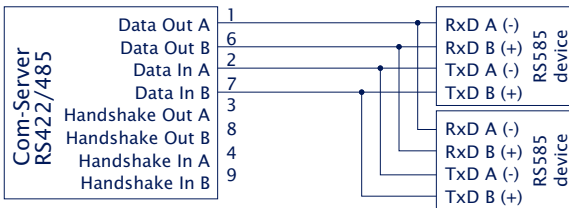

RS485 connection 2-wire

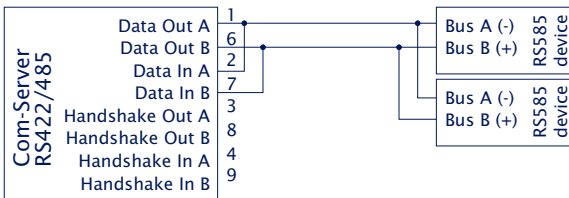

5.4 20mA/TTY interface

Der Com-Server 20mA 58664 is equipped with a 20mA/TTY module.



The maximum permissible baud rate of a Com-Server 20mA 58664 is 19.200 bit/s.

The send and receive loops can be operated through the external interface circuit independently of each other either actively or passively. In active mode the Com-Server provides the loop current for the respective 20mA loop, whereas in passive mode the connected device must provide the loop current. Example circuits for the module in active and passive mode can be found in the following section.

Pin assignment and function 20mA, DB9 male

Pin	Direction	Signal	Description/function
1	OUT	Data Out 20mA	Current Out +20mA
2	OUT	Data Out +	Data Output+
3	OUT	Data Out -	Data Output-
4	--	Data Out GND	Current Out Ground
5	IN	HD/	Halbduplex control
6	OUT	Data In 20mA	Current In +20mA
7	IN	Data In +	Data Input+
8	IN	Data In -	Data Input-
9	--	Data In GND	Current In Ground

Halbduplex-/2-wire-mode

Placing a GND level on Pin 5 of the SUB-D connector allows the module to be placed in half-duplex mode, in which there is echo suppression of the sent signals.

Wiring examples

Com-Server Tx and Rx loop active

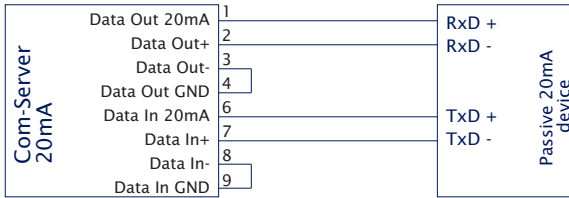

Com-Server Tx and Rx loop passive

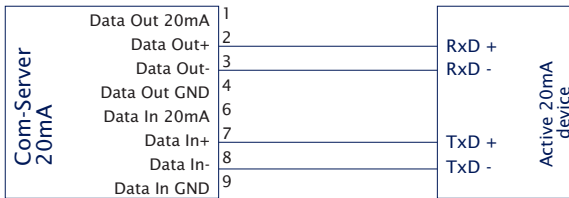

Com-Server Tx loop active, Rx loop passive

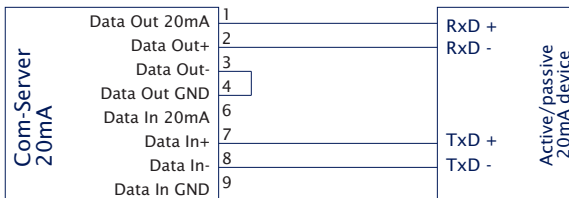

6 LED displays

- Power, Status , Error LED
- Network LEDs

6.1 LED displays

Power-LED



On indicates that power is present on the external screw terminals or via PoE.

Status-LED



Rapid continuous flashing = bootup, no IP
 Rapid continuous flashing (approx. 3x/s) indicates that the Com-Server is in the bootup phase and/or has not yet been assigned an IP address. Please use WuTility for example to assign the Com-Server an IP address.

Slow continuous flashing = connection
 Periodic flashing (1/s) indicates that the port has a valid connection to another network station. The status of the serial port can also be read out using WBM or the Com-Server's Telnet configuration tool.

Error-LED



The Error LED uses various flashing patterns to indicate error conditions on the device or serial port. The error texts for the previous five serial faults and the associated system time (time between the last restart of the Com-Server and when the error occurred) can also be read out using the Telnet configuration tool.

Rapid continuous flashing = IP address conflict
 The *IP Address Conflict Detect* function is activated and the Com-Server has detected an IP address conflict. This means the current IP address of the Com-Server is also used by other stations in the network. To prevent further problems, please contact the responsible network administrator and have the conflict resolved.

2 x flashing = Check serial data format

The serial port received at least one character with a parity or framing error (= parity error / framing error), or the data register of the serial receiver ship was written even though the previous character was not read out. Check the correctness of the serial parameters, the handshake procedure and the connection cable.

3 x flashing = Check serial handshake

The serial connected device is not responding to the handshake stop signal set by the Com-Server and continues to send data. The result can be that the serial ring memory is overwritten and data are lost. Check the handshake configuration of the device as well as the wiring of the connection cable.

All LEDs on = Self-test error

The self-test performed after each start or reset of the Com-Server could not be correctly finished. This error can occur when you have prematurely broken off a software update and the full operating software could not be transferred. The Com-Server is no longer capable of being operated in this condition. Repeat the software update over the network (see *Firmware update of the Com-Server*), and address the Com-Server using its assigned IP address.

If the fault cannot be remedied, the problem may lie with the hardware.

**Speed**

OFF: Simultaneous illumination/flashing of the Link/Activity LED means there is a link to a device at a rate of 10 MBit/s (10BaseT).

ON: Simultaneous illumination/flashing of the Link/Activity LED means there is a link to a device at a rate of 100 MBit/s (100BaseT)

**Link/Activity**

OFF: The Com-Server is not detecting a Link pulse from a hub or switch. Check the cable or the hub port.

ON: The Com-Server has a valid link to a hub or switch. The Speed LED indicates the data rate in this case.

Flashing: The Com-Server is receiving or sending network packets

7 Configuration access to the Com-Server

After completing the hardware installation and assigning the IP address, the remaining Com-Server configuration takes place over the network. Here either a Telnet client or, after it has been activated, an Internet browser can be used.

- Telnet configuration under Windows

- Configuration with the Internet browser

7.1 Configuration menu structure

The setup of the Com-Server is treelike. An overview of all the levels can be found in the following illustration.

Prior to configuration a valid IP address must have been already assigned to the Com-Server (see “Assigning the IP Address”). Access is then possible from virtually any computer having network access and an installed TCP/IP protocol.

A detailed description of both configuration access types, their conditions as well as the respective navigation within the menu tree can be found in the following section.

 *HTTP(S) protocol and its standard ports 80 and 443 are frequent targets of Web attacks. In order not to impair data throughput of the applications and of the Com-Server, Web Based Management is therefore factory disabled. Ways of activating this as part of the startup process can be found in the section on Web Based Management.*



If you exit the configuration menu by closing the Telnet connection without first invoking SAVE Setup, the original configuration is retained.

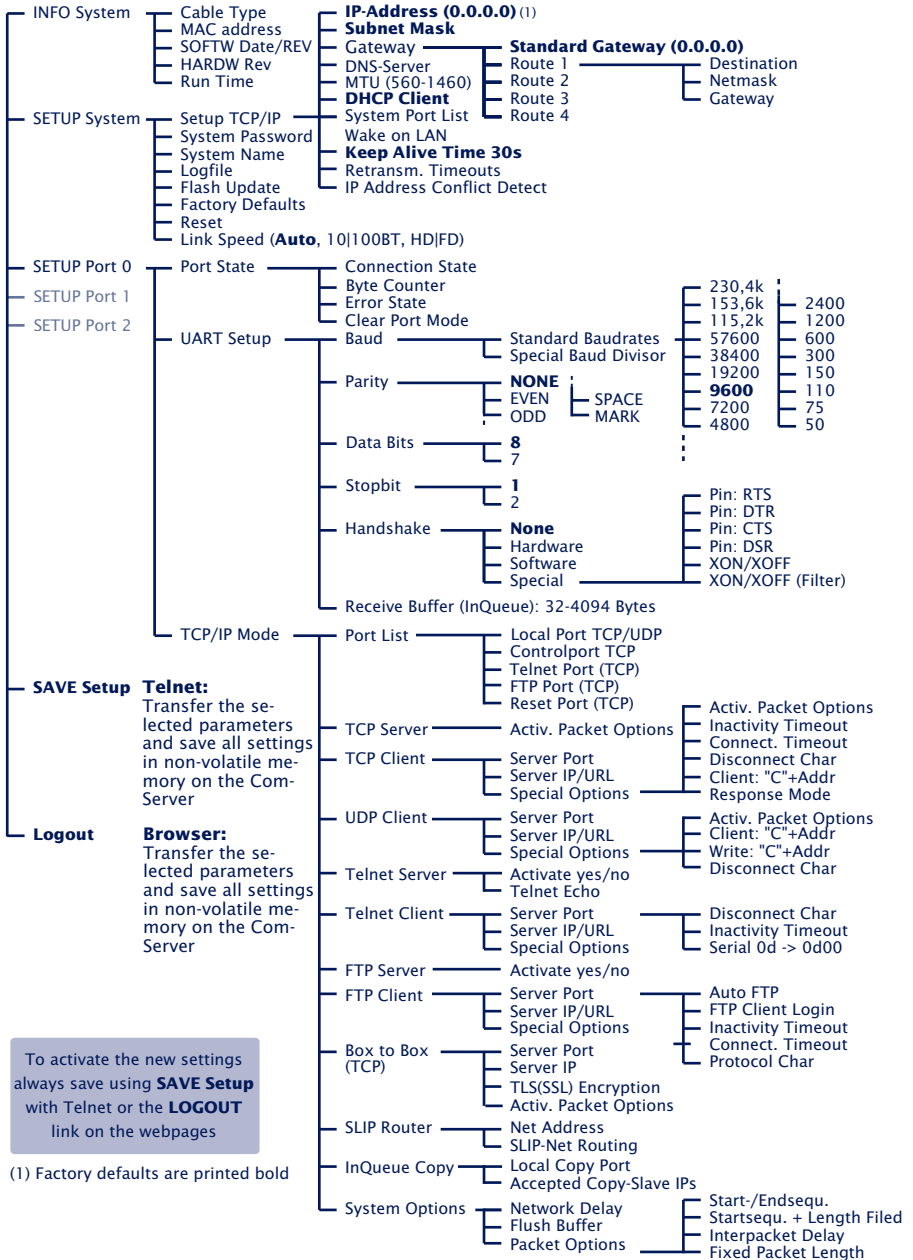

7.2 Configuration via Telnet

On Unix/Linux systems as well as Windows up to XP the telnet client is included in the standard installation of the operating systems.

The TCP port number for the telnet configuration is configurable in menu path *Setup Port x* → *TCP/IP Mode* → *Port List* → *Telnet Configuration Port*. The factory default port number is *1111*, so that you must start the connection from within the telnet client using the corresponding parameter:

```
telnet [IP-Adresse] 1111
```

With Windows Vista the telnet client must be explicitly installed together or after the fact. Here we recommend starting using the WuTility inventorying and management tool. If the telnet client is not installed on the respective system, an alternate telnet client (putty.exe) is automatically used.

If the connection could be opened and no system password is assigned (= factory default setting), you will see the following menu in your Telnet window. If a system password was configured, this will be asked for in front of the menu.

```
*****
* Com-Server [model name] *
* "COMSERVER-0A1B2C" *
*****
1. INFO System
2. SETUP System
3. SETUP Port x (Serial)
4. SAVE Setup
```

7.2.1 Navigation within the Telnet menu

An overview of the entire Com-Server configuration menu is shown on the previous page. On the monitor you will see

always just one level of the selected menu. Simply entering the number of the desired menu and pressing the *ENTER* key takes you to the next level. Entering a *q* or pressing the *ENTER* key takes you back to the previous menu level.

The last configured value of a menu item appears in parentheses. If you make changes, the new value will appear at this point the next time the menu is opened. It only becomes effective in the Com-Server itself however if you have saved it using *SAVE Setup*.

As long as you do not open this menu item, you can move around in the entire menu and change values without actually changing anything.

i *Positioning functions for the cursor (arrow keys) or correction actions (backspace, insert) are not available within the telnet configuration and, if used, will result in faulty inputs. If you make a typing mistake, exit the menu item using <Enter> and then repeat the entire entry.*

7.3 Configuration via Browser - Web Based Management

The Com-Server can optionally be configured via browser via HTTP (unencrypted) or HTTPS (encrypted). The WBM (Web Based Management) menu structure is largely compatible with the Telnet configuration.

7.3.1 Activating „WBM via HTTP“

The unencrypted WBM via HTTP can already be activated when the IP parameters are assigned with WuTility or via the serial interface. For details, see the chapters *IP Configuration Using WuTility* and *IP Configuration Using the Serial Interface*.

Subsequent activation on a Com-Server that is already in operation can be carried out via the Telnet configuration. Start a Telnet session on port 1111 of the Com-Server. In the menu branch

SETUP System → Setup TCP/IP → System Port List → WBM-Port → HTTP-Port

Enter the decimal number of the desired TCP port under which you want to reach the WBM. Then press the Return key until you are back in the main menu and from there open the *SAVE Setup* item. After you have quit the Telnet session, you can now access the Com-Server using an Internet browser.

If the use of the HTTP standard port 80 is not possible or not desired, the different port number must be explicitly specified in the address line of the browser when calling the Com-Server homepage:

http://[IP address or hostname]:[portnumber]

7.3.2 Activating „WBM via HTTPS“

Encrypted WBM via HTTP can only take place after the unencrypted WBM has been activated. Call the HTTP start page of the Com-Server from the address line of your browser:

http://[IP address or hostname]:[portnumber]

After logging in, navigate to the subpage *Setup System* and follow the *System Ports: Table* link.

Com-Server "ComServer-C09035"

>> SETUP System >> System Ports

WBM-Port (TCP) :	<input type="text" value="HTTP (80)"/>	<input type="text" value="80"/>
Certificate :	Management	
Telnet Configuration Port (TCP) :	<input type="text" value="1111"/>	
SNMP Port (UDP) :	<input type="text" value="161"/>	
Device Reset Port (TCP) :	<input type="text" value="8888"/>	
Init Flash Update Port (TCP) :	<input type="text" value="8002"/>	
Read Config Port (TCP) :	<input type="text" value="8003"/>	
Write Config Port (TCP) :	<input type="text" value="8004"/>	
Info Port (UDP) :	<input type="text" value="8513"/>	

[Back](#)

Change the setting of the WBM port from *HTTP* to *HTTPS* and enter the required port number (HTTPS standard port = 443). After clicking *Send*, navigate to the logout page using the back link of the Web pages and choose *Save*.

The Com-Server is now only accessible via HTTPS under the configured port number. When entering the address in your browser, use the prefix *https://*:

https://[IP address]:[portnumber]

 *The compute-intensive TLS encryption functions can influence the latencies of serial data transmission. Time-critical serial protocols should therefore be tested for compatibility with parallel HTTPS access. This especially includes possible security scans in the network. These may open a large number of TLS connections within a short period of time and can therefore lead to interruptions or timeouts of the serial data traffic.*

7.3.3 Starting and navigating the WBM

Depending on whether the WBM is activated via HTTP or HTTPS, you call the start page of the Com-Server using one of the following URLs in the address bar of your browser:

http://[IP address]:[portnumber]

https://[IP address]:[portnumber]

If the HTTP standard ports 80 (HTTP) or 443 (HTTPS) was configured for WBM, you do not need to explicitly indicate the port number in the address line.

You will now be given the start page of the Com-Server with the system password prompt. The factory default setting is *no* system password, so that you can get to the configuration menu by simply clicking the login button with an empty password field.

Com-Server "ComServer-0764BB"

Password:



Navigation

Since the WBM of the Com-Server is session-oriented, you must use *backlinks* and corresponding control buttons to

navigate to the individual Web pages. Using the Back function in the browser can lead to problems in accepting the set parameters.

You can make as many settings as desired during a configuration session. Pressing the *Send* button in the respective pages pastes them to a clipboard. Once all the settings have been made, always exit the configuration session using the link *Logout* and the *Save* button there. Only then are the settings you made copied into the non-volatile memory of the Com-Server and activated.

Com-Server "ComServer-0764BB"



<< LogOut >>

Save new configuration

Exit without saving

Restore Factory Defaults

Open port for an update from a non-Windows system

Reset without saving



Save button causes the Com-Server to save all the changes you made in its non-volatile memory and quits the configuration session.



The *Abort* button causes the Com-Server to reject all the settings you made and quits the configuration session.



The *Restore Defaults* button resets the Com-Server to its original factory setting. All settings including the network parameters are lost.

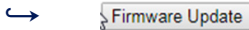

The *Firmware Update* button activates the mode in which the Com-Server expects a firmware update via TFTP protocol (see section *Firmware Update of the Com-Server*). Update mode can be exited only by complete transmission of a valid firmware or by interrupting the supply voltage. When using the *WuTility* tool for the firmware update, this mode is automatically started. In this case a manual start is not necessary.

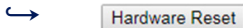

Restarts the Com-Server the supply voltage. Data from any other opened connections to the Com-Server are lost in this event.

 *The functions located on the logout page of the Com-Server can also be found in the Telnet menu branch SETUP System → Setup TCP/IP.*

7.3.4 Certificate management

HTTPS is based on the TLS protocol on the network side, which implements the encryption of communication and the authentication of communication partners via certificates.

The Com-Server identifies itself ex works with a self-signed default certificate, which is usually evaluated by browsers as a security risk. If the application requires secure authentication, the Com-Server must be equipped with an individual certificate signed by a trustworthy certification authority.

 *For more information on security, refer to the Network Security chapter in the appendix of this manual.*

The certificate management of the Com-Server can be found on the following website:

SETUP System → System Ports: Table → Certificate Management

 **Informations for Certificate Signing Request:**

Common Name :

Organization Name :

Organizational Unit :

City or Locality :

State or Province :

Country (2 Letter Code) :

Email-Address :

Alternative Names :

CSR : *Generates a private key and checks the informations*

Here it is possible to generate a CSR (Certificate Signing Request) with a new key pair and individual content.

By clicking on the *Check* button, the entered values are formally checked and the new key is generated. The new CSR can be downloaded via the Download button.

Self-signed Certificate

Self-signed Certificate : *Creates and installs a self-signed certificate.
Install and reset now:*



A previously generated individual CSR can be self-signed by the Com-Server with the private key belonging to the CSR.

Upload Certificate/Certificate Chain

Upload Certificate : *The certificate must be DER/PEM encoded,
the accepted length of certificate, including chain, is 54k*

 Keine ausgewählt

Upload Certificate Chain : *The certificate chain must be DER/PEM encoded*

 Keine ausgewählt

A CSR that has been generated and downloaded before can be loaded into the Com-Server as a certificate by an external certification authority after it has been signed. If a certificate chain belonging to the certificate is not already part of the certificate file, it can then be uploaded separately. The files can be in PEM or DER format.

Install Certificate/Chain

Install Certificate/Chain : *The device will reset after leaving this session.
Install and reset now:*

A previously uploaded certificate including the associated certificate chain is installed in the Com-Server and used as a certificate within TLS connections after it has been saved via the logout page.

8 The basis configuration of the Com-Server

Here follows the explanation of all the configuration possibilities related to the Com-Server operating system and which are not directly related to the serial ports.

- Save settings
- Menu: INFO System
- Menu: SETUP System

8.1 Save your settings

When configuring using either Telnet or Web Based Management, all the changes are first saved only temporarily in the Com-Server. To make sure the settings remain intact even after a reset or power failure, each configuration session must be ended with an explicit save procedure.

Telnet

From the main menu select *SAVE Setup*. Respond with *y* to the *Save Changes ?* prompt. If a correct entry was made, the text *Saving...* will appear on the monitor, and the Com-Server saves all the settings you made in its non-volatile memory. Once the data have been saved, they are activated each time the Com-Server is turned on or reset.

Entering anything other than *y* or simply pressing the ENTER key returns you to the main menu without saving the values.

 *Exceptions are the network parameters IP address, subnet mask and gateway, since these are also relevant for the running configuration session. To save and activate these you must enter *q* to quit the Telnet configuration after executing *SAVE Setup*. The Com-Server then autonomously performs a reset and only then begins to work with the new settings.*

Browser

Press the Save button on the Logout page. All changes will be saved and activated. If basic network parameters have been changed, the Com-Server automatically restarts if necessary.

8.2 Menu: INFO System

This menu allows you to call up device-specific parameters such as the version number and creation date of the firmware, MAC address of the unit, etc.

↪ **Cable type**

Indicates whether the connection to the hub/switch is using 10BaseT or 100BaseTX. The duplex procedure is also indicated (Full- or Half-Duplex).

↪ **MAC address**

Shows the Ethernet address of the Com-Server. This number is factory set and registered. It cannot be changed.

↪ **SOFTW Date/Rev.**

Shows the creation date and version number of the operating software in flash.

↪ **HARDW Rev.**

Shows the version status of the Com-Server hardware.

↪ **Run Time**

Shows the time in hours and minutes since the last Com-Server restart.

8.3 Menu: SETUP System

This menu is for configuring all the parameters that pertain to the Com-Server operating system and are independent of the serial interface.

8.3.1 Menu: SETUP System → Setup TCP/IP

↪ **IP-Address** (Default= 0.0.0.0)

Enter here the IP address if you want to change it. Please note that this number is not freely selectable, but rather needs to be specified based on the network address of the TCP/IP network. The format corresponds to the normal syntax (e.g. 172.16.231.5).

↪ **Subnet Mask** (Default = 255.0.0.0)

Enter the subnet mask of the subnet in which the Com-Server is located (e.g. 255.255.255.0).

↪ **Gateways** (Default = 0.0.0.0)

In this menu branch the IP address of the standard gateway or router can be configured. If you have not configured fixed routes, the standard gateway is used for all network packets whose destination IP address is not in the local subnet.

↪ **Route 1 - 4 (Destination, Netmask, Gateway)**

In addition to the standard gateway, up to four fixed routes can be defined. Packets whose destination addresses are in the networks configured here (=destination) are always sent through the gateway assigned to this route. A fixed route is only accepted and stored by the Com-Server if the following check is true:

Destination AND Netmask == Destination

 *Changes to the system parameters IP address, Subnet Mask, Gateway and Route 1-4 cannot be activated right after saving. The Com-Server will use these values only after closing the current Telnet connection using q.*

↪ **DNS Server** (Default: 0.0.0.0)

The entry contains the IP address of the DNS server (Domain Name System). The latter is needed in all client modes of the Com-Server (TCP, UDP, Telnet, FTP client) if the destination system is to be stored in the configuration not as a numerical IP address, but rather in the form of a host name or URL. The name is resolved by the Com-Server is done via UDP using standard port 53 reserved for the DNS.

The Time-To-Live of the IP address resolved for a host name is determined by the Time-To-Live parameter contained in the response from the DNS server. After the name has been successfully resolved this time is displayed in the menu item *Setup Port x* → *Port State* → *Connection State*.

↪ **MTU – Maximum Transfer Unit** (Default: 560)

This value determines the maximum size of a TCP/IP packet. It refers to the number of bytes (excluding header) that can be sent in a packet. The smaller the MTU, the more network buffer overall is available in the Com-Server. The selectable range begins at 560 and ends at 1024 bytes. The values can be set in increments of 128 bytes (automatic correction).

↪ **DHCP Client** (Default: 1 = ON)

The DHCP protocol is activated with the factory settings (menu entry = 1). The Com-Server attempts to find a DHCP server and get an IP address from it. Entering 0 deactivates DHCP and the Com-Server works statically with the IP address assigned to it. More information on how DHCP works can be found in the section IP Assignment via DHCP Protocol.

 *To prevent unintended address assignments or changes, we recommend deactivating the DHCP protocol if it is not expressly used in the respective network environment.*

↳ System Port List

From the respective submenus you can configure and disable the TCP and UDP port numbers under which the following configuration and control accesses for the Com-Server are reached. Entries are made in decimal. The value 0 disables the service.

The TCP/UDP ports with access to the serial port on the Com-Server can be configured from the submenu *Setup Port x* → *TCP/IP Mode* → *Port List* konfiguriert werden.

- WBM Port (Default = TCP/0)
Chapter *Configuration via Browser*
- Telnet Configuration Port (Default = TCP/1111)
Chapter *Configuration via Telnet*
- SNMP (Default = UDP/161)
Chapter *SNMP management*
- Device Reset Port (Default = TCP/8888)
Chapter *Reset of the Com-Server*
- Init Flash Update Port (Default = TCP/8002)
Chapter *Firmware update of the Com-Server*
- Read Config Port (Default = TCP/8003)
Chapter *Up-/Download configuration data*
- Write Config Port (Default = TCP/8004)
Chapter *Up-/Download configuration data*
- Info Port (Default = UDP/8513)
Chapter *Inventory via UDP*

 *Changes to the factory default port numbers as well as disabling services should be done with caution, since they can result in malfunction of configuration and management tools such as WuTility. If for example the telnet configuration and WBM are disabled, you can no longer configure the Com-Server. Restore the factory default*

values by performing a hardware reset of the Com-Server.

↳ **Wake on LAN** (Default: deactive)

Up to three Ethernet addresses for network components can be configured, which are enabled when there is a re-start of the Com-Server via Wake-on-LAN.

 *For proper function of Wake-on-LAN it must be supported and activated by the BIOS and the network card in the destination computer.*

↳ **Keep Alive Time (sec)** (Default: 30s)

If the keep-alive check is activated by entering and saving a value in second ticks, all TCP connections are monitored for network-side data traffic. If there is no network traffic within the set time, the Com-Server generates a keep-alive packet. If the partner does not answer this packet, the connection is reset in the Com-Server. This deletes any data still contained in the serial in- and output buffers.

Example: A TCP client has opened a connection to TCP server port 8000 of the Com-Server and the network connection is interrupted. After the set keep-alive time plus 2s for two repetitions has elapsed, the Com-Server closes the connection and is again ready for any other clients.

↳ **Retransmission Timeouts (ms)** (Default: 240)

This timeout determines what time must elapse before network packets are repeated if necessary. In most networks the default setting of 240ms can be used. Only when there are very long latency times between the Com-Server and its respective communications partner would you need to increase this value.

↳ **IP Address Conflict Detect** (Default: deactive)

Firmware version 1.31 and higher enables the Com-Server to detect and display an IP address conflict. An active check is performed each time the Com-Server is restar-

ted. Only passive monitoring is performed during normal running. Details on this functionality can be found in RFC5227, IPv4 Address Conflict Detection.

If the Com-Server detects that its current IP address is also being used by another station in the local network, it indicates this conflict by rapid flashing of the Error LED. In addition a corresponding message including the competing MAC address is generated in the Error State (*Setup Port x → Port State → Error State*).

When using a static IP address the conflict is only indicated. The Com-Server continues to use this IP address. In a DHCP environment the Com-Server informs the responsible DHCP server, resets the IP address and waits for assignment of a corrected IP address.

 *IP address conflicts generally lead to communication problems which are difficult to diagnose. Please therefore inform the responsible administrator in such cases.*

8.3.2 Menu: SETUP System – System Password

The system password, which consists of any 31 (max.) characters, protects against any subsequent configuration and control access to the Com-Server.

- Telnet configuration menu (Default = 1111/TCP)
- WBM (if enabled)
- Init Flash Update Port (Default = 8002/TCP)
- Read the configuration file (Default = 8003/TCP)
- Write the configuration file (Default = 8004/TCP)
- Reset Com-Server (Default = 8888/TCP)
- Reset Port Status (Default = 9084/TCP)
- Controlport (Default = 9094/TCP)
- SNMP (Default = 161/UDP)

On Telnet port 1111 and on WBM port the system password is

prompted as soon as the connection is opened. For all other associated TCP ports the password must be null-terminated (= [*password*] + 0x00) and sent to the Com-Server no later than 2s after the TCP connection has been established. Queries from SNMP managers are only responded to by the Com-Server if the community corresponds to the system password.

For additional information on using system passwords in conjunction with the configuration and control ports, see the section *Expanded Services of the Com-Server*.

8.3.3 Menu: SETUP System → System Name

The freely configurable system name consisting of max. 31 characters is used to identify the Com-Server. This name is displayed as an opening message in the client for all Telnet sessions.

If the tag *<wut/>* is used inside the system name, the Com-Server replaces it each time there is an output or communication with the last three places of its Ethernet address.

8.3.4 Menu: SETUP System → Logfile

The Logfile contains the last (max. 3000) connections and connection attempts for configuration accesses by the Com-Server with the associated time stamp and address parameters.

Accesses to the following services are registered:

- Telnet configuration menu (Default = 1111/TCP)
- WBM (0 = disabled)

- Init Flash Update Port (Default = 8002/TCP)
 - Read the configuration file (Default = 8003/TCP)
 - Write the configuration file (Default = 8004/TCP)
 - Reset Com-Server (Default = 8888/TCP)
 - Reset Port Status (Default = 9084/TCP)
- ↪ **Activate Logfile** (Default= 0 = OFF)
A 1 activates recording. In addition the Save Interval must be configured to a valid value.

- ↪ **Save Interval (min)** (Default= 0)
Configuration of the time interval in minutes at which the Logfile is written to the non-volatile memory of the Com-Server.

 *Saving the Logfile has an influence on the latencies of the serial data transmission. We recommending configuring the Save Interval only as low as absolutely necessary. When timeouts occur in serial data exchange, logging should be disabled on a test basis.*

- ↪ **Delete Logfile**
Deletes the entire Logfile including the non-volatile stored entries.

Reading/Viewing the Logfile

The Logfile can be viewed using the Web Based Management of the Com-Server under Setup System r Logfile r Load. The Logfile can be downloaded via TFTP. The name to be specified in the TFTP client must be *wut_cs_logfile*. (Note period at the end!)

8.3.5 Menu: SETUP System → Flash Update

Before you activate the update mode, make sure that you have quit any active network connections. Then confirm with „y“. The update mode is indicated by lighting of the Status LED on the Com-Server.

WuTility automatically enables update mode through TCP port 8002. Manual enabling is therefore only necessary if this port is blocked, such as by a firewall.

 *You may quit the update mode only by either completely performing the update or by means of a reset, i.e. turning off the power!.*

8.3.6 Menu: SETUP System → Factory Defaults

Enter a y to restore the factory default settings.

 *Resetting the non-volatile memory causes loss of all the settings which deviate from the default values, including the IP address.*

8.3.7 Menu: SETUP System → Reset

Select this menu item to perform a software reset on the Com-Server. First your Telnet connection is properly closed.

 *All data from any still open network connections are lost.*

8.3.8 Menü: SETUP System → Link Speed

The Com-Server is factory set for autonegotiation. Data transmission speed and duplex procedure are automatically negotiated with the connected switch/hub and set correspondingly.

In addition to autonegotiation, the Com-Servers as well as many manageable switches can be configured for fixed transmission parameters with respect to speed and duplex procedure. To prevent communications problems (duplex mismatch), only the following two combinations are permitted:

- *Both* parties (switch and Com-Server) are operated in Auto-Negotiation mode (recommended).
- *Both* parties are configured for the same (fixed) transmission speeds and duplex mode.

 *Changing the link speed is activated only after saving and exiting the telnet or WBM session by means of an automatic Com-Server reset. Data from any open network connections is lost. If the newly selected setting is not supported by the port used on the switch or hub, the Com-Server may then not be accessible.*

8.4 Menu ... → TCP/IP Mode → System Options**↳ Network Delay [10ms-Ticks]
Default: 0000)**

This value specifies the minimum delay time of the Com-Server after serial data have arrived. After this time has expired, it packs the data into a network packet and sends them to the respective communications partner. The default setting 0 means the attempt is made to send the data as quickly as possible. The resulting high time transparency does however bring with it the drawback of a higher number of network packets.

If the serial transmission takes place in predictable block sizes, this value can be adjusted to optimize the network load. There is also the advantage that the serial blocks are transmitted within a network packets, so that they arrive at the receiver bundled.

Example:

You are using serial data blocks of 25 bytes each and transmission parameters of 9600 baud, 8 data bits, no parity and 1 stop bit. Each block thus has a length of approx. 26ms ($1/9600 * 10 \text{ bits} * 25 \text{ bytes}$). If the network delay is set here to a value of 3 (=30ms), each block is sent to the receiver with a network packet.

i *The situation described here applies only to a non overloaded and error-free network. If there are interruptions in the data flow on the network side, any serially accumulated data are also sent in larger network packets. For secure closed transmission of serial datagrams in a network packet we recommend the use of Packet Options. For details, see the section on Packetizing serial datagrams.*

↳ **Flush Buffer** **Default: active**

If this switch is *active*, the serial buffer is cleared each time a new connection is opened; any residual data which cannot be transmitted (e.g. handshake stop of the serial terminal device) are thus lost. But if you connect a terminal device to the Com-Server which for example requires a longer handshake stop for program reasons, you can prevent clearing of the buffer by deactivating the switch. In this way multiple connections can be opened one after the other on the network side and the data are accumulated in the buffer until they are sent.

↳ **Packet Options** **Default: deactivate**

The Packet Options in this menu branch are criteria which allow the Com-Server to detect the start and end of contiguous datagrams in serial receiving. They allow a serial datagram to be sent to the communication partner closed in a network packet. In addition to start/end sequences and fixed packet lengths, pauses can also be triggered in the data stream.

For details, see the section on *Packetizing serial datagrams*.

9 Configuration of the serial port

■ Configuring the serial transmission parameters

In addition to the usual settings for baud rate, data bits, parity and stop bits, the various handshake procedures and available special functions of the individual control signals are explained here.

■ Setting the TCP/UDP services with access to the serial port

9.1 The serial parameters (Menu: UART Setup)

All RS232 parameters relevant to operation are configured in the submenu *Setup Port x → UART Setup*. An overview of the entire configuration tree can be found in the section *Structure of the Configuration Menu*.

If you are using the device in conjunction with the *W&T COM Port Redirector*, it is not necessary to configure the serial parameters in the Com-Server. The *COM Port Redirector* automatically sets the parameters needed by the serial application in the Com-Server.

 *The settings only become active after saving with SAVE Setup or pressing Save on the Logout page.*

9.1.1 Baud rate, Data bits, Stop bits, Parity

The desired transmission parameters can be selected by entering the corresponding designation in the respective branch of the menu tree. Invoking *Save Setup* in the master menu or *Save* on the WBM logout page saves the changes you made in the non-volatile memory of the Com-Server and simultaneously activates them.

Freely selectable baud rate (Special Baud Divisor)

In the submenu Special Baud Divisor you can enter any desired divisor for generating the baud rate. This makes it possible to work even with non-standard baud rates. The baud rate and divisor are calculated using the following formulas.

↪ **Com-Server++ 58665, Com-Server 20mA 58664**

$$\text{Divisor} = \frac{83,329 \cdot 10^6}{32 \cdot \text{Baudrate}} \quad \text{Baudrate} = \frac{83,329 \cdot 10^6}{32 \cdot \text{Divisor}}$$

The maximum baud rate of RS232/422/485 Com-Server ports is 230,4kBd, which corresponds to a divisor of 11.

 *The maximum permissible baud rate of a Com-Server 20mA 58664 is 19.200 bit/s.*

↳ **Com-Server PoE 3x Isolated**

$$\text{Divisor} = \frac{7,3728 \cdot 10^6}{64 \cdot \text{Baudrate}} \quad \text{Baudrate} = \frac{7,3728 \cdot 10^6}{64 \cdot \text{Divisor}}$$

The maximum baud rate of the Com-Server 3x Isolated is 115,2kBd, which corresponds to a divisor of 1. 230,4kBd is only available as standard baudrate.

The currently configured baud rate is displayed when selecting the submenu *SETUP Port x (serial) → UART Setup*.

9.1.2 The handshake modes

(SETUP Port x → UART Setup → Handshake)

This menu provides three standard modes for flow control of the serial port. As opposed to these predefined handshake profiles, you can use the Special submenu to specify the function of each control signal individually. Details on the control line functions are contained in the description of the submenu *Handshakle → Special*.

 *The model Com-Server 20mA 58664 only supports the data channels Rx and Tx. No hardware handshake or other access to the control lines is possible with this model.*

↳ **Hardware handshake**

Flow control is handled using the RTS and CTS signals. The Com-Server only sends data to the serial device if the CTS input is High. In the opposite direction the Com-Server indicates readiness using the RTS line.

Function control signal:	RTS:	Flow Control
	DTR:	Show Connection
	CTS:	Flow Control
	DSR:	NO

↪ **Software handshake**

The software handshake is implemented using the two ASCII characters (11H)=XON and (13H)=XOFF. In the standard setting Software Handshake these two codes are considered by the Com-Server as control characters and are filtered out from the actual data flow in both directions. This filtering can be turned off individually for each data direction in the Special submenu.

Function control signal:	RTS:	NO (Default HIGH)
	DTR:	NO (Default HIGH)
	CTS:	NO
	DSR:	NO

↪ **NO handshake**

Turns off any hardware or software flow control for the serial interface. All the data are output to the connected terminal device regardless of the status of the inputs CTS and DSR. Any impending overflow of the serial input buffer is not signalled by the Com-Server. The setting NO Handshake makes sense for any data transmission that uses a serial protocol for data integrity or flow control.

Function control signal:	RTS:	NO (Default HIGH)
	DTR:	NO (Default HIGH)
	CTS:	NO
	DSR:	NO

↪ **Special**

Here it is possible to configure the function of the control lines differently from the three predefined protocols. Toggle between on and off by entering the menu number of the desired function. Settings made here are correspondingly overwritten by selecting one of the three predefined handshake modes.

↪ **Pin: RTS & Pin: DTR**

The following functions can be assigned to the outputs RTS and DTR:

1. Flow Control – If this function is turned on, the Com-Server handles the RS232 flow control through the corresponding output. The ready state for serial data is signaled by a HIGH signal (+3...12V). If the memory limit of the input buffer is reached, the line is set to LOW (-3...-12V).

2. Show Connection – The output is switched to the serial port depending on an existing TCP connection. HIGH (+3...12V) indicates an existing connection.

3. NO (Default=HIGH) – The outputs are not used by the Com-Server and carry a constant HIGH level (+3...12V).

4. NO (Default=LOW) – The outputs are not used by the Com-Server and carry a constant LOW level (-3...-12V).

↳ **PIN: CTS und PIN: DSR**

The inputs CTS and DSR can be assigned the following functions:

1. Flow Control – The serial flow control is performed using the corresponding pin. Serial data are output only if the input was set to HIGH (+3...12V) by the connected terminal device.

2. OPEN/CLOSE – Connection This option for TCP connection building and ending can be used to control connection building and ending in all Com-Server client operating modes. If the IP address and the TCP port are stored in the Com-Server, a HIGH level (+3...12V) on the corresponding input establishes a connection. The connection is closed with a LOW level (-3...-12V).

3. Accept only by HIGH – Connection establishment of a TCP client is only accepted if a HIGH level (+3...12V) is present on the corresponding input. Likewise the connection is rejected when there is a LOW level.

4. NO (Manual IN) – The selected input is ignored by the Com-Server.

↳ **XON/XOFF**

Here the handshake can be configured for XON/XOFF

separately for each data direction. *XON/XOFF Receive* switches processing of this control character for serial receiving on: After receipt of an XOFF sent by the RS232 terminal device, the Com-Server stops serial data output until it receives an XON. If *XON/XOFF Send* is turned on, the Com-Server generates an XOFF when it is no longer able to receive serial data.

↳ **XON/XOFF (Filter)**

If XON/XOFF is turned off for flow control, this option can be used to separately determine for both data directions whether the Com-Server filters these control characters out of the actual data.

1. Send-Filter (Data direction network → serial)

If this option is turned on and XON or XOFF characters occur in the actual data, the Com-Server filters them out and does not pass them along to the terminal device. Select this mode generally for bi-directional RS232 connections, since otherwise you will have problems with data traffic. If the Send-Filter option is turned off, all the data including the XON and XOFF characters are sent unfiltered on the RS232 interface. This mode only makes sense if the connected terminal device is a graphics printer whose data stream can be expected to contain handshake characters.

2. Receive-Filter (Data direction serial → network)

If this option is turned on, the Com-Server interprets the XON and XOFF characters sent by the serial terminal device as control bytes and does not insert them into the network data stream. This ensures that the recipient in the network only gets actual user data. If Receive-Filter is turned off, the XON and XOFF characters sent by the serial terminal device are transmitted to the network together with the actual user data. This mode requires of the respective recipient in the network that it be able to separate actual data from control data.

The currently selected parameters are shown in the top line of the *UART Setup* menu:

[Baud], [Parität], [Datenbits], [Stopbits], [Handshake]

Possible values for the handshake variables are:

		Send filter	Receive filter
[N]	No handshake	---	---
[H]	Hardware handshake	---	---
[S]	Software handshake Xon/Xoff	ON	ON
[Special]	Special >setting configuration menu „Handshake Special“	---	---

9.1.3 Receive Buffer (InQueue)

The Com-Server is factory configured with a serial input buffer capacity of 4094 bytes. The sub-menu Receive Buffer allows you to reduce this to 32 bytes, with only even values permitted.

In most applications the emphasis is on maximum data throughput, so we recommend not changing the maximum value of 4094. It does however make sense to reduce the value when working with serial protocols together with unreliable or noisy network connections. This prevents datagram repetitions from being accumulated on the part of the serial master when there are connection errors and keeps them from being sent in bundled form after the connection is resumed.

 *Please ensure that when communicating without serial flow control the Receive Buffer is at least as large as required for the longest expected serial data packet.*

9.1.4 FIFO Send/Rec (only Com-Server PoE 3x Isolated)

The submenu allows the FIFO memory of the serial receiver component to be turned on and off. It is recommended that the FIFOs be turned on to reduce the system load especially when sending large data quantities at high baud rates above 57600. If for example you need a short delay in sending data as possible when working with serial protocols, the FIFOs should on the other hand be turned off.

9.2 TCP-/UDP port numbers (Menu: TCP/IP Mode)

In the menu branch *Setup Port x → TCP/IP Mode → Port List* you can configure the TCP server ports for all services with access to the serial ports on the Com-Server. Changes to the port numbers must be set the same in the client-side communication partner. A value of 0 disables the service.

 *Changes to the factory-set port numbers as well as disabling services should be done with caution, since these can result in a connection break to any connected communication partners such as the COM Port Redirector. If the Local Port is disabled, no data exchange with the serial connected device is possible. The default values can be restored by resetting the Com-Server to its factory default settings.*

Local Port TCP

(Default = 8000/Port A, 8100/Port B, 8200/Port C)

Under this port number a data-transparent TCP connection to the serial port on the Com-Server is made available. The port is required for use in the operating modes *TCP Server*, *COM Port Redirector* and *Box-to-Box*.

For detailed information see chapter:

Data transfer per TCP/IP-Sockets
The Windows COM port redirector
Box-to-Box mode

Controlport

(Default = 9094/Port A, 9194/Port B, 9294/Port C)

The control port allows configuration of the serial port on the Com-Server over the network. Use of the control port is required for operation together with the *COM Port Redirector*.

For detailed information see chapter:

The Windows COM port redirector
The Controlport

Telnet Port/TCP

(Default = 6000/Port A, 6100/Port B, 6200/Port C)

The telnet port allows access to the serially connected device with a standard telnet client. The port is always required for Telnet Server mode.

For detailed information see chapter:

Telnet Server

FTP Port/TCP

(Default = 7000/Port A, 7100/Port B, 7200/Port C)

The FTP port enables access to the serially connected device with a standard FTP client. The port is always required for FTP Server mode.

For detailed information see chapter:

FTP Server

Reset Port Status

(Default = 9084/Port A, 9184/Port B, 9284/Port C)

For special applications this port offers the ability to carry out a forced reset of the Com-Server port: the parameters for the current connection are deleted.

For detailed information see chapter:

Reset Com-Server Port

10 Packetizing serial datagrams

Some serial protocols monitor the synchronous reception of datagrams with character delay time. When this timeout between two characters is exceeded the associated datagram is rejected or evaluated as a transmission error. In such environments it may be necessary to send serial datagrams closed in a packet on the network side as well.

- Packet Options
- Start-/Endsequence, Length Field
- Interpacket Delay
- Fixed Packet Length

10.1 Packet Options

Packet Options in the menu path *Setup Port x → TCP/IP Mode → SystemOptions* are criteria which allow the Com-Server to detect the start and end of contiguous datagrams in serial receiving. They allow a serial datagram to be sent to the communication partner closed in a network packet. Such datagram-optimized transmission is often necessary in tunneling and transmission of serial protocols which require synchronous reception of the data packets with a defined character delay time.

For serial protocols which emphasize the greatest possible latency-free transmission and shortest possible acknowledgement delay time, Packet Options should not be used. By factory default the Com-Server operates latency-optimized and sends received data as soon as possible to the respective communication partner.

 *Regardless of how Packet Options is configured, the Com-Server sends all received data to the network-side communication partner as soon as the set MTU is reached. The factory default setting for this is 560 bytes. In the menu path Setup System → Setup TCP/IP → MTU this can be increased to max. 1024 bytes.*

The set Packet Options apply to the following Com-Server modes.

- TCP client
- TCP server
- UDP peer
- COM redirector
- Box-to-Box
- OPC server

10.1.1 Startsequence/Endsequence

The Com-Server sends the datagram when one of the two configured Start AND End sequences has been received. If the network send will be triggered only by an *End Sequence*, *Start Sequence Size 1* and *Start Sequence Size 2* must be configured to 0.

↳ **Activate this Packet Option (Telnet)**

Activates the selected option for serial data reception.

↳ **Start Sequence Size 1/2**

Enter the length of the respective *Start Sequence* in bytes. The max. length is 3. A value of 0 deactivates monitoring of the Start Sequence.

↳ **Start Sequence 1/2**

Hexadecimal, space-delimited byte sequence of the respective *Start Sequence*. The input field is only activated if the *sequence size* was previously specified and sent to the Com-Server.

↳ **End Sequence Size 1/2**

Enter the length of the *End Sequence* in bytes. The max. Length is 3.

↳ **End Sequence 1/2**

Hexadecimal, space-delimited byte sequence of the respective *End Sequence*. The input field is only activated if the *sequence size* was previously specified and sent to the Com-Server.

↳ **Additional Bytes**

Number of bytes which follow after the *End Sequence 1* or *2* and belonging to the serial datagram (e.g. checksum)

Example 1:

Modbus/ASCII begins each datagram with the character : (0x3a). The end of the datagram is indicated by the character string *CRLF* (0x0d, 0x0a).

Start-/Endsequence	Start Sequence Size 1 :	1	Bytes
	Start Sequence 1 :	3A	hex
	Start Sequence Size 2 :	0	Bytes
	Start Sequence 2 :	Define first the Sequence Size!	
	End Sequence Size 1 :	2	Bytes
	End Sequence 1 :	0d 0a	hex
	End Sequence Size 2 :	0	Bytes
End Sequence 2 :	Define first the Sequence Size!		
Additional Bytes :	000	Bytes	

As soon as the Com-Server has received the character *0x3a*, it collects more data until the End Sequence *0x0d 0x0a* is received and then passes the datagram to the network.

Example 2:

The block end of a serial protocol is indicated by the character strings *CRLF* or *LFCR*.

Start-/Endsequence	Start Sequence Size 1 :	0	Bytes
	Start Sequence 1 :	Define first the Sequence Size!	
	Start Sequence Size 2 :	0	Bytes
	Start Sequence 2 :	Define first the Sequence Size!	
	End Sequence Size 1 :	2	Bytes
	End Sequence 1 :	0d 0a	hex
	End Sequence Size 2 :	2	Bytes
End Sequence 2 :	0a 0d	hex	
Additional Bytes :	000	Bytes	

The Com-Server collects incoming serial data until receipt of the End Sequence *CRLF* or *LFCR* and then passes the datagram to the network.

Example 3:

The block end of a serial protocol is followed by the character *ETX* (0x03) followed by a 16-bit checksum.

Start-/Endsequence	Start Sequence Size 1 :	0	Bytes
	Start Sequence 1 :	Define first the Sequence Size!	
	Start Sequence Size 2 :	0	Bytes
	Start Sequence 2 :	Define first the Sequence Size!	
	End Sequence Size 1 :	1	Bytes
	End Sequence 1 :	03	hex
End Sequence Size 2 :	0	Bytes	
End Sequence 2 :	Define first the Sequence Size!		
Additional Bytes :	2	Bytes	

The Com-Server collects incoming serial data until receipt of the character *ETX* (0x03) plus the next two following bytes and then passes the datagram to the network.

10.1.2 Startsequence + Lengthfield

The Com-Server sends the datagram after reception of a Start Sequence and evaluation of a length specification contained in the datagram.

- ↪ **Activate this Packet Option (Telnet)**
Activates the selected option for serial data reception.
- ↪ **Start Sequence Size**
Enter the length of the *Start Sequence* in bytes. The max. Length is 3.
- ↪ **Start Sequence**
Hexadecimal, space-delimited byte sequence of the respective *Start Sequence*. The input field is only activated if the *sequence size* was previously specified and sent to the Com-Server.
- ↪ **Length Field Offset**
Start position of the length field within the serial datagram in bytes. Counting method beginning with 0.
- ↪ **Size**
Length of the length field in bytes. In the protocol field defined by *Length Field Offset*, *Size* and *Byte Order*, the Com-Server expects specification of the total length of the serial datagram, including any *Start Sequence* and appended checksum. If the length specification is defined differently within the serial protocol, a corresponding correction may be needed using the *Additional Bytes* option.

 *Clean network-side packetizing is only assured if the serial datagrams do not exceed the MTU of the Com-Server. The factory default setting for this is 560 bytes. In the menu path Setup System → Setup TCP/IP → MTU this can be extended to 1024 bytes.*

↳ **Byte Order**

Organization of the length field (net order = high-byte-first; byte order = low-byte-first)

↳ **Additional Bytes**

Any number of bytes which may not be accounted for in the length specification of the serial protocol (e.g. *Start Sequence*, appended checksum, etc.). This means the contents of the field defined by *Size* may have to be corrected to the total length of the serial datagram using the *Additional Bytes* option.

Example

The serial protocol shown in the following always starts with the character *STX* (0x02). In the Length field the length of the following data field (serial data) is specified without the checksum and without the previous fields. The Block End is indicated by a variable 16-bit checksum.

Description	Start Sequence	Serial Address	Len-Field (Netorder)	Serial Data	CRC16
Size [byte]	1	1	2	x	2
Value	STX (02)	any	High/Low		any

The following settings must be made on the Comt-Server for correct packeting of this protocol structure:

☉ Startsequence + Lengthfield

Start Sequence Size : Bytes

Start Sequence : hex

Length Field

Offset : Bytes

Size :

Byte Order :

Additional Bytes : Bytes

As soon as the Com-Server has received the character 0x02 it collects additional data. If the total number of incoming cha-

acters is equal to the sum from the *Length field* and *Additional Bytes*, the datagram is passed to the network.

10.1.3 Interpacket Delay

The Com-Server structures the serial data stream based on a configurable rest pause in ms for serial reception. This means after receipt of any character the following data are collected until no more characters have been received within the time set as Interpacket Delay. Only now is the datagram passed into the network.

↪ **Activate this Packet Option (Telnet)**

Activates the selected option for serial data reception.

↪ **Interpacket Delay**

Enter the desired Interpacket Delay in ms. The permissible minimum value is 3ms. The tolerance is approx. 1 character length, as results from the serial parameters which are set.

 *Regardless of the configured Interpacket Delay the Com-Server sends incoming data to the network-side communication partner only once the set MTU is reached. The factory default setting for this is 560 bytes. In the menu path Setup System → Setup TCP/IP → MTU this can be extended to 1024 bytes.*

Example

Modbus/RTU separates datagrams using a rest pause of at least 3.5 character lengths. A baud rate of 9600 with data format 1 start bit + 8 data bits + 1 stop bit results in a character length of approx. 1 ms. For 3.5 character lengths this results a rounded-off Interpacket Delay of 4ms:

<input checked="" type="radio"/> Interpacket Delay	Inter Packet Delay : <input type="text" value="4"/> ms
--	--

10.1.4 Fixed Packet Length

The Com-Server structures datagrams based on a fix number of characters. This means datagrams are not passed to the network until the set number of characters has been received.

↪ **Activate this Packet Option (Telnet)**

Activates the selected option for serial data reception.

↪ **Fixed Packet Length**

Enter the desired number of characters.

 *The value set under Fixed Packet Length is limited to the size of the MTU. The factory default setting for this is 560 bytes. In the menu path Setup System → Setup TCP/IP → MTU this can be extended to 1024 bytes.*

Example

A serial device always replies to the polling from a master with a fixed datagram length of 30 bytes.

For correct packeting of this protocol the following settings must be made on the Com-Server:

<input checked="" type="radio"/> Fixed Packet Length	Packet Length : <input type="text" value="30"/> Bytes
--	---

11 Mode TCP-Server

The most direct way to exchange data with a serial device connected to the Com-Server is via TCP sockets. This is especially useful in cases where communication needs to be integrated into your own programs. Comparable to traditional telephony, TCP connections always consist of an active, calling side (=Client) and a passive, call-answering side (=Server). The TCP server operating mode offers network clients the possibility of direct and data-transparent access to the serially connected device.

■ The Com-Server as TCP-Server

11.1 The Com-Server as TCP server

TCP is a connection-based protocol, i.e. during data transmission there is a fixed connection between client and server. TCP possesses all the mechanisms for opening and closing a connection and ensuring errorless data transfer over the network.

The connection is controlled by the user program (client process), which opens (`connect()`) and closes (`close()`) the connection. Once a connection is established, data can be exchanged bidirectionally between the two processes. The Com-Server outputs all the data from the LAN to the serial port and in return reads in all the data from the serial port in order to convey it to your client process.

It must be noted that only one TCP client at a time can be connected to the serial port of the Com-Server. If there is already a connection, any attempt from another client is rejected until this first connection has been properly closed or ended by means of a reset.

 *When there is no connection, the entry FREE must be visible in the Com-Server port menu SETUP Port x → Port State → Connection State. If a connection is active, the entry In Use Port number <IP address> appears there.*

Application examples TCP-Server mode

- A separate client program should be created for polling the device serially connected to the Com-Server. TCP socket communication is supported by all modern programming and script languages.
- The communication program associated with the serial device offers as a standard feature the ability to specify an IP address/port number as the destination interface.

11.1.1 Configuration of the local port number

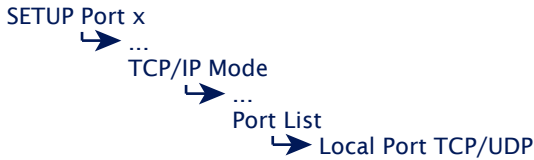

To open a connection to the Com-Server, a client needs an IP address and the TCP port number. Direct access via TCP to the serial port of the Com-Server is done using the port number stored in the menu branch *Setup Port x* → *TCP/IP Mode* → *Port List* → *Local port (TCP)*. Port number 8000 is pre-configured at the factory

11.1.2 Optional settings

Serial transmission parameters



Baud rate, data bits, parity and handshake procedure must conform to the connected serial device. For details see section *Configuration of the Serial Port*.

Serial receive buffer



The Com-Server has a variable serial receive buffer of approx. 4kB. The menu item allows this value to be reduced. Whether the serial receive buffer is automatically cleared when a connection is opened or any existing older data are sent to the

application is determined by the Flush Buffer option. Details can be found in the section *Basic configuration of the Com-Server*.

Flush Buffer

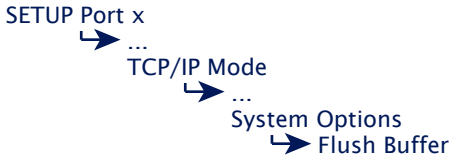

This option determines whether when a network-side connection is opened to the Com-Server the serial receive buffer is cleared (Flush Buffer = 1) or any existing data are sent to the client application (*Flush Buffer = 0*). Details can be found in the section *Basic configuration of the Com-Server*.

Packeting options for serial receive data

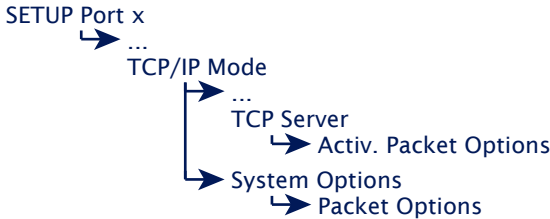

When sending serial protocols such as Modbus/RTU, it is often necessary to send serial received datagrams also closed on the network side in a TCP packet. The menu paths shown above offer various ways to parameterize serial packet limits (pause times, start-/end sequences, datagram lengths) and to activate their processing for the respective mode. Details can be found in the section *Packeting of serial datagrams*.

Network Delay

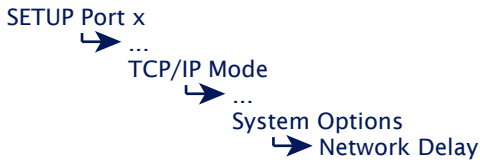

In its default setting the Com-Server attempts to send the serially arriving data to the network-side application with as little delay as possible. Particularly when working with host serial protocols it may be necessary to send the protocol blocks enclosed in a network packet if possible. The option *Network Delay* in *Setup Setup Port x* → *Setup TCP/IP* → *System Options* allows an artificial delay in transmission for this purpose. Details can be found in section *Menu ... Setup TCP/IP* → *System Options*.

Keep Alive Time



The factory default setting for the keep-alive check is 30 seconds. I.e. if there is no data traffic the Com-Server checks during the set time interval to see whether the connected network application can be reached. If there is no reply, for example due to a break in the network infrastructure, the Com-Server resets the connection internally and thus enables a new connection to be opened. Details can be found in section *Menu SETUP System* → *Setup TCP/IP*.

12 Mode TCP Client

Triggered by serial data reception or a serial control line the Com-Server opens the connection to a TCP server in TCP-Client mode as needed.

- TCP-Client mode with static addressing
- TCP-Client mode with serial addressing
- Connection opening and closing control

12.1 The Com-Server as TCP client

In contrast to the passive TCP server mode, in TCP client mode the Com-Server independently opens connections to a TCP server located in the network. The destination IP address and destination port number needed for this can either be stored in the configuration or sent serially to the Com-Server before the actual user data. A trigger for opening the connection could be serially received characters or status change of a handshake procedure. The connection is closed on a time basis or when a particular serial character is received.

If there is no connection to the TCP server currently active, the port itself can also be a TCP server and accept connections from clients on its default TCP port or on the port configured in the menu branch *Setup Port x → TCP/IP Mode → Port Number*.

After basic startup of the Com-Server and setting the serial transmission parameters in accordance with the connected device, the TCP client mode is configured in the Submenu *Setup Port x → TCP Mode → TCP-Client*.

Application examples TCP-Client mode

- The message generated irregularly from a serial device connected to the Com-Server should be received with a program specifically designed as a TCP server.

12.1.1 TCP client mode with fixed destination system

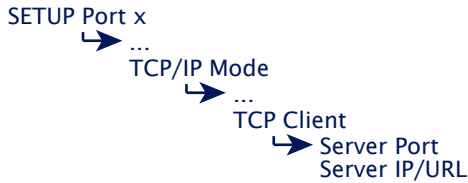

↳ **Server Port**

Port number that the application (TCP server process) addresses on the computer.

Format: decimal

↳ **Server IP/URL**

IP address or URL of the computer on which your application (TCP server process) is active.

Format: Dot notation or URL

i A URL can only be assigned in conjunction with a valid DNS server. The name used is not allowed to contain space characters (0x20), nor can the first character be a decimal (0x2E). A server IP or URL is deleted by entering 0.0.0.0. For additional information refer to the section Menu: Setup SYSTEM → Setup TCP/IP → DNS-Server.

Opening the TCP connection

After saving the connection data the Com-Server waits to receive any serial character. This is the trigger for opening the connection and is sent to the TCP server together with the following data.

If the *Direct Connect* option is activated under *Special Options*, the Com-Server establishes a permanent connection to the stored TCP server immediately after saving the connection data and after each restart.

Alternately the connection can also be triggered via hardware depending on the status of a handshake input on the serial port (CTS or DSR). Details can be found in section *Handshake modes* → *Special* → *Pin: CTS and Pin: DSR*.

If the opening and closing of the TCP connection is to be controlled exclusively via a handshake input (CTS or DSR), the inactivity timeout must be deactivated (*inactivity timeout* = 0) and no *disconnect char* must be configured.

Closing the TCP connection

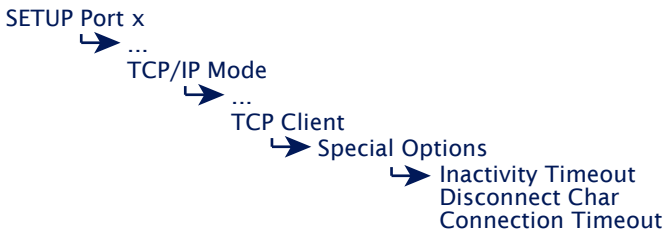

To close the connection the following methods from the Sub-menu *...TCP Client* → *Special Options* are available. If connection control is configured using the handshake inputs CTS or DSR, the connection is also closed when this line drops.

↪ Inactivity Timeout Default: 30

Here you can specify the value for a timer. When the specified time expires, the Com-Server port closes the connection. The timer is reset if there is an active network connection when data are being exchanged. If no data are set within the specified time, the Com-Server port closes the connection to the TCP server. *InactivityTimeout* = 0 deactivates the connection closing after a timeout.

1 tick: 1 second
Format: decimal

↳ **Disconnect Char**
Default: 0

If the Com-Server receives the character defined here at the serial port, the connection to the TCP server is closed. The character itself is not sent to the TCP server. Default value is 0 (=deactivated).

Format: decimal

↳ **Connection Timeout**
Default: 300

This value is a connection timeout that is only effective together with an activated *Inactivity Timeout*. After the *Inactivity Timeout* expires, the Com-Server tries to send any still existing, unsent user data for the duration of the Connection Timeout. If it receives no reply from the TCP server within this time, you may assume the connection is „hanging“; the data are then rejected and the connection reset. To prevent unintended loss of data, make this value sufficiently large. Connection Timeout = 0 deactivates re-setting of the connection after a timeout.

1 tick: 1 Second

Format: decimal

12.1.2 TCP client mode with serial addressing



In this mode the address data for the server are not permanently configured, but rather transmitted serially to the Com-Server as an ASCII string in front of the actual data. This makes it possible to open connections to changing TCP servers.

↳ **Client: „C“+Addr**
Default: deactive

Activating this switch activates the TCP client mode to alternating TCP servers. The address of the TCP server need not be permanently configured, rather it is send as an ASCII string in front on the user data on the serial port. The string for addressing is not included in the send. There are two possibilities for string format:

1. The parameters *Server Port* and *Server IP/URL* are zero.

```
C[IP address or URL],[port number]<CR>
```

Example:

```
C172.16.231.101,4800<CR>
```

```
Cwww.comserver.com,9100<CR>
```

2. The parameter *Server Port* contains the Default Port (e.g. 4800), *Server IP/URL* contains the first three bytes of the IP address (e.g.172.16.231.0).

```
C 4.Byte IP address <CR>
```

(z.B. „C101<CR>“)

 A URL can only be assigned in conjunction with a valid DNS server. The name used is not allowed to contain

space characters (0x20), nor can the first character be a decimal (0x2E). A server IP or URL is deleted by entering 0.0.0.0. For additional information refer to the section Menu: Setup SYSTEM → Setup TCP/IP → DNS-Server.

Opening the TCP connection

If serial addressing is used, the Com-Server waits to receive a valid address string. Any data arriving prior to receipt of a valid addressing are rejected.

Closing the TCP connection

As with using fixed destination parameters, the connection can be closed using the options *Inactivity Timeout* and *Disconnect Char*.

12.1.3 Optional settings

Using the following optional settings in the submenu *...TCP Client* → *Special Options* various special functions can be activated and deactivated. These apply both for operation with fixed or serial addressing.

Response Mode (Default: deaktiv)

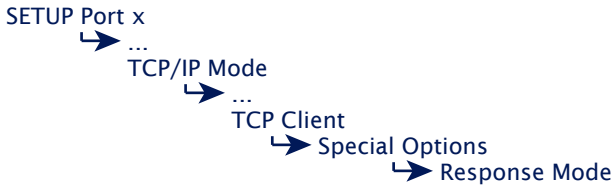

In *Response Mode* the application is informed of the network-side connection status of the Com-Server in the serial terminal device by the output of special characters. This function is only available in TCP client mode.

The following messages are output on the serial port:

C (connected)

The connection was successfully opened. There is a TCP connection to the server.

N (not connected)

The connection was not successfully opened. There is no response from the TCP server.

D (disconnected)

The connection attempt was rejected by the TCP server, or a previously existing connection was normally closed by the TCP server or Com-Server.

lxxx.xxx.xxx.xxx (invoked by ...)

A client application on the indicated station successfully opened a TCP connection to the Com-Server (e.g. 172.20.20.1).

Serial transmission parameters

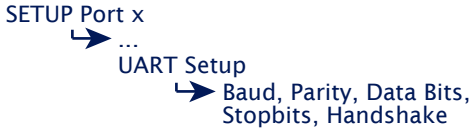

Baud rate, data bits, parity and handshake procedure must conform to the connected serial device. For details see section *Configuration of the Serial Port*.

Serial receive buffer



The Com-Server has a variable serial receive buffer of approx. 4kB. The menu item allows this value to be reduced. Whether the serial receive buffer is automatically cleared when a connection is opened or any existing older data are sent to the application is determined by the Flush Buffer option. Details can be found in the section *Basic configuration of the Com-Server*.

Packeting options for serial receive data

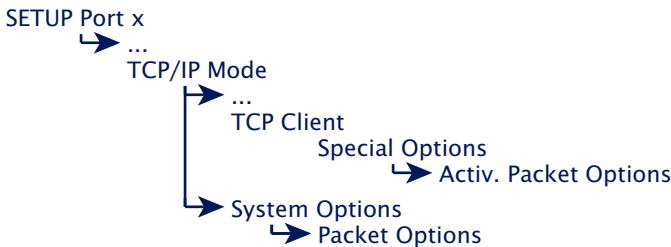

When sending serial protocols such as Modbus/RTU, it is often necessary to send serial received datagrams also closed on the network side in a TCP packet. The menu paths shown above offer various ways to parameterize serial packet limits (pause times, start-/end sequences, datagram lengths) and to

activate their processing for the respective mode. Details can be found in the section *Packeting of serial datagrams*.

Network Delay

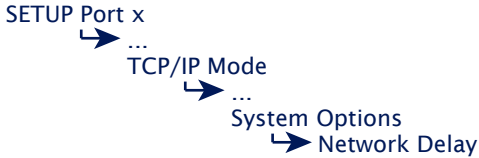

In its default setting the Com-Server attempts to send the serially arriving data to the network-side application with as little delay as possible. Particularly when working with host serial protocols it may be necessary to send the protocol blocks enclosed in a network packet if possible. The option *Network Delay* in *Setup Setup Port x* → *Setup TCP/IP* → *System Options* allows an artificial delay in transmission for this purpose. Details can be found in section *Menu ... Setup TCP/IP* → *System Options*.

Keep Alive Time



The factory default setting for the keep-alive check is 30 seconds. I.e. if there is no data traffic the Com-Server checks during the set time interval to see whether the connected network application can be reached. If there is no reply, for example due to a break in the network infrastructure, the Com-Server resets the connection internally and thus enables a new connection to be opened. Details can be found in section *Menu SETUP System* → *Setup TCP/IP*.

12.1.4 Deactivating TCP client mode

Set the following parameters in the menu branch *SETUP Port x* → *TCP/IP Mode* → *TCP Client* to a value of 0 and save this change:

... → *Server Port*

... → *Special Options* → *Client: „C“+Addr*

Alternately you may use the function *SETUP Port x* → *Port State* → *Clear Port Mode*. The Connection State in the Submenu *SETUP Port x* → *Port State* must then be named *FREE*.

12.1.5 Application:

Client/Server mode between Com-Server-Ports

There are various ways of connecting two or more Com-Server ports together in this mode. All involved Com-Server ports must be configured for TCP client mode and may then alternately connect to each other when there are data on the serial port. After the data has been send the connection is closed either by the *Inactivity Timeout* or the *Disconnect Character*.

When the clients have changing IP addresses, for example in the case of connections via DSL routers with NAT, alternating operation of the Com-Servers in TCP client mode can also be used as an alternative to Box-to-Box mode. Under *Server IP/URL* the host name of the counterpart is used instead of the numerical IP address. In this case the Com-Server obtains the current IP address first via DNS before the TCP connection is opened. Updating of the DNS system when there is an IP address change must be done by the DSL router itself or by another component with appropriate client service (e.g. DynDNS).

Serial addressing (Parameter *Client: „C“+Addr*) also makes changing connections between multiple Com-Server ports possible. In this case the addressing must be generated by the serial devices.

Example 1: A control program polls a measuring device; the measuring device is passive

Configuration menu:

- TCP/IP Mode – TCP-Client

Com-Server A

- Server Port: 8000
- Server IP: IP address Com-Server B
- Client“C”+Addr.: deactive

Com-Server B

- Server Port: 0000
- Server IP: 0.0.0.0
- Client“C”+Addr.: deactive

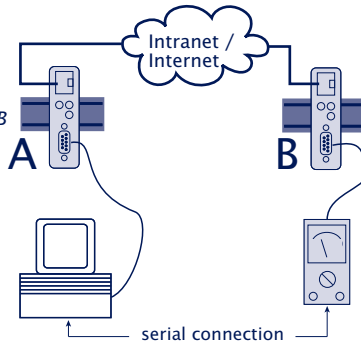

Example 2: A control program polls a measuring device; the measuring device can actively send data to the control program

Configuration menu:

- TCP/IP Mode – TCP-Client

Com-Server A

- Server Port: 8000
- Server IP: IP address Com-Server B
- Client“C”+Addr.: deactive

Com-Server B

- Server Port: 8000
- Server IP: IP address Com-Server A
- Client“C”+Addr.: deactive

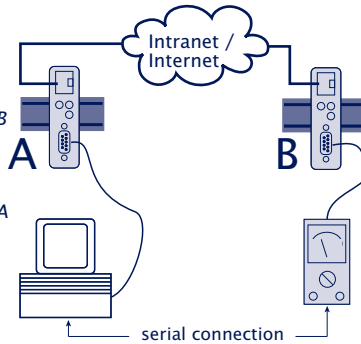

Example 3: A control program polls multiple measuring devices; the measuring devices can (e.g. in case of error) independently send data to the control program

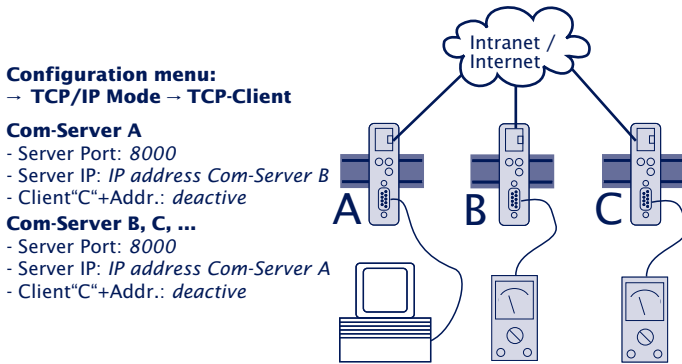

Configuration menu:
→ TCP/IP Mode → TCP-Client

Com-Server A

- Server Port: 8000
- Server IP: IP address Com-Server B
- Client"C"+Addr.: deactivate

Com-Server B, C, ...

- Server Port: 8000
- Server IP: IP address Com-Server A
- Client"C"+Addr.: deactivate

The control program addresses the measuring devices through the serial port in the following format:

C[IP address],[port number]<CR>

Example:

C172.10.230.10,8000<CR>

13 Data transfer per UDP

Instead of TCP, communication with the serially connected devices can also take place via UDP. This method offers several advantages over TCP when the data are secured already within a serial protocol in creating your own software.

■ The Com-Server as UDP client

13.1 Der Com-Server als UDP-Peer

UDP is a connection-less and unsecured datagram service. During data transmission there is no fixed connection between the communicating network stations. Datagrams are addressed to the destination in the network without there being any reply referencing the success or failure of the sending. Any repetition of lost data packets is solely the responsibility of higher level protocols.

Data direction network – serial

Due to the connectionless functionality of UDP the Com-Server port must always be configured for data exchange using UDP datagrams. This can be accomplished either by setting up a static destination host or by activating serial addressing using the option Client:“C“+address.

If the Com-Server is configured in this way as a UDP client, all UDP datagrams which are addressed to the configured local port number are accepted. The data range of the UDP protocol is send transparent to the serially connected device.

Data direction serial – network

There are two ways to specify the network destination for received serial data. One is static using the menu items ...UDP Client r Server Port and Server IP/URL. Alternately the option Client:“C“+Addr. can be enabled, whereby the destination parameter IP address and JURL and port number are expected in the serial data stream before the actual user data.

Packeting of the serial data into corresponding UDP datagrams can be affected using the various functions of Packet Options.

13.1.1 Setting the local UDP port number

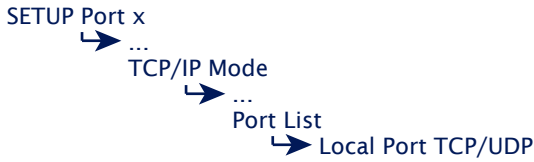

To send a UDP datagram to the Com-Server, the sender needs the IP address of the Com-Server as well as its UDP port number on which the data are received. Access to the serial port on the Com-Server per UDP takes place through the port specified in the above menu branch. The factory default setting is 8000.

The Com must be prepared for receiving UDP datagrams by specifying static destination parameters or by enabling serial addressing in the menu path UDP Client.

The entire data range of received UDP packets is sent transparent to the serially connected device.

13.1.2 UDP clientmode with fixed destination system

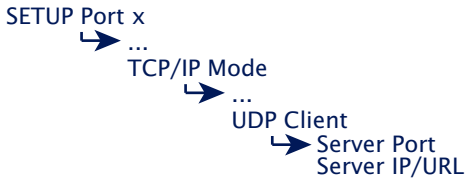

↳ **Server Port**

Port number that the application (TCP server process) addresses on the computer.

Format: decimal

↳ **Server IP/URL**

IP address or URL of the computer on which your application (TCP server process) is active.

Format: Dot notation or URL

i A URL can only be assigned in conjunction with a valid DNS server. The name used is not allowed to contain space characters (0x20), nor can the first character be a decimal (0x2E). A server IP or URL is deleted by entering 0.0.0.0. For additional information refer to the section Menu: Setup SYSTEM → Setup TCP/IP → DNS-Server.

All incoming serial data are sent to the configured destination system in UDP datagrams. Without using *Packet Options* you cannot affect the network-side division of the data into UDP datagrams. To ensure that serially associated data blocks are also sent closed in a UDP datagram, *Packet Options* offers possibilities for parameterizing serial packet limits (pause times, start-/end sequences, lengths). For details, see the section *Packetizing serial datagrams*.

13.1.3 UDP client mode serial addressing

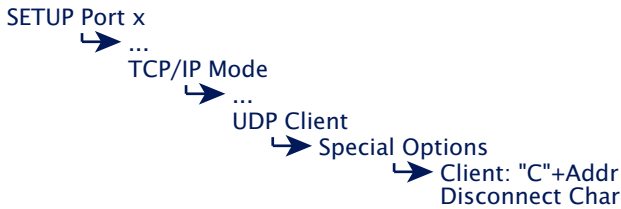

In this mode the address data of the destination system are not permanently configured, but rather sent serially to the Com-Server as an ASCII string before the actual user data. This makes it possible to make connections to changing UDP servers.

↳ **Client: „C“+Addr** **Default: deactivate**

Activating this switch activates UDP client mode to alternating UDP peers. The address of the UDP peer need not be permanently configured, rather it is send as an ASCII string in front on the user data on the serial port. The string for addressing is not included in the send. There are two possibilities for string format:

1. The parameters *Server Port* and *Server IP/URL* are zero.

```
C [IP address or URL], [port number] <CR>
```

Example:

```
C 172.16.231.101, 4800 <CR>
```

```
C www.comserver.com, 9100 <CR>
```

2. The parameter *Server Port* contains the Default Port (e.g. 4800), *Server IP/URL* contains the first three bytes of the IP address (e.g. 172.16.231.0).

```
C 4.Byte IP address <CR>
```

(e.g. „C101<CR>“)

i A URL can only be assigned in conjunction with a valid DNS server. The name used is not allowed to contain space characters (0x20), nor can the first character be a decimal (0x2E). A server IP or URL is deleted by entering

0.0.0.0. For additional information refer to the section
Menu: Setup SYSTEM → Setup TCP/IP → DNS-Server.

↪ **Disconnect Char**
Default: 0

This parameter is only processed if the parameter *Client:*
„C“+Addr is activated. If the Com-Server receives the character configured here at its serial port, it deletes the last serially received UDP server address. The character itself is not sent. The preset value is 0.

13.1.4 Optional settings

The following optional settings allow you to activate and deactivate various special functions. These apply to fixed as well as serial addressing.

Special Options → Write „C“+Addr (Default: deactive)

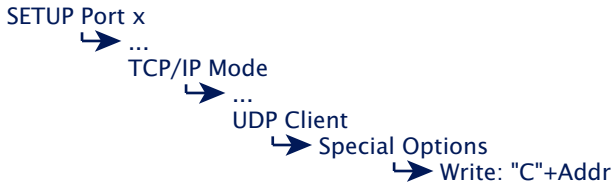

Set this switch to active (1) to output the sender address in ASCII format before outputting the data for a UDP datagram to the serial port. The string always contains 22 characters.

```
C IP-Adresse, Portnummer (z.B. „C172.016.231.101,04800“)
```

Serial transmission parameters



Baud rate, data bits, parity and handshake procedure must conform to the connected serial device. For details see section *Configuration of the Serial Port*.

Packeting options for serial receive data

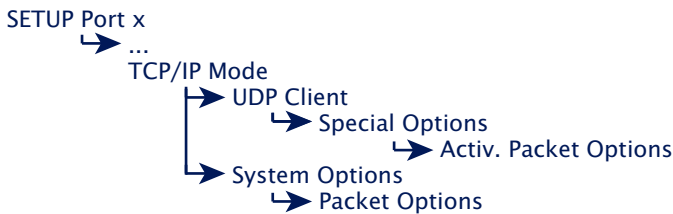

When sending serial protocols such as Modbus/RTU, it is often necessary to send serial received datagrams also closed on the network side in a TCP packet. The menu paths shown above offer various ways to parameterize serial packet limits (pause times, start-/end sequences, datagram lengths) and to activate their processing for the respective mode. Details can be found in the section *Packeting of serial datagrams*.

13.1.5 Deactivating UDP mode

Set the following parameters in the menu branch *SETUP Port x* → *TCP/IP Mode* → *UDP Client* to a value of 0 and save this change:

... → *Server Port*

... → *Special Options* → *Client: „C“+Addr*

Alternately you may use the function *SETUP Port x* → *Port State* → *Clear Port Mode*. The Connection State in the Submenu *SETUP Port x* → *Port State* must then be named *FREE*.

14 UDP Bus Mode

UDP Bus Mode projects the behavior of an RS485 bus with master/slave protocol on to the network. Polling of the serial master is sent via broadcast to the Com-Server which is configured as a slave. The reply from the contacted slave is then addressed or likewise sent back to the master in a broadcast.

- Configuration of the bus master
- Configuration of the bus slave(s)
- Replacement for IP-Bus-Mode

14.1 Function of UDP Bus Mode

The Com-Server configured in UDP Bus Mode as a master sends all received serial data as a broadcast into the network to the configured UDP port. All slave Com-Servers active on the addressed UDP port receive these data and forward them to their serial devices with no content changes. The devices addressed in the course of this protocol will then formulate and send their reply.

In the opposite direction from the slave(s) to the master, network transmission can be directly addressed. If the reply from a particular serial device also needs to be visible to all other slaves, this data direction also needs to be handled as a broadcast.

When using UDP Bus Mode the following prerequisites and peculiarities need to be taken into account:

- UDP Bus Mode replaces the *IP Bus Mode* of previous Com-Server generations. The modes are however not mutually compatible, so that no mixed installations are possible.
- The serial devices must send their data with their own security protocol. Since the Com-Servers use connection-less and unsecured UDP as the network protocol, they cannot provide data security.
- Since transmission is via broadcast in at least one direction, all devices which form a UDP bus belong to the same subnet. This means the subnet mask and the network section of the IP address must be identical in all Com-Servers. Cross-network communication using routers is not possible.

14.1.1 Configuring the local port number

A UDP port number must be set on both the master as well as the slave Com-Servers. The contents of all UDP datagrams addressed to the Com-Server and this UDP port number are received and their data forwarded to the serial device.

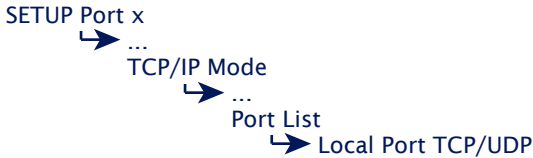

14.1.2 Configuring the destination parameters

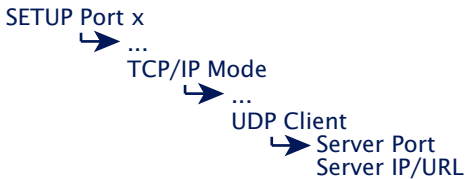

Configuration on the UDP bus master

↳ **Server port**

Port number that was configured as a local port number for the UDP Bus slaves.

Format: decimal

↳ **Server IP/URL**

To ensure sending of the UDP datagrams as broadcasts, configure the broadcast address 255.255.255.255 here.

Configuration on the UDP bus slave

↳ **Server port**

Port number that was configured as a local port number for the UDP Bus master.

Format: decimal

↳ **Server IP/URL**

If the UDP datagrams need to be sent addressed to the UDP Bus master, enter here the IP address of the UDP Bus master. TO also send in this direction via broadcast, configure here broadcast address 255.255.255.255.

14.1.3 Optional settings

Serial transmission parameters



Baud rate, data bits, parity and handshake procedure must conform to the connected serial device. For details see section *Configuration of the Serial Port*.

Packeting options for serial receive data

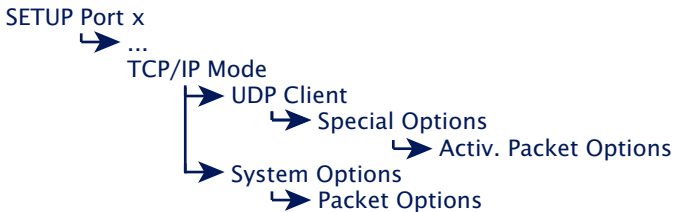

When sending serial protocols such as Modbus/RTU, it is often necessary to send serial received datagrams also closed on the network side in a TCP packet. The menu paths shown above offer various ways to parameterize serial packet limits (pause times, start-/end sequences, datagram lengths) and to activate their processing for the respective mode. Details can be found in the section *Packeting of serial datagrams*.

14.1.4 Deactivating UDP mode

Set the following parameters in the menu branch *SETUP Port x* → *TCP/IP Mode* → *UDP Client* to a value of 0 and save this change:

... → *Server Port*

... → *Special Options* → *Client: „C“+Addr*

Alternately you may use the function *SETUP Port x* → *Port State* → *Clear Port Mode*. The Connection State in the Submenu *SETUP Port x* → *Port State* must then be named *FREE*.

15 The Windows COM port redirector

With the COM Port Redirector available for Windows XP, Vista, 7, 8, 8.1, 10 (incl. 64-bit and server editions) the virtual COM ports are installed in the respective system. These behave in a serial application exactly like normal local ports, but are actually located on Com-Servers located in the network. In this way serially communicating programs can profit from the advantages of network transmission without changing a single line of program code.

- Download and installation of the COM redirector
- Configuration of the COM port redirector
- TCP ports used

15.1 Overview

The W&T COM Port Redirectors implemented as Windows core drivers provide virtual COM ports which behave like local standard ports with respect to opening applications.

There are two variants of the COM redirector available:

- COM Redirector Legacy
- COM Redirector PnP

The difference is the implementation of the core driver. Although legacy ports are full Windows resources, they are not displayed by the Windows Device Manager responsible for the plug-and-play system. In connection with serial applications, which take available COM ports exclusively from the Device Manager, the PnP version must therefore be installed.

Configuration is registry-based using the COM Port Redirector configuration tool from the Windows start menu.

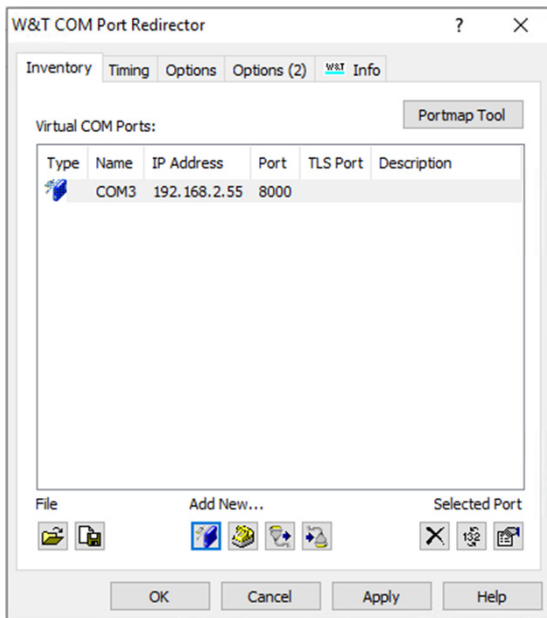

 *The following sections describe a quick start-up which is sufficient for many applications. More detailed information for all configuration options for the W&T Com Port Redirector can be found in the online help.*

15.2 Download & installation of the W&T COM redirector

The latest version of the COM Port Redirector as well as additional tools, application descriptions and FAQs can always be downloaded from our Web site <http://www.wut.de>. The simplest way to navigate from there is by using the menu tree on the left side of the page. Follow the

Downloads → Com-Servers

path to get to the website containing a direct link to the COM Port Redirector.

Use of the *W&T COM Port Redirector* in connection with Com-Servers is free and not subject to any licensing requirements.

15.2.1 Installation of the W&T COM port redirector

System requirements for installing the W&T Com Port Redirector:

- Operating system Windows XP, Vista, Win 7, 8, 8.1, 10 (including all Server and 64Bit editions)
- Login as administrator or with administrator rights

 *Installation of the W&T Com Port Redirector is done as an update to any already existing older versions. All settings and connection parameters are saved and remain available unchanged. To prevent restarting of the computer when your are finished, quit all applications and services which are actively accessing COM ports before performing the update.*

After downloading and unpacking the archive, start the MSI or exe file to start installation. In addition to setting up the core driver, a link to the configuration tool in the Windows Start menu under *W&T COM Port Redirector* is created.

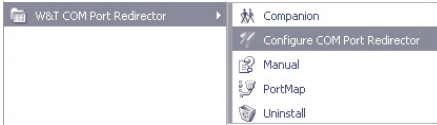

15.2.2 Uninstalling the W&T COM Port Redirector

The W&T COM Port Redirector is uninstalled using Windows software administration. Start the Software applet in the control panel and there select the entry *W&T COM Port Redirector*. Clicking on the *Remove* button removes the COM Port Redirector from the system.

15.3 Set up virtual COM ports

To set up a new virtual COM port, start the COM Port Redirector configuration applet in the control panel and click on the Com-Server button. A dialog box opens which you fill in and then click on OK. All settings can also be corrected later by editing the corresponding entry in the port list. Once all your entries have been made, click on OK. It is not normally necessary to restart Windows in order to use the new COM port.

TCP-Port

The entry field *TCP Port* in the dialog box contains the TCP port used for transporting the serial user data. To communicate with a Port A of a Com-Server configured with the factory default settings, you must use the pre-configured value 8000. For ports B and C of a Com-Server with the factory default settings 8100 and 8200 must be used.

In addition to the indicated TCP port for user data transport, the COM Port Redirector uses an additional TCP connection for exchanging configuration and status information. The port number used for this is always calculated from the formula *data port* + 1094 (e.g. 8000 + 1094 = 9094). If – for example when a firewall is present – you need to deviate from the prescribed TCP port, the TCP ports entered in the COM Port Redirector must also be set correspondingly in the Com-Server:

15.3.1 Optional settings on the Com-Server

By default the Com-Server is in TCP Server mode, so that for use with the COM Port Redirector you must first configure only the network-specific basic parameters IP address, subnet mask and gateway address. It is not necessary to set serial transmission parameters (e.g. baud rate), since these are de-

terminated by the serial application and automatically set in the Com-Server by the COM Port Redirector.

Local Port and Control Port



If a TCP port which differs from the factory default setting was entered in the *COM Port Redirector*, the corresponding values must also be configured in the above menu paths of the Com-Server. The Control Port Number used by the COM Port Redirector is always calculated using the formula Data Port + 1094.

Packeting options for serial receive data

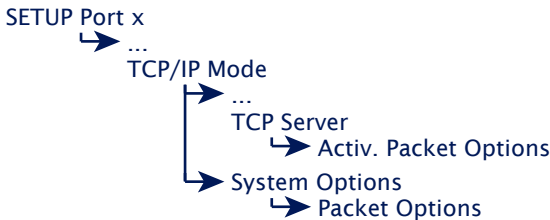

When sending serial protocols such as Modbus/RTU, it is often necessary to send serial received datagrams also closed on the network side in a TCP packet. The menu paths shown above offer various ways to parameterize serial packet limits (pause times, start-/end sequences, datagram lengths) and to activate their processing for the respective mode. Details can be found in the section *Packeting of serial datagrams*.

Network Delay

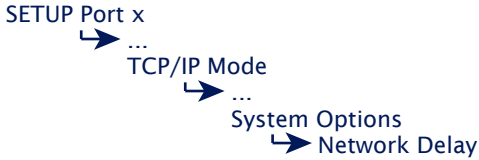

In its default setting the Com-Server attempts to send the serially arriving data to the network-side application with as little delay as possible. Particularly when working with host serial protocols it may be necessary to send the protocol blocks enclosed in a network packet if possible. The option *Network Delay* in *Setup Setup Port x* → *Setup TCP/IP* → *System Options* allows an artificial delay in transmission for this purpose. Details can be found in section *Menu ... Setup TCP/IP* → *System Options*.

Keep Alive Time

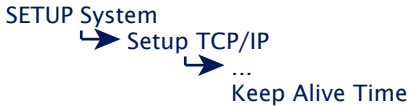

The factory default setting for the keep-alive check is 30 seconds. I.e. if there is no data traffic the Com-Server checks during the set time interval to see whether the connected network application can be reached. If there is no reply, for example due to a break in the network infrastructure, the Com-Server resets the connection internally and thus enables a new connection to be opened. Details can be found in section *Menu SETUP System* → *Setup TCP/IP*.

16 Box-to-Box mode

In „Box to Box“ mode any two Com-Server serial ports can be logically linked to each other over the network. The two connected serial terminal devices are in constant online contact in this mode. Optionally communication can be encrypted via TLS/SSL for protected transmission of the serial data in the network.

- Typical applications
- Configuration of Box-to-Box connections
- Activation of TLS/SSL protected transmission.

16.1 Box-to-Box application

This mode is based on a permanent TCP connection between two serial ports on Com-Servers distributed in the network. One of these ports acts as the master, the other as slave, though from the view of the serial data it makes no difference which device is acting as master or slave. The master port functions as a TCP client and is thereby responsible for opening (after configuration or reset) and closing (after deactivating *Box-to-Box* mode).

On the network side, Box-to-Box mode only exchanges data when there are serial user data present. As long as the keep-alive check is deactivated in the Com-Servers, there is no acknowledgement traffic beyond the TCP protocol. (see *chapter Menu SETUP System → Setup TCP/IP*). Optionally the network-side connection can be encrypted via TLS.

As a consequence of the permanent connection, both Com-Servers in a Box-to-Box connection must have fixed IP addresses. It is not possible to operate using host names and URLs with the Com-Server LC. If this is necessary – such as in conjunction with DSL connections – the TCP client mode can be replaced with COM-Servers of the Highspeed generation.

Typical applications

- Replacing complex serial star topology wiring, such as in small business systems
- Serial connections over longer distances. A pair of Com-Servers replaces two line drivers and offers in addition error correction using the Ethernet transmission procedure.
- Serial remote connection using already existing Ethernet-Internetwork connections (routers, bridges, etc.). Confidentiality of the data can be secured on the network side through optional use of TLS/SSL.
- Implementing serial connections with frequently changing operating sites without additional cable expenditure - simply plug into the Ethernet cable!

16.1.1 Configuring Box-to-Box mode

 Only the Master port is configured for „Box to Box“ mode; Slave ID address, slave port number as well as any use of TLS encryption are configured only on the master port! Settings in the Special Options submenu and parameterizing of the serial port can and must be done on both ports (see examples at the end of this section).

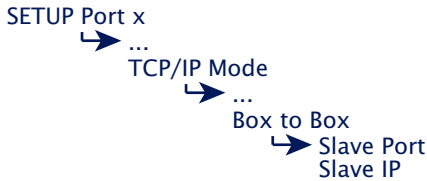

↪ **Slave Port** (set only for master port)

Port of the serial Com-Server Slave port. The following port numbers are pre-configured at the factory:

- Port A = 8000 (all models with only one serial port)
- Port B = 8100
- Port C = 8200
- Port D = 8300

↪ **Slave IP-Address** (set only for master port)

IP address of the Com-Server in which the Slave port is located.

Once you have entered all the parameters in the Com-Server port menu, press the *ENTER* key several times to return to the main menu and save the entries with *SAVE Setup*. The message *Saving...* appears, then *Box to Box* mode is activated. The entry *Box to Box Master* now appears in the *SETUP Port x* → *Port State* → *Connection State* menu. The connection status can be read at any time in this menu both for the Master and for the Slave port. In addition, both Status LEDs for the respective Com-Server ports begin to flash cyclically at approximately 1x a second.

16.1.2 Optional settings

The following optional settings allow enabling/disabling various special functions. With the exception of TLS(SSL) encryption these can be set independently of each other on either the master or the slave.

Serial transmission parameters

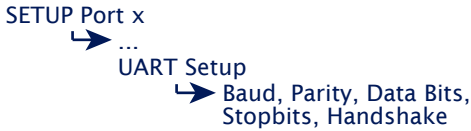

Baud rate, data bits, parity and handshake procedure must conform to the connected serial device. For details see section *Configuration of the Serial Port*.

Serial receive buffer

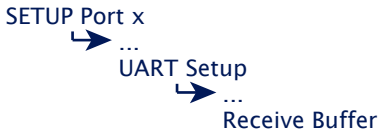

The Com-Server has a variable serial receive buffer of approx. 4kB. The menu item allows this value to be reduced. Whether the serial receive buffer is automatically cleared when a connection is opened or any existing older data are sent to the application is determined by the Flush Buffer option. Details can be found in the section *Basic configuration of the Com-Server*.

TLS (SSL) Encryption

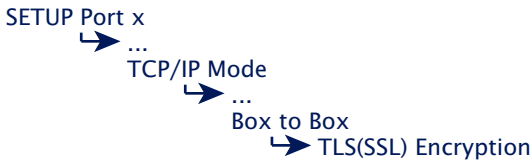

The TCP connection between Box-to-Box master and slave is TLS/SSL encrypted. When sending time-critical serial protocols

the slightly increased latencies caused by the TLS protocol may need to be taken into account.

Packeting options for serial receive data

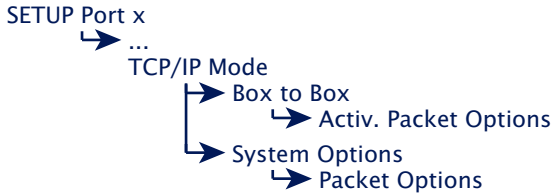

When sending serial protocols such as Modbus/RTU, it is often necessary to send serial received datagrams also closed on the network side in a TCP packet. The menu paths shown above offer various ways to parameterize serial packet limits (pause times, start-/end sequences, datagram lengths) and to activate their processing for the respective mode. Details can be found in the section *Packeting of serial datagrams*.

Network Delay

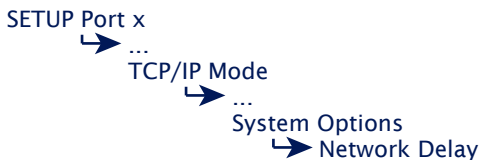

In its default setting the Com-Server attempts to send the serially arriving data to the network-side application with as little delay as possible. Particularly when working with host serial protocols it may be necessary to send the protocol blocks enclosed in a network packet if possible. The option *Network Delay* in *Setup Setup Port x* → *Setup TCP/IP* → *System Options* allows an artificial delay in transmission for this purpose. Details can be found in section *Menu ... Setup TCP/IP* → *System Options*.

16.1.3 Deactivating Box to Box Mode

As with setting up the Box-to-Box connection, proper disabling of this mode is also done using the Box-to-Box master. Set the following parameters in the menu path *SETUP Port x* → *TCP/IP Mode* → *Box to Box* to a value of 0 and save this change:

... → *Slave Port*

Without the associated Box-to-Box-Master Box-to-Box-Slave mode can only be quit using *SETUP Port x* → *Port State* → *Clear Port Mode*.

The Connection State in the sub-menu *SETUP Port x* → *Port State* must then be *FREE*.

15.1.4 Sample configurations for Box to Box mode

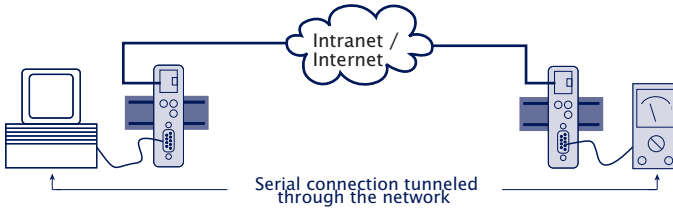

Box-to-Box Master

IP address: 172.16.231.8
Port number of Port A: 8000

```
SETUP Port 0
├── TCP/IP Mode
│   └── Box to Box
│       ├── Slave Port
│       │   └── 8000
│       └── Slave IP address
│           └── 172.016.231.005
└── UART Setup
    ├── Baud    --> ...
    ├── Parity  --> ...
    ├── Data Bits --> ...
    ├── Stopbit --> ...
    └── Handshake --> ...
```

Box-to-Box Slave

IP address: 172.16.231.5
Port number of Port A: 8000

```
SETUP Port 0
├── TCP/IP Mode
└── UART Setup
    ├── Baud    --> ...
    ├── Parity  --> ...
    ├── Data Bits --> ...
    ├── Stopbit --> ...
    └── Handshake --> ...
```

The address parameters of the slave as well as any activation of TLS encryption are configured only on the master Com-Server. The serial transmission parameters (baud rate, data bits etc.) and the optional use of the packet options must on the other hand be set in both Com-Servers to conform with the connected devices.

17 Mode FTP-Server

The FTP, which is based on TCP, is a standard protocol for file transmission. In the mode as FTP server an FTP client can send files to the Com-Server whose contents are sent to the serially connected device. In the other direction, serial data arriving at the Com-Server from the FTP client can be written to a file.

■ The Com-Server as FTP server

17.1 The Com-Server as FTP server

This mode can be used when the send data are in file format and the action will always be started from your TCP/IP computer.

If the FTP-Server service is enabled in the Com-Server, connections to configured port numbers are accepted by FTP clients. Using the example of the destination-oriented FTP client always included with Windows the invoking looks like this:

```
ftp [IP-Number] oder ftp [Host name]
```

After entering the FTP command you can acknowledge the polling of the login name using ENTER.

17.1.1 Activating FTP-Server mode

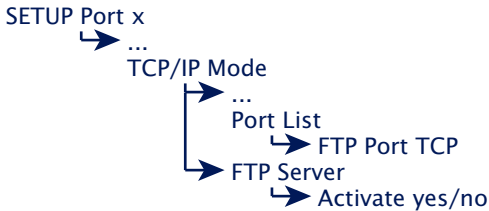

↳ FTP Port TCP

Decimal port number at which the FTP-Server service of the Com-Server is reached. The factory default setting is 21.

↳ Activate yes/no

Activating the service on the port number configured in the Port List. The Com-Server only accepts connections if the FTP-Service is enabled in this menu branch.

17.1.2 Supported FTP commands and functions

The Com-Server accepts the following FTP commands:

↪ PUT [*local file*] [*remote file*]

Sending the file *local file* to the Com-Server for the purpose of outputting on the serial port. Since no *remote file* exists, enter any character here for this.

↪ GET [*remote file*] [*local file*]

Reading characters from the RS232 in *local file*. For *remote file* enter any desired letter, or encode a time-based termination criterion for data transfer. A maximum 3-digit number can be entered for this purpose, whereby one tick equals one second. If *remote file* does not contain a value in the valid range, the *GET* command is ended 30 seconds after the last read character.

Example:

The command *GET 5 /user/cs_in* writes all data serially received by the Com-Server to the file *cs_in* in the */user* directory. If a pause of at least 5s occurs in the serial data stream, the Com-Server ends the *GET* command.

Details on invoking commands in the respective FTP client software can be found in their documentation.

↪ ASCII

Transmission in ASCII mode

↪ IMAGE

Transmission in binary mode

↪ QUIT

Ends the FTP session

17.1.3 Optional settings

Serial transmission parameters

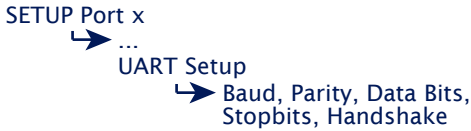

Baud rate, data bits, parity and handshake procedure must conform to the connected serial device. For details see section *Configuration of the Serial Port*.

Keep Alive-Time

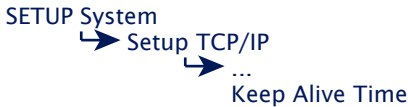

The factory default setting for the keep-alive check is 30 seconds. I.e. if there is no data traffic the Com-Server checks during the set time interval to see whether the connected network application can be reached. If there is no reply, for example due to a break in the network infrastructure, the Com-Server resets the connection internally and thus enables a new connection to be opened. Details can be found in section *Menu SETUP System → Setup TCP/IP*.

Flush Buffer

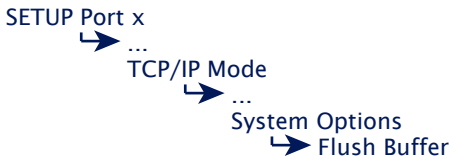

This option determines whether when a network-side connection is opened to the Com-Server the serial receive buffer is cleared (Flush Buffer = 1) or any existing data are sent to the client application (Flush Buffer = 0). Details can be found in the section *Basic configuration of the Com-Server*.

18 Mode FTP-Client

FTP, which depends on TCP, is a complete, session-oriented, general purpose file transfer protocol. If the Com-Server is configured as an FTP client, the connection to an FTP server is automatically opened, triggered by serial data reception. It is possible both to automatically write serial data to files and to open files from the FTP server for serial outputting.

- Configuration of the Com-Server as FTP client
- Application examples for FTP-Client mode

18.1 The Com-Server as FTP client

This mode enables automated writing and reading of files to and from any standard FTP server. The *IP address/URL* of the FTP server are permanently stored in the setup of the Com-Server. Two different methods are available for handling the login procedure and control commands. Either all the information such as user name, password, file command etc. are permanently stored in the setup of the Com-Server, or they are sent serially using a special control string in front of the actual user data.

Application examples for FTP-Client mode

- Automated and paperless archiving of errors, status- and fault messages for any devices. Sporadically or only occasionally occurring messages can be stored in a file using standard software.
- Embedded systems with a serial interface use simple ASCII commands to get access to higher level file systems.

18.1.1 Configuring the destination address and port no.

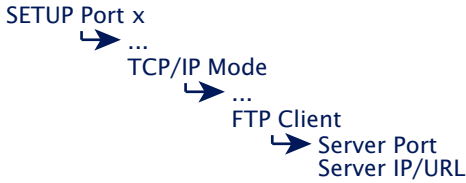

Regardless of whether the FTP protocol is handled automatically or with the help of the serial protocol string, the address data for the respective FTP server must be configured in this submenu.

↳ **Server Port**

Port number that the FTP server addresses (Standard-FTP-Port: 21)

Format: decimal

↳ **Server IP/URL**

IP address or URL of the TCP/IP computer on which the FTP-Server is active.

Format: Dot notation or URL

i A URL can only be assigned in conjunction with a valid DNS server. The name used is not allowed to contain space characters (0x20), nor can the first character be a decimal (0x2E). A server IP or URL is deleted by entering 0.0.0.0. For additional information refer to the section Menu: Setup SYSTEM → Setup TCP/IP → DNS-Server.

18.1.2 The automatic FTP client mode

This mode is recommended whenever you need to execute the same command over and over again. The FTP commands are configured in the Com-Server. The latter opens a connection to the FTP server when it receives data at the serial port. It sends the login and runs the configured file command (getting serial data and saving as a file or reading a file from the FTP server and outputting at the serial port). Closing the FTP session and TCP connection is time-based or optionally by using a reserved character (*Protocol Char*).

Activation and configuration

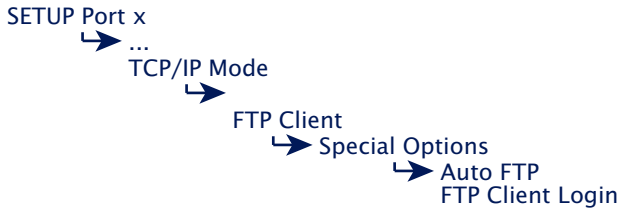

↪ **Auto FTP**

Set this switch to *active* to activate the automatic FTP client.

↪ **FTP Client Login**

Enter the FTP commands one after the other. If a command sequence is already configured, it is displayed when opening the menu and can be overwritten.

↪ Login

Login name for the FTP server

↪ Password

Login password for the FTP server

↪ [TYPE A/TYP E I]

Transmission mode (ASCII/binary). The complete string TYPE A or TYPE I in all caps.

↳ [STOR/APPE/RETR/LIST][*dir/file*]

		Open connection	Close connection
LIST RETR	Directory File	The connection is opened when any character is received at the serial port. This character is not sent.	The connection is closed when the FTP server has sent all data.
APPE STOR	File File	The connection is opened when the first character to be sent is received at the serial port.	The connection is closed when no serial data have arrived during the time period specified under <i>Inactivity Timeout</i> or when the <i>Protocol Char</i> was received.



A maximum of 80 characters are available for all commands! Commands are case sensitive.

Opening the automatic FTP connection

After saving the connection data, the Com-Server waits to receive any serial character. This is the trigger for opening the connection. After successful login on the FTP server using the configured password, the stored command is executed. In the case of *STOR* or *APPE* the connection-triggering character is sent and written to the file.

18.1.3 FTP client with serial protocol

This mode is recommended where constantly changing commands with different files need to be executed.

FTP commands for the FTP client

TYPE	A or I	Activation of ASCII or binary mode
STOR	File	Saves all serially received data in <i>File</i>
APPE	File	Saves all serially received data to the file end of <i>File</i>
RETR	File	Outputs <i>File</i> to the serial port
DELE	File	Deletes <i>File</i>
LIST	Directory	Outputs the directory contents on the serial port
RESET		Generates a software reset of the Com-Server. This command may only be used if there is no active connection to the FTP server

The sequence of the FTP commands is given to the Com-Server port on the serial interface. The Com-Server gets the command sequence, opens the connection to the FTP server and gives an OK to start data transmission.

Activation and configuration

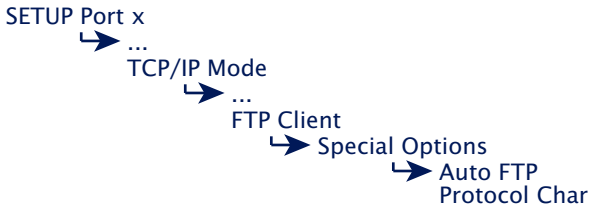

↳ Auto FTP

Set this switch to *deactive* to activate the serial protocol of the FTP-Client

↳ Protocol Char

Default: 0

Choose and enter here a character with which the sequence of FTP commands will be separated from the user data stream. The pre-adjustment is 0. With an ASCII-data transfer (*TYPE A*) the receipt of the protocol character in the data stream causes a shut down of the connection. If

the transmission takes place with *TYPE I* (binary), the occurrence of the protocol character in the data stream will be ignored. The only possibility for a disconnection in this case is by way of an inactivity timeout.

Format: decimal

Opening the FTP connection

After saving the configuration data the Com-Server waits to receive a valid serial login string in the following format.

In serial generation of the login string, the individual commands are separated from each other by a linefeed (0x0a). The character configured under *Protocol Char* must be sent as a terminator. This results in the 3 following formats for the login string:

```
login<0x0a>
password<0x0a>
TYPE I oder TYPE A<0x0a>
STOR, RETR, APPE oder LIST dir/remote file<0x0a>
<Protocol Char>
```

```
login<0x0a>
password<0x0a>
DELE dir/remote file<0x0a>
<Protocol Char>
```

```
RESET<0x0a>
<Protocol Char>
```

i Please note capitalization of the commands. A maximum of 128 characters are available for the complete login string! Specific examples with all the entries needed for receiving and sending a file can be found in the following section Application examples.

18.1.4 Closing the FTP connection

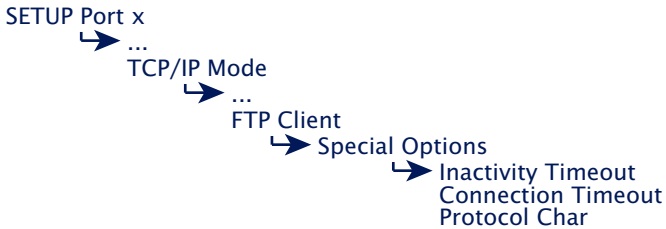

Regardless of whether you are working with Automatic mode or the serial protocol, the FTP connection is closed either time-based or, for ASCII transmission, with the help of the Protocol Chars.

↳ **Inactivity Timeout**

Default: 30s

Configure a timeout in seconds for the FTP commands APPE(nd) and STOR for breaking off the connection. If during the time set here no serial data are received, the FTP client closes the connection to the FTP server. 0 deactivates the timeout and corresponds to a setting of infinite. In this case you must configure the parameter Protocol Char.

Format: decimal

↳ **Protocol Char**

Default: 0

When sending user data in ASCII format (TYPE A) with the STOR or APPE command, reception of the Protocol Char in the user data stream results in stopping data transmission and closing of the network connection. This applies also to the value 0, which results in monitoring of the data traffic for null bytes (0x00). For binary transmissions (TYPE I), the presence of the Protocol Char in the user data stream is ignored. In this case the connection can only be closed via Inactivity Timeout.

Format: decimal

↳ **Connection Timeout** **Default: 300s**

This value is a connection timeout which is only effective together with an activated Inactivity Timeout. After the Inactivity Timeout expires the Com-Server attempts to transmit any existing, unsent serial user data for the duration of the Connection Timeout. If during this time it does not receive any reply from the FTP server, it assumes a hung connection. The data are rejected and the connection reset. To prevent unintended data loss, set this value accordingly high. A value of 0 deactivates the Connection Timeout.

18.1.5 Deactivating FTP client mode

Set the following parameters in the menu branch *SETUP Port x* → *TCP/IP Mode* → *FTP Client* to a value of 0 and save this change:

... → *Server Port*

... → *Server IP/URL*

Alternately you may use the function *SETUP Port x* → *Port State* → *Clear Port Mode*. The Connection State in the Submenu *SETUP Port x* → *Port State* must then be named *FREE*.

18.1.6 Application examples

Example 1:

Opening and closing the connection

1. Send the command string to the serial port. If the complete string was received, the Com-Server begins to open the connection and process the commands.
2. If the functions can be executed one after the other, you get the string *OK + Protocol Char*.
3. Then the actual user data are sent, depending on the command either from the serial port to the network or the reverse.
4. In case of error the FTP server sends the error code + *Protocol Char + Protocol Char*.
5. The connection is automatically closed in either case, and you receive the end code + *Protocol Char* from the FTP server.

Example 2:

User *egon* having the password *happy* wants to output the file */etc/hosts* in ASCII format. The value *003* (Ctrl C) is entered as *Protocol Char*. The protocol would look as follows:

Com-Server	Serial device
	<-----
egon<lf>happy<lf>TYPE A<lf>RETR /etc/hosts<lf><Ctrl C>	
----->	
OK<Ctrl C>	
----->	
[Content of file]<Ctrl C>	
----->	
221 Goodbye<Ctrl C>	

Example 3:

User *egon* having the password *happy* would like to insert binary data to the end of the file */usr/egon/config*. The value *003* (Ctrl C) is entered as *Protocol Char*. The protocol would look as follows:

Com-Server	Serial device
egon<lf>happy<lf>TYPE A<lf>APPE /usr/egon/config<lf><Ctrl C>	<-----
-----> OK<Ctrl C>	
	<----- [binary data]
-----> 221 Goodbye<Ctrl C>	

Example 4:

User *egon* having the password *happy* would like to view the file */usr/private* and transfer the data in ASCII. The file does not exist however. The protocol would look as follows:

Com-Server	Serial device
egon<lf>happy<lf>TYPE A<lf>RETR /usr/private<lf><Ctrl C>	<-----
-----> 550 usr/private: No such file or directory<Ctrl C><Ctrl C>	
-----> 221 Goodbye<Ctrl C>	

19 Mode Telnet Server

Telnet is a terminal emulation protocol. Data transmission is character-oriented. Telnet allows bi-directional character exchange between the TCP/IP computer and the serial terminal device connected to the Com-Server.

■ Com-Server as Telnet server

19.1 The Com-Server as Telnet server

This mode allows character-oriented data to be exchanged between a network side telnet client application and the serially connected device on the Com-Server.

If the telnet server service is activated in the Com-Server, connections from telnet clients are accepted on the configured port number.

19.1.1 Activating Telnet-Server mode

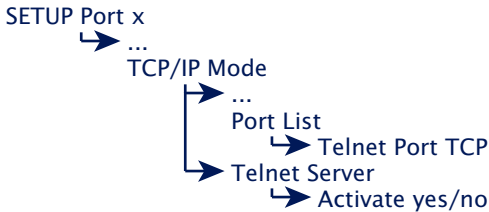

↳ **Telnet Port TCP**

Decimal port number at which the telnet server service can be reached. The factory default setting is 23.

↳ **Activate yes/no**

Activating the service on the port number configured in the Port List. The Com-Server only accepts connections if the telnet service is activated in this menu branch.

19.1.2 Optional Settings

Telnet Echo

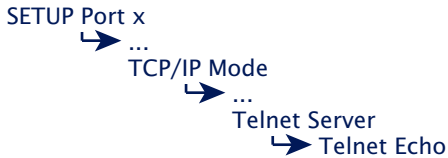

When opening a Telnet session, negotiation between the stations takes place on the network side to determine who will generate the echo of the characters sent by the client. Either the client application generates a local echo, or the Telnet server generates a remote echo by immediately returning all received data. The Telnet echo option on the Com-Server is defined as follows:

Telnet Echo = active (default)

The Com-Server negotiates a remote echo with the client application, and the local echo is turned off. In this case the device serially connected to the Com-Server must generate the echo.

Telnet Echo = disabled

The Com-Server tells the client application when opening the connection that it will not generate an echo, which results there in activation of the local echo. The local echo may have to be manually activated on the Telnet client.

Serial transmission parameters



Baud rate, data bits, parity and handshake procedure must conform to the connected serial device. For details see section *Configuration of the Serial Port*.

Flush Buffer

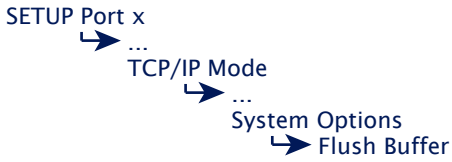

This option determines whether when a network-side connection is opened to the Com-Server the serial receive buffer is cleared (Flush Buffer = 1) or any existing data are sent to the client application (*Flush Buffer* = 0). Details can be found in the section *Basic configuration of the Com-Server*.

20 Mode Telnet Client

Telnet is a protocol for terminal emulation. Data transmission is character-oriented. In Telnet Client mode the Com-Server opens the connection to the configured telnet server starting with the reception of serial data.

■ The Com-Server as Telnet-Client

20.1 The Com-Server as Telnet client

This mode is the simplest way to implement terminal emulation on a serial terminal device and thereby to effect direct communication with the TCP/IP station on which the Telnet server is active. The Com-Server opens the connection as soon as the serial port has received a character.

20.1.1 Destination address and port number

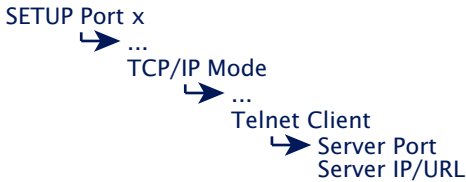

↳ **Server Port (23)**

Port number that the Telnet server addresses (Standard-Telnet-Port: 23)

Format: decimal

↳ **Server IP/URL**

IP address or URL of the TCP/IP computer on which the Telnet-Server is active.

Format: Dot notation or URL

i A URL can only be assigned in conjunction with a valid DNS server. The name used is not allowed to contain space characters (0x20), nor can the first character be a decimal (0x2E). A server IP or URL is deleted by entering 0.0.0.0. For additional information refer to the section Menu: Setup SYSTEM → Setup TCP/IP → DNS-Server.

Opening the Telnet connection

After saving the connection data the Com-Server waits to receive any serial character. This is the trigger for opening the connection.

Closing the Telnet connection

To close the Telnet connection, use the following methods available in the Submenu *...Telnet Client* → *Special Options*.

↳ **Special Options** → **Inactivity Timeout** **Default: 30s**

Here you can specify the value for a timer. When the specified time expires, the Com-Server port closes the connection. The timer is reset if there is an active network connection when data are being exchanged. If no data are set within the specified time, the Com-Server port closes the connection to the TCP server. `InactivityTimeout = 0` deactivates the connection closing after a timeout.

Format: decimal

↳ **Special Options** → **Disconnect Char** **Default: 0**

When the Com-Server port receives the character configured here at its serial port, the Com-Server port closes the connection to the Telnet server. It is important that this value not be used within a Telnet session, since this would result in premature closing. The character itself is not sent. The factory set value is `0`. `Disconnect Char = 0` deactivates this mode

Format: decimal

20.1.2 Optional settings

Serial transmission parameters



Baud rate, data bits, parity and handshake procedure must conform to the connected serial device. For details see section *Configuration of the Serial Port*.

Special Options → Serial 0D->0D00

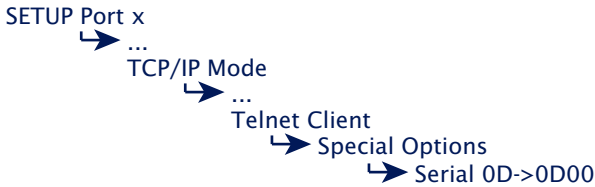

If this switch is activated, an 00H is appended to the serially received character 0DH: in other words, 0DH 00H is sent over the network. This option may have to be activated for sending binary files.

20.1.3 Deactivating Telnet client mode

Set the following parameters in the menu branch *SETUP Port x* → *TCP/IP Mode* → *Telnet Client* to a value of 0 and save this change:

... → *Server Port*

... → *Server IP/URL*

Alternately you may use the function *SETUP Port x* → *Port State* → *Clear Port Mode*. The Connection State in the Submenu *SETUP Port x* → *Port State* must then be named *FREE*.

21 Mode SLIP-Router

SLIP router mode enables serial devices with their own TCP/IP stack to be incorporated into an Ethernet. When the Com-Servers are used in pairs, remote Ethernet segments can also be integrated into the main network in this mode using a serial standard cable.

■ Configuration of SLIP

21.1 SLIP mode

In this mode the Com-Servers functions as a router. All network packets whose destination address is within the configured subnet are routed over the serial interface using SLIP. All arriving serial SLIP packets are passed along to the local Ethernet network.

Application examples for the Com-Server as SLIP-Router

- A Com-Server in SLIP mode can be used as a network interface for devices with their own serial port based TCP/IP stack.
- Connection of two IP/Ethernet networks via serial cable with a maximum distance of 1000m. For this the Com-Servers configured as SLIP routers are used in pairs.

21.1.1 Configuring the SLIP mode

 You may not configure for SLIP routing in the same Telnet session in which the IP address, the subnet mask or the gateway address for the Com-Server was already changed. After you make such settings you must first close the Telnet connection using *q* and then reopen

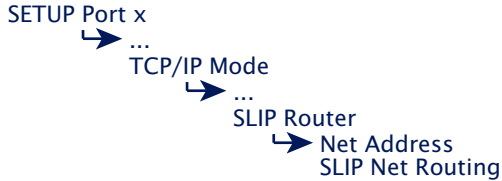

↳ **Net Address**

Enter here the network address of the serially connected subnet you want to route to via SLIP.

↳ **SLIP-Net Routing** **Default: active**

If this parameter has a value of 1, the Com-Server functions as described like a router for the subnet specified under *Net Address*. If the parameter is 0, the Com-Server is transparent, i.e. all packets directed to the IP address of the Com-Server are forwarded as SLIP packets to the serial port. The destination IP address (IP address of the Com-Server) is replaced by the parameter *Net Address*. This allows you to assign individual IP addresses to the connected SLIP computers (=Net Address) without having to assign a separate subnet for each connection.

 Excluded from this procedure are packets for the Telnet configuration port 1111 of the Com-Server!

The following sketch shows the various ways of processing the IP packets depending on the *SLIP-Net Routing* parameter.

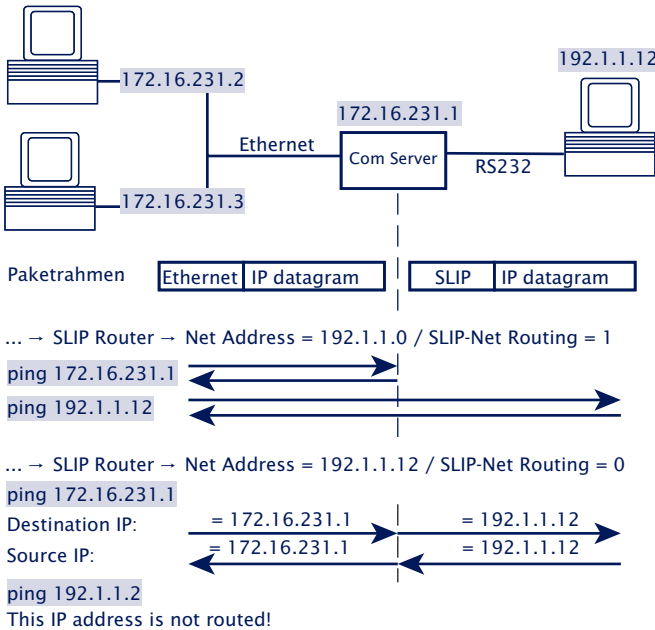

i Access to the network port of a Com-Server functioning as a SLIP router can take place only from a computer located in the same subnet. In the above example, this would mean that access via Telnet, browser or ping to the Com-Server in Ethernet 1 must be made from a computer also located in Ethernet 1.

21.1.2 Optional settings

Serial transmission parameters



When using in pairs, both Com-Servers used as SLIP routers must be configured identically for baud rate, parity, data bits and stop bits.

Software handshake *cannot* be used as serial flow control in SLIP mode, since it cannot be precluded that the *Xon* and *Xoff* characters used for this will not occur within the SLIP packets. Instead, use the hardware handshake settings or – for small data quantities – NO handshake.

More details can be found in the section *Configuration of the Serial Port*.

 *The model Com-Server 20mA 58664 only supports the data channels Rx and Tx. No hardware handshake or other access to the control lines is possible with this model.*

21.1.3 Deactivating SLIP router mode

Set the parameter *Net Address* to zero (0.0.0.0) in the *SETUP Port x → TCP/IP Mode → SLIP Router*, or use the menu *SETUP Port x → Port State → Clear Port Mode*. The Connection State in the Submenu *SETUP Port x → Port State* must then be named *FREE*.

21.1.4 Application example

Connecting two IP networks over serial cable

In SLIP router mode paired use of two Com-Servers allows two IP/Ethernet networks to be connected over a serial RS232/422 cable. The prerequisite is that the two networks must belong to different IP networks.

The gateway in the TCP/IP stacks of the computer must under some conditions be configured to the IP address of the respective Com-Server. If there are additional routers in the network and these are capable of RIP protocol (**R**outing **I**nformation **P**rotocol), the routing will work without explicit configuration of the gateway address.

The serial transmission parameters for both Com-Servers must be identical. Only hardware handshake may be used for flow control. The use of software handshake is not possible due to the *Xon* and *Xoff* characters which the Com-Servers process.

 *The maximum serial transmission speed is 230.400 baud. Transmission of the entire Ethernet-side bandwidth is not possible.*

The following sketch shows a sample configuration for paired use of Com-Servers as SLIP router

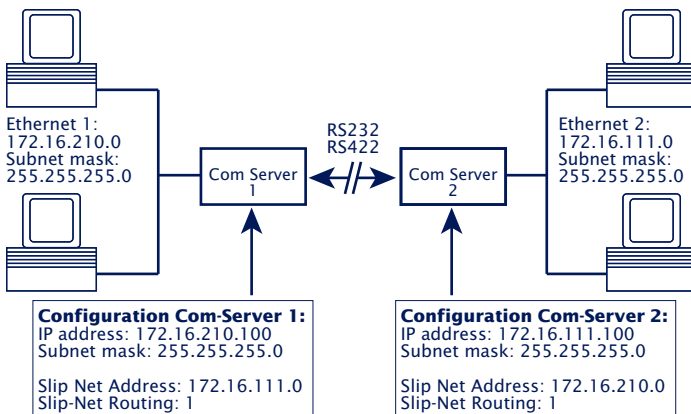

21.1.5 Configuring the Com-Server via SLIP

It is possible to open a UDP connection for configuring some Com-Server parameters through the serial connection between the Com-Server and the connected SLIP computer. The SLIP packets must be directed to the IP address 10.0.0.1 and UDP port 1111. These packets are not forwarded to the Ethernet, but rather are processed by the Com-Server and answered as appropriate.

The packets consist of IP and UDP headers as well as the configuration data, and are exchanged between the Com-Server and the SLIP computer per SLIP.

Format of the configuration data

The configuration data always start with the TYPE field, which specifies the packet type, followed by the LEN field, which specifies the length of the configuration data in bytes. Next follows a list of parameters having any length, whose content and length is indicated by a defined number (PARAM_NO).

TYPE	LEN	PARAM_NO	PARAMETER	PARAM_NO	PARAMETER	...
BYTE	BYTE	BYTE	TYPEDEF	BYTE	TYPEDEF	

The parameter list

The following Com-Server parameters can be written and/or read. Parameters of data type long or unsigned int are sent in net order, with the high byte first and the low byte last.

PARAM_NO	Parameter name	Data type	RD/WR
1	Setup TCP/IP → IP-Address	long (32 bit)	rd+wr
2	Setup TCP/IP → Subnet Mask	long (32 bit)	rd+wr
3	Setup TCP/IP → Gateway	long (32 bit)	rd+wr
4	Setup TCP/IP → MTU	unsigned int (16 bit)	rd+wr
5	... → SLIP Router → Net-Address	long (32 bit)	rd+wr
6	... → SLIP Router → SLIP-Net-Routing	unsigned int (16 bit)	rd+wr
16	MAC address	char[6] (6 bytes)	rd
17	Software version	unsigned int (16 bit)	rd

Packet types (byte TYPE)

The following three packet types are used for sending configuration data:

■ **TYPE = 1: Writing parameters in the Com-Server**

This packet is sent by the SLIP computer to the Com-Server. The Com-Server carries out the configuration and deletes the packet. A packet for configuring the IP address and subnet mask would look as follows

0	1	2	3	7	8	12
TYPE	LEN	PARAM_NO	IP-Adresse	PARAM_NO	Subnet Mask	
1	10	1	AC 19 EF 01 (172.16.231.1)	2	FF FF FF 00 (255.255.255.0)	

■ **TYPE = 2: Request for reading parameters**

This packet is sent by the SLIP computer to the Com-Server. The Com-Server sends a response type (TYPE=3) with the contents of the requested parameters. The packet contains the fields TYPE and LEN and a list of the desired parameter numbers (PARAM_NO). A packet for reading the MTU and the MAC address would look as follows:

0	1	2	3	8
TYPE	LEN	PARAM_NO	PARAM_NO	
2	2	4	16	

■ **TYPE = 3: Response to a request for reading parameters**

The Com-Server uses this packet to reply to a request for reading parameters (TYPE=2). It is used for sending the requested parameter contents. This packet is constructed like TRYPE 1. The reply to a request for parameters MTU and MAC address would look as follows:

0	1	2	3	7	8	12
TYPE	LEN	PARAM_NO	MTU	PARAM_NO	MAC address	
3	10	4	02 00 (512)	16	00 C0 3D 00 30 DB	

22 OPC data transfer

OPC (**O**le for **P**rocess **C**ontrol) is the standard software interface for manufacturer-neutral acquisition of external data sources from within visualization and SCADA systems. Regardless of whether in process-, automation- or building technology, the W&T OPC Server takes care of TCP/IP communication with the Com-Server. Both data directions for the serial devices are represented as DA items of OPC Standard 3.0.

- OPC = **O**le for **P**rocess **C**ontrol
- Download and installation of the OPC server
- Configuration of the OPC server
- Configuration of the Com-Server
- TCP ports

22.1 Overview

The W&T OPC-Server Version 4 conforms to OPC *Data Access 3.0* as well as OPC *Alarms & Events 1.10*. It is implemented as a background service, whereby client connections as well as are possible without any active user login on the respective computer. Configuration is file-based using the separate configuration program described in the following sections. In addition to the serial Com-Servers, the following W&T product families are also supported:

- Web-IO Digital (and Digital-E/A Com-Server)
- Web-IO Analog
- Web-IO Climate

The OLE server name which needs to be specified for the OPC clients in order to connect to the server, is *Wiesemann-Theis.Network-IO* for OPC DA and *Wiesemann-Theis.Network-Events* for OPC A&E.

 *The following sections describe a quick start-up which is sufficient for many applications. More detailed information for all configuration options for the W&T OPC Server can be found in the online help.*



This description refers to the OPC Server Version 4.00 and higher. Installation and configuration of earlier versions differs considerably in parts. If in doubt, please use the online help for the currently installed version.

22.2 Download and installation of the W&T OPC server

The latest version of the W&T OPC server as well as additional tools, application descriptions and FAQs can always be downloaded from our Web site <http://www.wut.de>. The simplest way to navigate from there is by using the menu tree on the left side of the page. Follow the

Downloads → Com-Servers

path to get to the website containing a direct link to the W&T OPC server.

Use of the WT OPC server in connection with W&T products is free and not subject to any licensing requirements.



22.2.1 Installation of the W&T OPC server

System requirements for installing the W&T OPC Server:

- Operating system > Windows NT inkl. 64bit and server editions
- Login als administrator or with administrator rights

 *Installation of Version 4.xx of the W&T OPC Server is done in parallel with any already existing older versions 3.xx. This means existing client projects with connections to 3.xx version OPC servers remain unaffected and may have to be manually reset for communication with the new OPC Server 4.xx.*

After downloading and unpacking the archive, start the MSI file to start installation. In addition to setting up the core driver, whereby a new program group names *W&T OPC Server Version 4* is created. This contains the following files:

- ↪  - **OPC-Server configuration**
Configuration tool for OPC server service
- ↪  - **Minimal OPC-Client**
OPC client application for testing purposes
- ↪  - **Manual**
Online documentation and help. A context-specific start can also be done by pressing the F1 key within the configuration tool

22.2.2 Deinstallation of the OPC server

The W&T OPC Server is uninstalled using Windows software administration. Start the *Software* applet in the control panel and there select the entry *W&T OPC Server*. Clicking on the *Remove* button removes the OPC Server from the system.

22.3 Configuration of the OPC server

The OPC Server is implemented as a background service, and can be used without a user login. Configuration is file-based, whereby the configuration files contain general options and a device list. Any number of these files may be stored under any desired names. This allows you for example to preserve earlier work states or administer alternate configurations.

The configuration which the OPC Server actually uses is on the other hand stored under a pre-defined name in the Windows standard directory for common application data. It is automatically read when the configuration program is started, and as long as it is open the title line shows „Active configuration“ instead of the actual file name.

 *All changes made from within the configuration tool do not become active until the menu item File → Save has been invoked as the active configuration.*

22.3.1 Optional settings on the Com-Server

Starting from the factory default setting, only the three network-specific parameters *IP Address*, *Subnet Mask* and *Gateway Address* need to be configured in order to operate the Com-Server. It is not necessary to set the serial transmission parameters such as baud rate, since these are automatically made by the OPC Server.

Local Port und Control Port



If a TCP port differing from the factory default set *8000* was entered in the *OPC server*, the corresponding values must also be configured in the menu branches of the Com-Server shown above. The *Control Port Number* used by the *OPC server* is always calculated from the formula *Data Port + 1094*.

Keep Alive Time



The factory default setting for the keep-alive check is 30 seconds. I.e. if there is no data traffic the Com-Server checks during the set time interval to see whether the connected network application can be reached. If there is no reply, for example due to a break in the network infrastructure, the Com-Server resets the connection internally and thus enables a new connection to be opened. Details can be found in section *Menu SETUP System – Setup TCP/IP*.

22.3.2 Incorporating the Com-Server into the OPC Server



After starting the OPC configuration tool, click on the *New serial device* button to start the dialog for integrating a Com-Server:

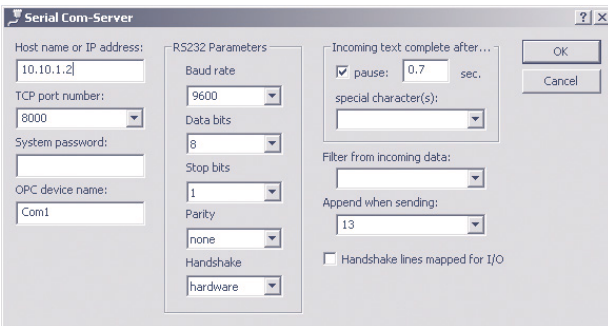

The required connection data for the Com-Server, consisting of the IP address, TCP port and system password, are entered into the corresponding fields of the following window.

The serial transmission parameters, which are also configurable here, must agree with those for the serial connected device.

22.3.3 Structuring the serial data

In order to be able to represent the received RS232 data for OPC as string variables, the data must first be broken down into packets. Packet limits are recognized here either based on pauses or by the occurrence of special character sequences. Character sequences are always indicated indirectly as decimal numbers.

Examples:

- 1.) End string: +++ → Input: 43,43,43
- 2.) End string: CRLF → Input: 13, 10

22.4 Serial OPC variables

The OPC Standards Data Access 3.0 (DA 3.0) and Alarm&Events (A&E) are supported by separate OPC Server instances.

If the client used does not support the browser function for servers and items available in the system, the following names must be used:

OPC server DA 3.0: *Wiesemann-Theis.Network-IO*

OPC server A&E: *Wiesemann-Theis.Network-Events*

Serial communication for each installed Com-Server takes place using the following variables. In contrast to the OPC Server names, these can be freely set using the configuration tool:

TxD: (VT_BSTR, W): RS232 send data, assigned values are output over the serial port.

RxD: (VT_BSTR, R): RS232 receive data (the last text packet which arrived from the serial port).

N: (VT_I4, R/W): Packet counter, is incremented by 1 each time a text packet is received.

23 Mode InQueueCopy

- Distribution of serial data streams to multiple stations

23.1 InQueue Copy

InQueueCopy enables reproducing the serial input data of the Com-Server to up to six slave applications. These must be designed as TCP clients and connect to the configured *Local Copy Port*. In combination with the *W&T COM Port Redirector* it is also possible to user serially communicating programs.

The *InQueueCopy* function works independently of the main mode used, such as *Box-to-Box*, *COM Port Redirector*, etc. All TCP packets to be sent on this main connection are also sent to the clients connected to whichever *Local Copy Port* is set. Data received within the slave connections are ignored and rejected by the Com-Server.

To prevent unauthorized access to the Copy Ports, access can be limited to particular IP addresses.

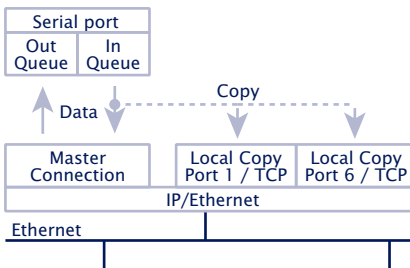

Typical Applications

- Distribution of the data polled within a master connection from a serial device (e.g. scanners, scales, etc.) to multiple stations.
- Logging serial data streams on up to six network stations.

23.1.2 Configuring InQueueCopy

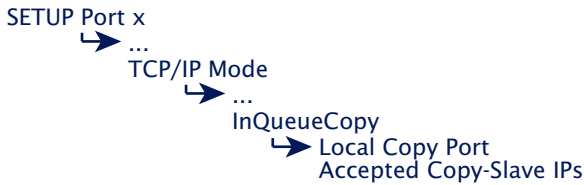

↳ **Local Copy Port**

TCP-Server port on which copies of the serial input data of the Com-Server are made available. To prevent conflicts with other standard ports on the Com-Server we recommend selecting a port number > 10,000 as the Local Copy Port.

Your own TCP socket applications connect directly to this port number. Serially communicating programs can also be used for receiving in conjunction with the *W&T COM Port Redirector*. In this case the *Local Copy Port* configured here must be assigned to the virtual COM port.

The Com-Server++ and Com-Server 20mA support max. 14 direct copy connections via TCP. If the copy connection is made through a virtual COM port on our COM Port Redirector, the number is reduced to 7. For the Com-Server 3x Isolated the limits are 24 and 12 connections, whereby the value is understood to be the sum of all three ports. If for example there are 12 copy connections to Port A and 12 copy connections to Port B, no more copy connections can be opened to Port C.

↳ **Accepted Copy-Slave IPs**

If at least one of the six possible entries is not equal to 0.0.0.0, the Com-Server allows connections to the *Local Copy Port* only from the explicitly configured IP addresses.

i *If the InQueueCopy function is activated, the status as well as the number of slave connections is displayed in the menu Setup Port x → Port State → Connection State.*

24 Status and error messages

- Status messages of the menu *Port State*
- Resetting a fixed mode: *Clear Port Mode*

24.1 Menu Setup Port x – Port State

In this menu you will find information about the configured TCP/IP mode of the Com-Server port, the status of the network connection and a listing of error which occurred. In addition, Clear Port Mode can be used to clear a fixed set mode.

↳ **Connection State**

This menu permits online connection control. The display is organized as follows:



The port is in standard mode and has no connection

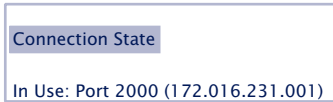

The port is in server mode and has a connection to the process having the port no. 2000 on the TCP/IP station having IP address 172.16.231.1

➔ **Client address**

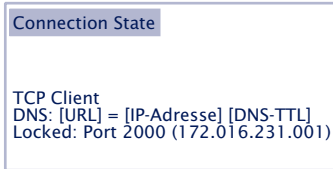

The port is configured as a TCP client and has a connection to the server process having port no. 2000 on IP station having IP address 172.16.231.1

➔ **Configured TCP/IP mode**
➔ **DNS result**
➔ **Server address**

↳ **Connection state client mode:**

- Unlock: The port is configured for the indicated mode but has **no active** connection.
- Locked: The port is configured for the indicated mode and has **an active** connection to the configured server.
- Scanning: The Com-Server wants to open a connection and **searches** for the configured server.
(in Box-to-Box mode the slave or master port)
- Disconnect: The Com-Server wants to open a connection but it is **refused** by the server.

The display is updated by exiting and then reselecting the menu item *Connection State*.

↳ **Byte Counter**

Counters for serial transmitted and received bytes since the last reset.

↳ Error State

This list shows the errors which occurred on the port. If more than five errors have occurred since the Com-Server was last reset or since the last time the error table was cleared, the oldest entry is always overwritten. The most recent entry is in first position and the oldest in last position. Preceding each entry is the time when the error occurred in hours and minutes since the last time the Com-Server was reset. You can clear the error table in order to have all the entries available again.

No halt on XOFF/RTS/DTR

The connected serial device does not respond to the stop signal set by the Com Server and continues to send data. The result may be overwriting of the serial ring buffer and loss of data. Please check to be sure the handshake configurations for the devices agree and the connection cable is properly wired.

Overrun Error

The data register of the serial receiver component was written even though the previous character could not be read out. Since this is a purely device-internal event, this error message is strongly indicative of a Com Server hardware error.

Parity Error

A character received on the serial port has an incorrect or missing parity bit. Please check that the transmission parameters for the Com Server and the corresponding serial terminal device are the same. Parity errors can also be caused by use of excessively long cable.

Framing Error

A character received on the serial port does not fit in the time frame that results from the configured transmission parameters (baud rate, start bit, data bits,

parity bit, stop bits). Please check here also that the Com Server and serial terminal device configurations are the same.

↩ **Clear Port Mode**

Use this command to simply and easily revert the port to standard TCP/IP mode. The previously configured TCP/IP mode (TCP-, UDP-, Telnet-, FTP-Client, Box to Box, Bus IP Mode) is deleted.

 *The changes made using Clear Port Mode are also effective without SAVE Setup after exiting the menu, i.e. they are saved directly in the non-volatile memory.*

25 Expanded services of the Com-Server

In the preceding sections we explained all the standard processes that are implemented in the Com-Server. These client/server processes cover the majority of the application possibilities for the Com-Server. Implementation of more complex scenarios often requires however that the software be individually adapted.

For users who make use of socket programming, the Com-Server offers additional functions beyond pure data transfer.

- The control port and its data structure
- Status requests and configuration of the serial port
- Resetting the Com-Server
- Uploading/downloading of the configuration data
- Inventory taking per UDP
- SNMP management

25.1 The control port

The TCP client and TCP server processes for sending data to the serial port of the Com-Server do not allow influencing the serial port itself. But some applications make it necessary that the status and configuration of the port be known and capable of being changed at all times.

Parallel with the data connection to the *Local Port*, a control connection can be opened on the TCP *controlport*. Through this connection it is possible to read out the current status of the port (handshake lines and error states) or to dispatch commands. The user data itself is only transported through the actual data connection.

The TCP port number of the control port is stored in the menu branch *Setup Port x* → *TCP/IP Mode* → *Control port*. The following port numbers are pre-configured at the factory:

- Port A = 9094
- Port B = 9194
- Port C = 9294

 *The control connection can only be opened if the Com-Server port functions as a TCP server. In Box to Box mode this service is not available.*

The data- and control ports are independent of each other. They may be individually opened and closed whenever desired.

Use of the system password

If a system password has been configured (see section *Basic Configuration of the Com-Server*), this must be null-terminated ([password] + 0x00) and sent to the Com-Server via the Control Port within 2s after a connection has been successfully opened. If the Com-Server does not receive a correct or even any password within this time, it sends the message *PASSWD?* followed by a null byte (0x00) to the client and closes the TCP connection.

If no *system password* is configured, you can begin with exchange of the info structures immediately after the TCP connection is opened, as described in the following.

25.1.1 The control structure

For the purpose of exchanging information and commands, data records having a defined length and structure are exchanged through this connection.

To request an info structure (completely filled data record from the Com-Server port), you only need to send any desired character to the control port. To despatch a command, the Com-Server expects the complete structure (30 bytes) in a TCP packet. If no allocatable data (e.g. just half of a structure) pass through the contro port, the reply is still an info structure. The declaration of the structures is made in C language. Note for all structures:

A ***word*** corresponds to a 16-bit-Integer

A ***char*** corresponds to a byte (8bit)

Hex convention: ***0x*** preceding the value

The info structure has a fixed length of 30 bytes and is comprised of the following individual structures:

```
#pragma pack(1) //Structure components have 1-byt bounderies
typedef struct _rem_box_ctrl
{
    char        zero_1;
    COM_ERROR   _ce;
    COM_STAT    _cs;
    BOX_CNTRL   _bc;
    char        zero_2;
} REM_BOX_CNTRL;
#pragma pack()
```

zero_1/zero_2

The two characters *zero_1* and *zero_2* are the start and end characters of the structure and must always be zero.

The structure `COM_ERROR`

The `COM_ERROR` structure has a length of one WORD (16-bit integer) and contains all the error states of the serial port.

```
typedef struct _com_error
{ union
  { word error_flags;
    struct _err_flags
    { word f_data          : 1; //not used/reserved
      word f_net          : 2; //not used/reserved
      word f_com          : 1; //Set when COM port error detected
      word f_break       : 1; //Reflect the break flag
      word f_cts_time    : 1; //Time out while waiting on CTS
      word f_dsr_time    : 1; //Time out while waiting on DSR
      word f_rlsd_time   : 1; //Time out while waiting on RLSD (CD)
      word f_overrun     : 1; //Overrun error
      word f_parity      : 1; //Parity error
      word f_frame       : 1; //Framing error
      word f_status      : 1; //not used/reserved
      word no_use_1      : 1; //not used
      word no_use_2      : 1; //not used
      word f_rx_over     : 1; //Ring buffer overrun after handshake
      word no_use_3      : 1; //not used
    };
  };
} COM_ERROR;
```

The structure `COM_STAT`

The `COM_STAT` structure has a length of three WORDS (16-bit integer) and contains the status of the handshake lines as well as the number of bytes which are in the send and receive buffers of the serial port. It also allows you to directly influence the handshake lines and buffer.

```
typedef struct _com_stat
{ union
  { word com_flags;
    struct _com_flags
    { word cts_hold      :1; //CTS line           -LowByte
      word dsr_hold     :1; //DSR line           |
      word ri_hold      :1; //not used/reserved |is set with every
      word rlsd_hold    :1; //reserved/reserved |received packet
      word dtr_hold     :1; //DTR line           |
      word rts_hold     :1; //RTS line           |
      word x_receive    :1; //XOFF received      |
      word x_send       :1; //XOFF was send      -
    };
  };
};
```

```

word break_mode      :1;    //1 = set_break was set      - HighByte
                      //0 = clear_break was set      |
word dummy           :1;    //not used                               |
word send_xoff       :1;    //Send XOFF asynchron                            |
word flush_rd        :1;    //Flush serial input buffer                       |
word flush_wr        :1;    //Flush serial output buffer                      |
word set_rts_dtr     :1;    //set RTS to rts_hold and                       |
                      //DTR to dtr_hold           |
word set_break       :1;    //Independent setting break                       |
                      //mode                               |
word clear_break     :1;    //Independent clearing break                       |
                      //mode                               -
};
};
word cbInQue;          //Receive byte count of COM ring buffer
word cbOutQue;        //Transmit byte count of COM ring buffer
} COM_STAT;

```

Flushing buffers and influencing the handshake:

- 1) Copy the complete structure of an info packet received by the Com-Server port and fill in the HighByte of the `COM_STAT` structure.
- 2) All commands whose flags have the value `1` are executed. If you set the flag `set_rts_dtr`, be sure that you also set the flags `rts_hold` and `dtr_hold` in the LowByte correspondingly as well.

 Depending on how the Com-Server and the `box_cntrl.f_flags` structure are configured, the RTS and DTR signals will be used for a LOCK/UNLOCK display or for serial flow control. In this case the Com-Server itself takes over control of these pins. The command flag `set_rts_dtr` should therefore be used only for the following setting of the `box_cntrl.f_flags` structure:

```

f_rts_disable und f_dtr_disable = 1
f_inx_dtr und f_inx_rts = 0

```

Sending a break signal

The `set_break/clear_break` flags can be used to activate/deactivate break mode and send a break signal to the serially connected device. Activated break mode is signaled by `break_mode=1`. After setting `set_break`, break mode is ac-

tivated and break signal is generated. The level of the data output remains inverted until break mode is deactivated again by setting *clear_break*.

Structure BOX_CNTRL

The *BOX_CNTRL* structure (20 bytes) is used to store the port configuration (baud rate, data bits, parity, stop bits, handshaking, timing values, etc.). Here you can influence the parameters and how they are saved.

```
typedef struct _box_cntrl
{
    struct_baud_fifo
    {
        char baud :5; // Baud rate for channel
        // 11 = 230400 6 = 2400
        // 14 = 153600 7 = 1200
        // 15 = 115200 8 = 600
        // 0 = 57600 9 = 300
        // 1 = 38400 10 = 150
        // 2 = 19200 16 = 110
        // 3 = 9600 12 = 75
        // 5 = 4800 13 = 50
        // Baudrates are coded within the first 5 bits

        char fifo_aktiv :1; // ignored by models 58661, 58665, 58664
        char fifo :2; // ignored by models 58661, 58665, 58664
    };
    char bits;

    // 00xx.xxxx data bits, stop bits, parity
    // |-----|-----|-----|-----|
    // | | | | |-----| 10 = 7 data bits
    // | | | | |-----| 11 = 8 data bits
    // | | | | |-----| 0 = 1 stop bit
    // | | | | |-----| 1 = 2 stop bits
    // | | | | |-----| 1 = parity enable
    // | | | | |-----| 0 = odd parity
    // | | | | |-----| 1 = even parity
    // | | | | |-----| 1 = stick parity
    // (stick/odd = MARK
    // stick/even = SPACE)
    // ignored by model 58662

    word RLS_time_out; //Timer before f_rlsd_time will be set
    word CTS_time_out; //Timer before f_cts_time will be set
    word DSR_time_out; //Timer before f_dsr_time will be set
    char XONChar; //Char excepted as XON
    char XOFFChar; //Char excepted as XOFF
    word hs_on_limit; //if number of free bytes in ring buffer
    //> hs_on_limit then clearing handshake stop
    word hs_off_limit; //if number of free bytes in ring buffer
    //< hs_off_limit then setting handshake stop
    char PEChar; //Replace this char if serial parity error (function
    //must be enabled first by setting f_flags.f_pechar=1)

```

```

struct _commands
{
    unsigned char save_command :4;    //Save COM-Configuration
                                      //0 = no save
                                      //1 = save without EEPROM Update
                                      //2 = save with EEPROM Update

    unsigned char clear_error :1;    //1 = clear error in display/lamps
    unsigned char set_fact_def :1;   //1 = set factory defaults and reset
    unsigned char free_cmd :2;       //not used
};

union
{
    word hs_flags;
    struct_hs_flags
    {
        word f_   cts_connect :1; //
        word f_   dsr_connect :1; //
        word f_   cts_accept  :1; //
        word f_   dsr_accept  :1; //
        word no_use0          :12; // not used
    };
};

union
{
    word f_flags;
    struct_f_flags
    {
        word f_rts_disable :1; //RTS will not change at LOCK/UNLOCK
        word f_dtr_disable :1; //DTR will not change at LOCK/UNLOCK
        word f_outx        :1; //Enable softw. handshake while sending
        word f_inx         :1; //Enable softw. handshake while receiv.
        word f_outx_cts    :1; //Enable hardware handshake on CTS
        word f_outx_dsr    :1; //Enable hardware handshake on DSR
        word f_inx_dtr     :1; //Enable hardware handshake on DTR
        word f_inx_rts     :1; //Enable hardware handshake on RTS
        word f_parity      :1; //Enable parity check & error report
        word f_pechar      :1; //Enable replacement of received char
        word f_inxfilter   :1; //Enable xon/xoff filter while receiving
        word f_outxfilter  :1; //Enable xon/xoff filter while sending
        word f_rts_default :1; //1 = While RTS is not used, RTS
                               //is active
        word f_dtr_default :1; //1 = While DTR is not used, DTR
                               //is active
        word f_user_time   :1; //not used
        word clr_err_char  :1; //1= If Com-Server is in client mode,
                               //serial chars with framing or parity
                               //errors will not open the connection
    };
};
} BOX_CNTRL;

```

Configuring the serial port

1. Copy the complete structure of an info packet received by the Com-Server and fill in the BOX_CNTRL structure. This allows you to read out the default values and only enter the values you want to change.

2. To work with the configuration, the value *save_command* in the structure has to be set. *save_command* = 2 causes the Com-Server to save this configuration in non-volatile memory and to use it again after a restart. A 1 does not overwrite the non-volatile memory, i.e. after a restart the old configuration is used.

Functions of the RS232 outputs RTS and DTR

If the flags *f_rts_disable* and *f_dtr_disable* are set to 0, the corresponding RS232 output uses an enable level to signal to signal an active connection between the serial port and a client in the network. If the Com-Server itself is configured as a TCP client, a constant enable level is output, regardless of whether there is an active connection or not.

Alternately a 1 in the flags *f_inx_rts* and *f_inx_dtr* can assign the function of serial flow control to the respective RS232 output. If flow control is enabled, the corresponding flag for the *LOCK/UNLOCK* display must have the value 1 (= *LOCK/UNLOCK* display disabled).

If the respective RS232 output does not have the function of either *LOCK/UNLOCK* display or flow control, the flags *f_rts_default* and *f_dtr_default* can be used to specify the default state after a Com-Server reset (1=Enable, 0=lock level).

 *The model Com-Server 20mA 58664 only supports the data channels Rx and Tx. No hardware handshake or other access to the control lines is possible with this model.*

25.2 Reset Com-Server port

Factory default = 9084, 9184, 9284/TCP for ports A, B, C

For special applications this port makes it possible to carry out a forced reset of the Com-Server port. All current connections to the serial port are immediately closed, regardless of whether the respective partner is reachable.

 *The factory default port number under which this service can be reached is configured and deactivated in the menu branch SETUP System → Setup TCP/IP → System Port List*

 *For automatic detection and preventing the TCP connections from hanging, we recommend using the keep-alive function of the Com-Server.*

Use of the system password

If a system password has been configured (see section „Basic Configuration of the Com-Server“), this must be null-terminated (= [password] + 0x00) and sent to the Com-Server via the Control Port within 2s after a connection has been successfully opened. If the Com-Server does not receive a correct or even any password within this time, it sends the message PASSWD? followed by a null byte (0x00) to the client and closes the TCP connection.

If no system password is configured, then as the example shows the Com-Server immediately closes the TCP connection as soon as it has been established and performs a port reset.

 *When invoking this service, the contents of the serial in- and output buffer are lost. The port can be opened by any desired station and should only be used in extreme cases! No data excepting the password are permitted to be transported through this connection! The port is opened by a host and then immediately closed by the Com-Server.*

25.3 Com-Server reset

Factory default: 8888/TCP

The reset socket has been implemented in case the Com-Server ever needs to be completely reset. If a connection is opened on this port, the Com-Server immediately closes it again and then performs a software reset.

 *The factory default port number under which this service can be reached is configured and deactivated in the menu branch SETUP System → Setup TCP/IP → System Port List*

Use of the system password

If a system password has been configured (see section „Basic Configuration of the Com-Server“), this must be null-terminated (= [password] + 0x00) and sent to the Com-Server via the Control Port within 2s after a connection has been successfully opened. If the Com-Server does not receive a correct or even any password within this time, it sends the message *PASSWD?* followed by a null byte (0x00) to the client and closes the TCP connection.

If no system password is configured, then as the example shows the Com-Server immediately closes the TCP connection as soon as it has been established and performs a port reset.

 *Following this reset all the buffer contents are deleted and any still active connections are closed - the Com-Server is in its base state! This reset can be performed from any station and should be done only in extreme cases.*

25.4 Up-/downloading configuration data

Factory default: 8003/TCP=read, 8004/TCP = write

These services allow you to read out the configuration data for the Com-Server stored in the non-volatile memory and send it to another Com-Server. Especially when installing a large number of Com-Servers having the same settings this method eliminates having to open a Telnet configuration connection for each individual unit.

 *The factory default port number under which these services can be reached is configured and deactivated in the menu branch SETUP System → Setup TCP/IP → System Port List*

Use of the system password

If a system password has been configured (see section *Basic Configuration of the Com-Server*), this must be null-terminated (= [password] + 0x00) and sent to the Com-Server via the Control Port within 2s after a connection has been successfully opened. If the Com-Server does not receive a correct or even any password within this time, it sends the message PASSWD? followed by a null byte (0x00) to the client and closes the TCP connection.

If no system password is configured, the Com-Server expects or sends the configuration data directly after the TCP connection has been established.

Reading out the configuration data on port 8003

All the client application needs to do is open a TCP connection to Port 8003 of the Com-Server. The Com-Server accepts it, automatically sends its 2048-byte long configuration and then closes the connection to the client.

The client application can store this data now in a binary file and use it for downloading to other Com-Servers.

Writing configuration data on port 8004

Uploading to a Com-Server is analogous to reading out the configuration data. After opening a TCP connection to Port 8004 of the Com-Server, the latter expects the 2048 bytes for a new configuration. After the client closes the TCP connection, the Com-Server saves the data in its non-volatile memory and performs a reset.

The value of the IP address remains unaffected by a configuration upload.

Application

To operate multiple Com-Servers having the same configuration, you must first assign each unit with its own IP address. Then use Telnet to fully configure a Com-Server with the desired parameters and use Port 8003 to read the non-volatile memory out. The file thus created can now be uploaded to the remaining Com-Servers.

 *The procedure described here is a substitute for the relatively time-consuming configuration using a Telnet session. All the settings are saved in the non-volatile memory and are still available after a reset or power loss. Only a factory default reset overwrites the settings assigned by the factory set standard values.*

25.4.1 Up-/downloading under Windows

For Windows computers you can also up- or download the configuration data using the W&T tool *WuTility*, which is also used for the firmware update. You can find a corresponding download link on the Web data sheet pages for the Com-Servers at the following address: <http://www.wut.de>

25.5 Inventory taking per UDP/8513

UDP port 8513 allows you to open an info-structure with device-specific information from the Com-Server. After receipt of a network-specific packet with any contents directed to this port, the Com-Server replies with the info-packet. By configuring the request packet as a broadcast, you can inventory all the W&T devices located in the local network.

 *The factory default port number under which this service can be reached is configured and deactivated in the menu branch SETUP System → Setup TCP/IP → System Port List.*

25.5.1 The infopaket

Each infopacket consists of 3-6 data structures. *BOX_VERSION* contains information on the respective model of the Com-Server and its firmware status. The structure *BOX_DESCRIPT* provides the network-relevant data such as MAC- and IP-address. The 3.-6. structure *PORT_DESCRIPT* provides information about the configured mode and the current connection status of the individual ports. The total length of the InfoPacket is calculated as follows: $10 + 22 + (\text{port_no} \times 10)$ bytes.

```
#pragma pack(1)
typedef struct _BOX_VERSION           // ( 10 byte )
{
    unsigned int version;             // 0x10: 1.0 (Version of this structure)
    unsigned int sw_rev;              // z.B. 1.24 (0x1501)
    unsigned int hw_rev;              // C2_EURO           = 2.0 (0x0002)
                                        // C4_MINI           = 4.0 (0x0004)
                                        // C5_100BT         = 5.0 (0x0005)
                                        // C8_LOW_VOLTAGE  = 8.0 (0x0008)
                                        // C90 Com-Server++ = 9.0 (0x0009)
    unsigned int reserved[2];
}BOX_VERSION;

typedef struct _BOX_DESCRIPT          // ( 22 byte)
{
    unsigned char mac_addr[6];        // MAC address of Com-Server
    unsigned long IP_number;          // IP address of Com-Server
    unsigned long gateway;            // Gateway
    unsigned long subnet_mask;        // Subnet mask
    unsigned int MTU;                 // MTU
    unsigned int port_anz;            // Number of serial ports of Com-Server
}BOX_DESCRIPT;                       // (port_anz * 10 byte)
```

```

typedef struct _PORT_DESCRIPTOR      // ( 10 byte )
{ union
  { unsigned int wState;
    struct _new_type
      { unsigned char port_type; //0x01   = serial port (serial CPU port)
                                           //0x02   = Serial port (UART port)
                                           //0x03 = reserved
                                           //0x04 = Digital E/A
                                           //0x05   = reserved
                                           //0x06 = W&T Dual Port RAM
        unsigned char state; //0=free, 1=connect, 2=waits
      };
    };
  unsigned int mode; //0x0001 = TCP client
                    //0x0002 = TELNET client
                    //0x0003 = FTP client
                    //0x0004 = Box2Box client (active)
                    //0x0005 = UDP Send/ReceiveMode
                    //0x0006 = MULTI PORT (DPRAM, SERIAL PROT.)
                    // 0x0007 = SNMP agent
                    // 0x0008 = Box2Box server (passive)
                    // 0x0010 = SLIP router
                    // 0x0020 = PPP router (in preparation)
                    // 0x0030 = Box2Box bus system: Slave box
                    // 0x0040 = Box2Box bus system: Master box
    unsigned long remote_IP; // if state == CONNECT, else 0
    unsigned int remote_port; // if state == CONNECT, else 0
}PORT_DESCRIPTOR;

typedef struct _WT_INTERN3 // ** all parameters in Hostorder/Low Byte First **
{ BOX_VERSION bv; // Port = UDP_BOX_INFO_8513
  BOX_DESCRIPTOR bd;
  PORT_DESCRIPTOR pd[ACT_PROCESS];
} WT_INTERN3;
#pragma pack()

```

i All variables of types Integer and Long are mapped in host order, i.e. the low-value bytes come first. The IP address 172.17.2.3 appears for example in byte order 3, 2, 17, 172.

UDP packets are connectionless and unsecure datagrams. Especially when using broadcasts the Com-Server's own request as well as reply packet can get lost. To reliably ascertain all the Com-Servers installed in a subnet you should therefore repeat the broadcast if necessary.

25.6 SNMP management

Many networks are managed through a central network management system using SNMP protocol. For this purpose the Com-Server supports parts of the MIB2 for read access via SNMPv1.

A private branch with associated MIB which provides read and write access to all the configuration parameters of the Com-Server is in preparation.

 *The factory default port number under which this service can be reached is configured and deactivated in the menu branch SETUP System → Setup TCP/IP → System Port List.*

 *If a system password was configured in the Com-Server, queries from SNMP managers are only answered if the community contained there corresponds to the system password.*

26 Firmware-Update of the Com-Server

Since the operating software is under constant development, this device also allows you to perform a firmware update. The available upload variations are described here.

- Where do I get the current firmware?

- Network firmware update under Windows

26.1 Where do I get the current firmware?

The most current firmware including update tools and a revision list is published on our Web site at the following address:

<http://www.wut.de>

From there it is easiest to navigate using the Search function located on the left side. In the entry field first enter the model number of your device. Select *Firmware* in the associated selection box and click on the *Go* button.



This takes you directly to the page with the most up-to-date firmware for your Com-Server model.

If you do not know the model number, you can find it on the sticker located on the narrow side of the enclosure, likewise the Ethernet address.

Model number

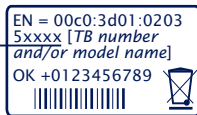

i In particular if the sticker indicates an TB number as the part number, it is possible that the Com-Server has a special, customer-specific firmware or configuration. Please contact the responsible administrator in such cases before the update.

26.2 Network firmware update under Windows

Required is a PC running Windows >NT with a network connection and activated TCP/IP stack. For the update process you need two files which, as already mentioned, are available for download from our Web site at <http://www.wut.de>.

- The executable update tool for transferring the firmware to the Com-Server.
- The file with the new firmware for transferring to the Com-Server.

It is not necessary to do any special preparation in the Com-Server for a firmware update. You only need to close all data, control and configuration connections.

 *The factory default port number under which the services required for firmware update can be reached are configured and deactivated in the menu branch SETUP System → Setup TCP/IP → System Port List*

Highlight the desired Com-Server in the WuTility inventory list. The *Firmware* button starts the Update dialog box in which you must specify the file name of the new firmware (*.uhd). After checking the compatibility of the specified firmware for the selected Com-Server, WuTility activates the *Next* button which starts the actual file upload.

Additional information can also be found in the WuTility online help.

 *Never interrupt the update process by pulling the power plug or pressing the reset button. The Com-Server will be non-operational after an incomplete update.*

26.2.1 Update in routed environments

The WuTility Update Wizard divides itself on the network side into three steps, whereby the specified TCP and UDP services are used:

1. Identification/Inventory of the device
Destination port Com-Server: UDP/8513
2. Initialization of the update process
Destination port Com-Server: TCP/8002
3. Upload firmware
Destination port Com-Server: UDP/69 (TFTP)

The previously described automatic processing of the update requires that any security components (firewalls, routers ...) used between *WuTility* and the Com-Server allow transparent communication via these services.

The TFTP port is required for actual sending of the firmware. Identification and initializing however can be done manually.

Manual device entry in the inventory list

If UDP port 8513 for example is blocked by a firewall, automatic inventorying using *WuTility* is not possible. In this case the Com-Server can be manually entered in the inventory list using the menu item *Add device*.

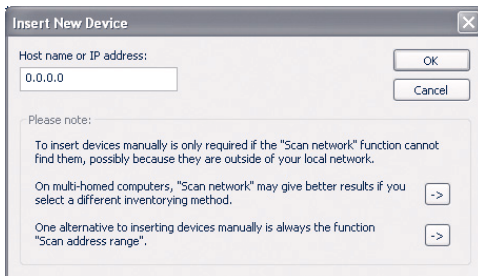

Enter the IP address of the Com-Server in the corresponding entry field and click on *OK* to close the dialog box. The device is added to the inventory list.

? 00c03d:000000 192.168.0.50 Com-Server 10BaseT ?

Highlight the desired Com-Server in the WuTility inventory list with the right mouse button and choose *Properties*.

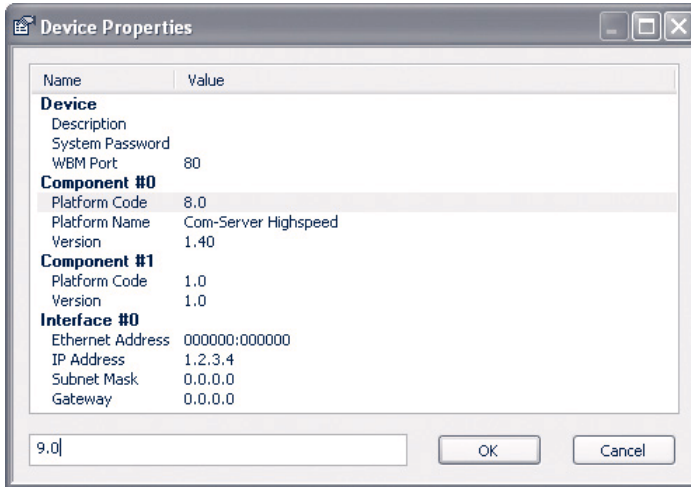

Highlight the line *Component#0* → *Platform Code* and enter the value 9.0 for the Com-Server++, 58665 and Com-Server 20mA, 58664 in the corresponding entry field. For the Com-Server 3x Isolated, 58662 enter the value 9.2.

Manual initializing of the update process

For security reasons the Com-Server must first be initialized for receiving new firmware. This initializing is done using Telnet or Web-Based-Management:

Telnet: *SETUP System* → *Flash update*

WBM: Logout page → Button *Firmware update*

 *Activating update mode closes all open TCPconnections to the Com-Server. At the same time all network services (including PING) are stopped. A return to standard mode is only possible by sending firmware or performing a hardware reset of the Com-Server.*

26.3 Incomplete and interrupted updates

The Com-Server automatically detects an incomplete or interrupted firmware transmission – caused for example by a power or network failure – and after a restart automatically resumes update mode. The update can in this case be restarted under the previous IP address.

It may be that the Com-Server must be manually added to the WuTility inventory list for this purpose. For details, see the previous section.

Appendix

- Port numbers and services
- Network security
- Example: Serial assignment of the IP address under Windows
- Technical Data

A1 Ports and services

With the factory setting, Com-Servers provide the TCP/UDP services listed in the tables. All these services can be configured and deactivated via the port management of the Com-Server in the following menu branches:

Setup System -> System Ports

Setup Port x -> TCP/IP Mode -> Port List

Com-Server++ (58665) und Com-Server 20mA (58664)

Port-/Socket-number	Service	Password protected?	configurable?
8000 (TCP)	Socket Server Port A	no	yes
Details:see chapter: <i>Mode TCP-Server, Mode W&T COM Redirector</i>			
1111 (TCP)	Telnet configuration	yes	yes
Details:see chapter: <i>Configuration access to the Com-Servers</i>			
9094 (TCP)	Controlport port A	yes	yes
9084 (TCP)	Reset port status port A	yes	yes
8888 (TCP)	Reset Com-Serves	yes	yes
8002 (TCP)	Initialize firmware update	yes	yes
8003 (TCP)	Read configuration data	yes	yes
8004 (TCP)	Write configuration data	yes	yes
8513 (UDP)	Inventory	no	yes
161 (UDP)	SNMP agent	yes	yes
Details:see chapter: <i>Expanded services of the Com-Servers</i>			

Com-Server PoE 3xIsolated (58662)

Port-/Socket-number	Service	Password protected?	configurable?
8000 (TCP)	Socket Server Port A	no	yes
8100 (TCP)	Socket Server Port B	no	yes
8200 (TCP)	Socket Server Port C	no	yes
Details:see chapter: <i>Mode TCP-Server, Mode W&T COM Redirector</i>			
1111 (TCP)	Telnet configuration	yes	yes
Details:see chapter: <i>Configuration access to the Com-Servers</i>			

9094 (TCP)	Controlport port A	yes	yes
9194 (TCP)	BControlport port B	yes	yes
9294 (TCP)	Controlport port C	yes	yes
9184 (TCP)	Reset port status port A	yes	yes
91284 (TCP)	Reset port status port B	yes	yes
9084 (TCP)	Reset port status port C	yes	yes
8888 (TCP)	Reset Com-Serves	yes	yes
8002 (TCP)	Initialize firmware update	yes	yes
8003 (TCP)	Read configuration data	yes	yes
8004 (TCP)	Write configuration data	yes	yes
8513 (UDP)	Inventory	no	yes
161 (UDP)	SNMP agent	yes	yes
Details: see chapter: <i>Expanded services of the Com-Servers</i>			

 Depending on the Com-Server operating mode used, additional ports or services can be activated and/or others omitted. Further information can be found in the chapters of the individual operating modes.

 Each port number may be used for just one service in the Com-Server. If differing numbers are used for changeable ports, be sure that these are not assigned in duplicate.

A 2 Network security

Com servers are based on a W&T-owned operating system whose core is free of open source components and third-party software.

The factory default settings of the Com-Server are designed for operation in a secure network environment, with the focus on low-latency transmission of serial data and uncomplicated commissioning and configuration.

In insecure network environments or with increased security requirements, additional measures must be taken to avoid unauthorized access.

The following chapters provide an overview of possible security measures. It is assumed that the standard firmware is used without customer-specific adaptations. Further details can be found in the respective sections of this manual.

A2.1 Secure commissioning and configuration

With the factory setting, all configuration services are freely accessible. Commissioning must therefore be carried out in such a way that no unauthorized access can take place until the system password has been assigned and a secure configuration has been made.

In these cases, we recommend that the initial commissioning be carried out in a secure network environment with only trustworthy participants. Alternatively, a point-to-point connection to the configuration computer is also suitable.

Assignment of a system password

All control and configuration accesses to the Com-Server are protected by the system password. No system password is preset ex works and all settings and functions are fully ac-

cessible without protection. To prevent unauthorized access, we therefore recommend that you configure a secure system password consisting of at least 15 characters and containing upper/lower case letters, numbers and special characters. Further measures, such as a regular password change, are to be ensured organizationally if necessary.

The system password is only transferred to the Com-Server in encrypted form for WBM access via HTTPS. All other services transmit the password in plain text. For password-protected access from allegedly insecure or public networks, additional measures such as the use of a VPN tunnel must be taken.

Disabling unneeded services

Disable all services and ports that are not required for your application. A list of all services can be found at the beginning of this chapter. Details on the ports required for the respective operating mode of the Com-Server can be found in the corresponding chapters of this manual.

In some applications it may also be useful to switch off the configuration accesses. However, since this measure can only be reversed by resetting to the factory setting, this measure should only be taken in justified exceptional cases.

Configuration via HTTPS if possible

The TLS protocol used by HTTPS provides encrypted and authenticated access to the web-based management of Com servers. To protect the exchanged configuration data and the system password, we recommend the activation of HTTPS especially in insecure network environments. To protect against man-in-the-middle attacks, the self-signed default certificate should be replaced by an individual certificate.

 *The compute-intensive TLS encryption functions can influence the latencies of serial data transmission. Time-critical serial protocols should therefore be tested for compatibility with parallel HTTPS access. This especially includes possible security scans in the network. These may open a large num-*

ber of TLS connections within a short period of time and can therefore lead to interruptions or timeouts of the serial data traffic.

Registration for safety-relevant information

Devices can be registered at W&T using the WuTility inventory tool. In case of security updates and/or information, we will notify you immediately by email. In addition to the personal data provided, the device-specific data will be saved during registration.

A2.2 Secure operation of the Com-Server

For the operation of the Com-Server in applications with increased protection requirements, the following points should be considered and, if necessary, implemented:

Isolation of the subnet via router/firewall

The connection between the Com-Server and the application in the network is unencrypted in order to ensure the latency-free transport of serial data. Depending on the application, communication can be outsourced to an island network using a firewall (e.g. W&T Microwall). Using suitable whitelist rules, such segmentation offers protection against spying and unauthorized access.

Communication via VPN

If communication is to take place via insecure networks or the Internet, we recommend the use of a VPN connection. In addition to data encryption, VPN solutions often also include a firewall function and thus offer protection against unauthorized access (e.g. W&T Microwall VPN).

A2.3 Service and maintenance

Safe the system password

After successful commissioning, configuration accesses to the Com-Server are usually rare. If the password is no longer available in such cases, it can only be cleared by resetting the Com-Server to the factory defaults. We therefore recommend that you store or save the password in a secure manner, e.g. in paper form.

Precautions Hardware failure

Despite a high quality standard, electronics can fail at any time, e.g. due to external events. Depending on the sensitivity of the application, we therefore recommend taking appropriate precautions:

- Backup and storage of the Com-Server configuration file
- Provision of a replacement device is necessary
- Documentation of the procedure for a device replacement

A3 Serial assignment of the IP address under Windows

Serial assigning of the IP parameters can be done using the free mini-terminal program *Easyterm*, which has been optimized especially for this task. Alternately of course you can use any other terminal program (e.g. PuTTY).

Easyterm

The most current version of the tool can be downloaded from our Web site at <http://www.wut.de>.

The simplest way to navigate from there is by using the product overview on the left side of the page. Follow the

Downloads -> Com-Server

path to get to the menu branch containing a direct download link for the tool.

After starting the program, you must simply select the COM port the Com-Server is connected to from the lower pull-down menu and then click on the Open button. All serial transmission parameters are already preset.

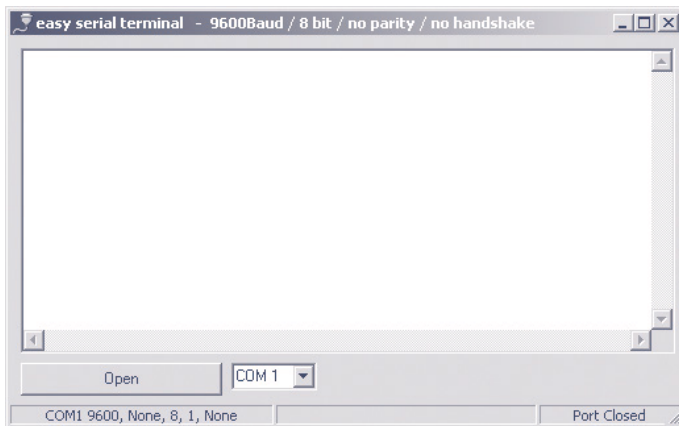

Now turn the Com-Server on and off to reset it and while it is starting up hold down the „x“ key (lower case, no Caps Lock!). After about 2-3 seconds the prompt *IP no.:+<ENTER>*: will ap-

pear in the terminal window.

 *The Com-Server 20mA 58664 has a TTY interface and can therefore not be connected directly to the standard COM port (RS232) of a PC.*

Now enter the IP address you want to assign in the usual dot notation (e.g. 172.17.10.10). There will be no immediate echo of characters, so the individual inputs will not be seen on the monitor. Only after you have pressed Return to confirm is the completely entered IP address returned by the Com-Server.

Each separated by a comma, this method can also be used to assign subnet mask and gateway address.

Example 1

Assigning only the IP address:

```
172.15.222.5 <ENTER>
```

Example 2

Assigning IP address, Subnet Mask, Gateway:

```
172.15.222.5,255.255.0.0,172.15.222.1 <ENTER>
```

Example 3

Assigning IP address, Subnet Mask, Gateway and activating Web Based Management on TCP port 80:

```
172.15.222.5,255.255.0.0,172.15.222.100+80 <ENTER>
```

 *To avoid unintended changes to the IP address, the DHCP client of the Com-Server is automatically deactivated when configuring using the serial port.*

 *If you have made improper entries or typing mistakes, the Com-Server will return FAIL followed by its actual current IP address. The procedure must then be repeated.*

PuTTY

The free terminal program PuTTY can also be used for serial IP assignment.

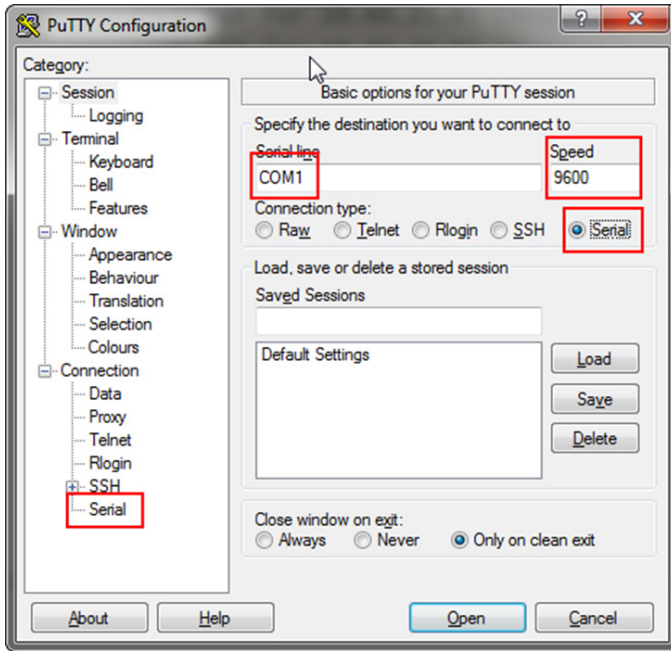

After starting PuTTY, check the settings marked in red. The transmission parameters must be 9600 baud, 8 data bits and no parity.

A click on *Open* starts the terminal session and you can assign the serial parameters as described in the previous Easy-term example.

i To avoid unintended changes to the IP address, the DHCP client of the Com-Server is automatically deactivated when configuring using the serial port.

A4 WuTility - Inventory and management tool

In Windows environments the WuTility Tool can also be used for inventory and management of Com-Server installations. Pressing a button lists all the Com-Servers located in the local network together with their key data. Following are the most interesting functions which can be run directly from the list:

- ✓ Assigning the IP address, even if the currently set address does not fit in the local network
- ✓ Copying of entire configuration blocks from one Com-Server to any other
- ✓ Creating and archiving configurations
- ✓ Firmware updates

Where do I obtain this tool?

The latest version is always published on our Web pages at the following address:

<http://www.wut.de>

The simplest way to navigate from there is by using the product overview on the left side of the page. Follow the

Downloads -> Com-Server

path to get to the menu branch containing a direct download link for the tool.

A5 Hardware-Reset to factory defaults

In addition to resetting the Com-Server to its factory defaults using the Telnet configuration (Port 1111), this can also be done via hardware. For this purpose the Com-Server has a jumper on the board. For normal operation this jumper must be out. To set the factory defaults, proceed as follows:

- Power off the Com-Server and open the enclosure
- Close the jumper and reconnect the supply voltage. An internal self-test will be performed during which messages will be issued on serial port A. The *Fail* messages in the lines *Port A:* and *TP Test:* can be ignored.
- The self-test will be finished in approx. 20s, at which point the factory defaults are active.
- Turn off the Com-Server, open the jumper and close up the housing again.

 *Resetting the non-volatile memory results in a loss of all the settings which are different from the factory defaults, including the IP address.*

A6 Technical data and formfactor 58665

Supply voltage ...	37 - 57V DC from PSE
Power-over-Ethernet	
External supply...	
... DC	12 - 48V DC (+/- 10%)
... AC	18 - 30Vrms +/- 10%
Current draw	typ. 55mA @ 24VDC PoE Class 1 (0,44 - 3,84W)
Permissible ambient temperatur ...	
... storage	-40 ... +70°C
... operation	0 ... +60°C
Permissible relative humidity	0 ... 95% (not condensing)
Network	10/100BaseT, RJ45 for STP cables
Galvanic Isolation	Network: 1,5kV rms
Dimensions	approx. 105 x 75 x 22mm,
Weight	approx. 150g
Serial ports	1 x RS232/422/485 configurable, DB9/Male
Baud rates	50 bis 230.400 kBit/s
Data formats	7, 8 daten bits, 1, 2 stop bits NO, EVEN, ODD, MARK, SPACE Parity
Flow control	Hardware handshake or Xon/Xoff protocol

Front view
58661, 58665, 58664, 58669

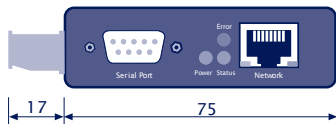

Measure in mm. +/-1mm

Bottom side
58661, 58665, 58664, 58669

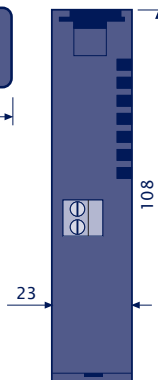

A7 Technical data and formfactor 58662

Supply voltage ...	
Power-over-Ethernet	37 - 57V DC from PSE
External supply...	
... DC	12 - 48V DC (+/- 10%)
... AC	9 - 30Vrms +/- 10%
Current draw	typ. 110mA @ 24VDC
Permissible ambient temperatur ...	
... storage	-40 ... +70°C
... operation, non-cascaded	0 ... +60°C
... operation, cascaded	0 ... +50°C
Permissible relative humidity	0 ... 95% (not condensing)
Network	10/100BaseT, RJ45 for STP cables
Galvanic Isolation	Network: 1,5kV rms
Dimensions	approx. 105 x 75 x 45mm,
Weight	approx. 190g
Serial ports	3 x RS232/422/485 configurable, DB9/Male
Baud rates	50 bis 230.400 kBit/s
Data formats	7, 8 daten bits, 1, 2 stop bits NO, EVEN, ODD Parity
Flow control	Hardware handshake or Xon/Xoff protocol

Front view 58662

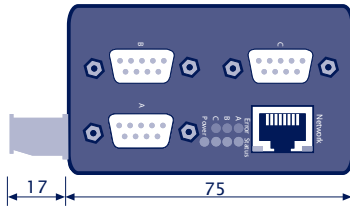

Bottom side 58662

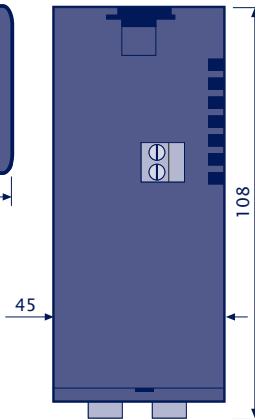

Measure in mm, +/-1 mm

A8 Technical data and formfactor 58664

Supply voltage ...	
Power-over-Ethernet	37 - 57V DC from PSE
External supply...	
... DC	12 - 48V DC (+/- 10%)
... AC	18 - 30Vrms +/- 10%
Current draw	typ. 90mA @ 24VDC PoE Class 1 (0,44 - 3,84W)
Permissible ambient temperatur ...	
... storage	-40 ... +70°C
... operation	0 ... +60°C
Permissible relative humidity	0 ... 95% (not condensing)
Network	10/100BaseT, RJ45 for STP cables
Galvanic Isolation	Network: 1,5kV rms
Dimensions	approx. 105 x 75 x 22mm,
Weight	approx. 150g
Serial ports	1 x 20mA/TTY, DB9/Male
Baud rates	50 bis 19.200 kBit/s
Data formats	7, 8 daten bits, 1, 2 stop bits NO, EVEN, ODD, MARK, SPACE Parity
Flow control	Xon/Xoff protocol, No handshake

Front view
58661, 58665, 58664, 58669

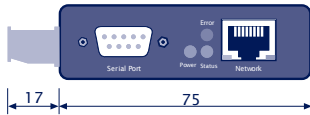

Measure in mm. +/-1mm

Bottom side
58661, 58665, 58664, 58669

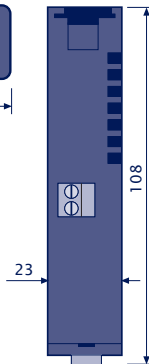

Index**Symbole**

2-wire bus 39
 4-wire bus 39
 20mA interface 41, 74, 231

A

A&E 185
 APPE 151
 ASCII 145
 Auto Negotiation 32

B

Baud Divisor 74
 baud rate 200
 BOX_CNTRL 200

C

Cable Type 61
 Certificate 57
 Certificate Chain 58
 Certificate management 56
 Clear Port Mode 194
 COM_ERROR 198
 COM redirector 127
 COM_STAT 198
 connection status 192
 Connection Timeout 155
 control port 196
 Controlport 81
 CTS 75, 77

D

DA 3.0 185
 data bits 200
 default certificate 56
 DHCP 17, 63
 DHCP Client 63
 Disconnect Char

102, 118, 165
 DNS 63
 DNS Server 63
 DNS-Server 63
 DNS status 192
 DSR 75, 77
 DTR 75, 76, 202

E

Easyterm 224
 Encryption 138
 Endsequence 85
 Error State 193

F

Factory Defaults 69
 firmware update 213
 Fixed Packet Length 91
 fixed routes 62
 flashing patterns 44
 Flash Update 69
 Flow Control 77
 formfactor 229
 framing error 45
 Framing Error 193
 FTP-Client 148
 FTP Client Login 150
 Full Duplex 32

G

Gateway 62, 225
 GET 145

H

Half Duplex 32
 Handshake 76
 handshake lines 198
 Handshake Special 76
 Hardware Handshake 75
 HARDW Rev. 61
 HTTPS 53

Hyperterminal 226

I

IMAGE 145
Inactivity Timeout 154, 165
InQueue 79
InQueueCopy 188
Install Certificate 58
Interpacket Delay 90
IP address 13, 62, 224
IP address conflict 25, 44

K

keep alive 65
keep alive check 65
Keep Alive Time 65

L

Lease time 18
Link speed 69
Link status 32
LIST 151
Local Copy Port 189
Local Port 81
Logfile 67

M

MAC address 20, 61
Master port 137
MTU 63

N

Network Delay 71
No halt on XOFF/RTS/DTR
193

NO Handshake 74, 76

O

OPC server 179
OPC-Server 179
OPC variables 185

P

parity 74, 200
parity error 45
Pin assignment 37
Port State 192
PUT 145

Q

QUIT 145

R

Receive-Filter 78
Reset Com-Server 64
Reset Port Status 82
Reset via configuration 69
Response Mode 106
RETR 151
Retransmission Timeouts 65
RJ45 32
RS232 37
RS232 interface 37
RTS 75, 76, 202
Run Time 61

S

Serial IP assignment 224
Show Connection 77
Slave IP-Address 137
Slave Port 137
SLIP-Net Routing 171
SLIP-Router 170
SNMP 67

Software Handshake 76
SOFTW Date/Rev. 61
SSL 138
Startsequence 85
Startsequence + Lengthfield
88
stop bits 74, 200
STOR 151
Subnet Mask 24, 62, 225
System Name 18, 67
System Options 71
System Password 66
System Port List 64

T

Technical data 229
Telnet-Client 164
Telnet configuration 64
Terminating 39
TLS 138
TTY interface 41, 74, 231
TYPE A 150
TYPE I 150

W

Wake on LAN 65
WuTility 14, 227

X

XON/XOFF 77
XON/XOFF (Filter) 78

Z

Zertifikatsmanagement 56