

# Manual

## Com-Server Highspeed

The logo for W&T, consisting of the letters 'W&T' in a bold, white, sans-serif font, centered within a solid black rectangular box.

**Release** 2.12, May 2008

Type 58631, 58641,  
58651, 58633,  
58031, 58034,  
58231, 58431,  
58432, 58331,  
58334

Com-Server Firmware 1.58 or higher

**W&T**

© 04/2008 by Wiesemann und Theis GmbH  
Microsoft, MS-DOS, Windows, Winsock and Visual Basic  
are registered trademarks of the Microsoft Corporation.

ST is a registered trademark of AT&T Lightguide Cable  
Connectors.

Subject to error and alteration:

Since it is possible that we make mistakes, you mustn't use  
any of our statements without verification. Please, inform us  
of any error or misunderstanding you come about, so we can  
identify and eliminate it as soon as possible.

Carry out your work on or with W&T products only to the  
extent that they are described here and after you have  
completely read and understood the manual or guide. We are  
not liable for unauthorized repairs or tampering. When in doubt,  
check first with us or with your dealer.

**Introduction**

The Com-Server models 58631, 58641, 58651, 58633, 58031, 58034, 58231, 58431, 58432 58331 and 58334 represent a uniform platform for linking serial interfaces such as RS232, RS422/485 to TCP/IP networks.

In addition to all the standard applications implemented in the Com-Servers, this reference manual also describes methods of integrating Com-Servers into your own applications.

**Com-Server Highspeed models**

<b>Model No.</b>	<b>Network interface</b>	<b>Supply voltage</b>	<b>Serial interface</b>	<b>Housing</b>
58631	10/100BaseT autosensing	12 - 24V AC/DC	1 x Interface module RS232/RS422/RS485	Top hat rail housing
58631/UL	10/100BaseT autosensing	12 - 24V DC	1 x Interface module RS232/RS422/RS485	Top hat rail housing
58641	10/100BaseT autosensing	PoE or 24V AC/DC	1 x Interface module RS232/RS422/RS485	Top hat rail housing
58633	10/100BaseT autosensing	12 - 24V AC/DC	3 x Interface module RS232/RS422/RS485	Top hat rail housing
58031	10/100BaseT autosensing	100-250V~ 50-60Hz	1 x Interface module RS232/RS422/RS485	Desktop metal housing
58034	10/100BaseT autosensing	100-250V~ 50-60Hz	4 x Interface module RS232/RS422/RS485	Desktop metal housing
58231	10/100BaseT autosensing	5V +/-5%	1 x Interface module RS232/RS422/RS485	Compact metal housing
58431	10/100BaseT autosensing	5V +/-5%	1 x TTL (optional RS232, RS422/485)	none (OEM)
58432	10/100BaseT autosensing	5V +/-5%	1 x TTL + RS485 2-wire (optional RS232, RS422)	none (OEM, credit card format)
58331	10/100BaseT autosensing	5V +/-5%	1 x Interface module RS232/RS422/RS485	19" version
58334	10/100BaseT autosensing	5V +/-5%	4 x Interface module RS232/RS422/RS485	19" version
58651	100BaseFX	12 - 24V AC/DC	1 x Interface module RS232/RS422/RS485	Top hat rail housing

## Content

<b>1 Quickstart</b>	<b>9</b>
1.1 Flow chart – Network installation using WuTility	10
1.2 Overview of configuration menu	11
1.3 Factory Default settings	12
<b>2 Assigning the IP address</b>	<b>13</b>
2.1 Configuring network parameters with WuTility	14
2.2 Assigning the IP using the ARP command	18
2.3 Serial assigning of IP, subnet mask and gateway	20
2.4 Assigning the IP using DHCP protocol	24
2.4.1 Activating/Deactivating DHCP	24
2.4.2 System Name	25
2.4.3 Lease-Time	26
2.4.4 Reserved IP addresses	27
2.4.5 Dynamic IP addresses	27
2.5 Assigning the IP using BOOTP protocol	28
2.5.1 Address reservation	28
2.6 Assigning the IP using a RARP server	30
<b>3 Form factors</b>	<b>31</b>
3.1 Com-Server Highspeed Industry	32
3.2 Com.Server Highspeed Isolated 58633	33
3.3 Com-Server Highspeed Office	34
3.4 Com-Server Highspeed 19"	35
3.5 Com-Server Highspeed OEM 58431	36
3.6 Com-Server Highspeed compact 58231	37
3.7 Com-Server Highspeed 100BaseFX	38
<b>4 Supply voltage</b>	<b>39</b>
4.1 Com-Server Highspeed Industry and Isolated	40
4.2 Com-Server Highspeed Industry 58631/UL	41
4.3 Com-Server Highspeed Industry PoE	42
4.4 Com-Server Highspeed 100BaseFX	43
4.5 Com-Server Highspeed Office	44
4.6 Com-Server OEM and compact	45
4.7 Com-Server Highspeed 19"	46

<b>5</b>	<b>Interfaces and displays</b>	<b>49</b>
5.1	Ethernet connection	50
5.1.1	10/100BaseT on RJ45	50
5.1.2	100BaseFX with ST	52
5.2	RS232/422/485 combi-module	54
5.2.1	Opening the Com-Server	54
5.2.2	Mode selection	55
5.2.3	RS232 mode (factory default)	55
5.2.4	RS422/485 mode	57
5.3	Interface for the OEM-Com-Server 58431	60
5.4	Option: 20mA interface	62
5.5	Interfaces for the OEM-Com-Server 58432	64
5.5	LED displays	67
<b>6</b>	<b>Configuration access to the Com-Server</b>	<b>69</b>
6.1	Configuration menu structure	70
6.2	Configuration via Telnet	72
6.3	Configuration via Browser - Web Based Management	75
6.3.1	Activating WBM with the WuTility-Tool	75
6.3.3	Activating WBM from the configuration menu	77
6.3.3	Starting and navigating the WBM	77
<b>7</b>	<b>The basis configuration of the Com-Server</b>	<b>81</b>
7.1	Saving your settings	82
7.2	Menu: INFO System	83
7.3	Menu: SETUP System	84
7.3.1	Menu: SETUP System → Setup TCP/IP	84
7.3.2	Menu: SETUP System → Telnet Password (obsolete)	87
7.3.3	Menu: SETUP System → System Password	88
7.3.4	Menu: SETUP System → System Name	89
7.3.5	Menu: SETUP System → Flash Update	89
7.3.6	Menu: SETUP System → Factory Defaults	90
7.3.7	Menu: SETUP System → Reset	90
7.3.8	Menu: SETUP System → Link Speed	90
7.4	Menu ... → TCP/IP Mode → System Options	92

# W&T

<b>8 Configuration of the serial port</b>	<b>95</b>
8.1 The serial parameters (Menu: UART Setup)	96
8.1.1 Baud rate, Data bits, stop bits, parity	96
8.1.2 The handshake modes	97
8.1.3 FIFO Send/Rec	101
<b>9 The protocol stack of the Com-Server</b>	<b>103</b>
9.1 Services of the Com-Server	104
9.2 Addressing in the TCP/IP Network	105
9.3 The protocol stack of the Com-Server	106
<b>10 Data transfer per TCP/IP sockets</b>	<b>109</b>
10.1 The Com-Server as TCP server	110
10.1.1 Configuration of the local port number	110
10.1.2 Optional settings	111
10.2 The Com-Server as TCP-Client	113
10.2.1 TCP client mode with fixed destination system	114
10.2.2 TCP client mode with serial addressing	117
10.2.3 Optional settings	118
10.2.4 Deactivating TCP client mode	120
<b>11 Data transfer per UDP</b>	<b>123</b>
11.1 The Com-Server as UDP peer	124
11.1.1 Setting the local UDP port number	125
11.1.2 UDP clientmode with fixed destination system	126
11.1.3 UDP client mode with serial addressing	127
11.1.4 Optional settings	129
11.1.5 Deactivating UDP mode	130
<b>12 The Windows COM port redirector</b>	<b>131</b>
12.1 Overview	132
12.2 Download & installation of the W&T COM redirector	133
12.3 Einrichtung virtueller COM-Ports	135
<b>13 Box-to-Box mode</b>	<b>137</b>
13.1 Box-to-Box mode	138
13.1.1 Configuring Box-to-Box mode	139
13.1.2 Optional settings	140
13.1.3 Deactivating Box-to-Box mode	140

# W&T

<b>14 Data transfer per FTP</b>	<b>143</b>
14.1 The Com-Server as FTP server	144
14.2 The Com-Server as FTP client	146
14.2.1 Configuring the destination address and port no.	146
14.2.4 Deactivating FTP client mode	153
14.2.5 Application examples	153
<b>15 Data transfer per Telnet</b>	<b>155</b>
15.1 Com-Server as Telnet server	156
15.2 The Com-Server as Telnet client	157
15.2.1 Optional settings	159
15.2.2 Deactivating Telnet client mode	159
<b>16 IP Bus mode</b>	<b>161</b>
16.1 Function of the IP Bus mode	162
16.2 Configuring the IP Bus mode	163
16.2.1 Activating the master	163
16.2.3 Deactivating IP Bus Mode	164
<b>17 The Com-Server as SLIP router</b>	<b>165</b>
17.1 Configuring the SLIP mode	166
17.1.1 Deactivating SLIP router mode	167
17.1.2 Application example	168
17.1.3 Configuring the Com-Server via SLIP	169
<b>18 Serial Socket Interface</b>	<b>171</b>
18.1 Serial Socket Interface	172
<b>20 OPC data transfer</b>	<b>173</b>
19.1 Überblick	174
19.2 Download and installation of the W&T OPC server	175
19.2.1 Installation/deinstallation of the W&T OPC server	175
19.2.2 Deinstallation of the OPC server	176
19.3 Configuration of the OPC server	177
19.3.1 Einstellungen am Com-Server	177
19.3.2 Einbindung des Com-Servers in den OPC-Server	178
19.3.3 Strukturierung der seriellen Daten	179
19.4 Serial OPC variables	180

# W&T

<b>20 Status and error messages</b>	<b>181</b>
20.1 Menu Setup Port x → Port State	182
<b>21 Expanded services of the Com-Server</b>	<b>185</b>
21.1 The control port	186
21.2 Reset Com-Server-Port	194
21.3 Software reset of the Com-Server	196
21.4 Uploading/downloading configuration data	197
21.5 Inventory taking per UDP/8513	199
21.6 SNMP management	202
<b>22 Firmware update of the Com-Server</b>	<b>203</b>
22.1 Where do I get the current firmware?	204
22.2 Network firmware update under Windows	205
22.3 Network firmware update under UNIX	206
<b>Appendix</b>	<b>209</b>
TCP/IP under Windows 9x	210
TCP/IP under Windows NT	211
Used ports and network security	212
Serial assignment of the IP address under Windows	216
Web application HTTP, SMTP, POP3 ...	220
WuTility - Inventory and management tool	222
Hardware reset to factory defaults	223
Technical Data	224
Com-Server Highspeed Industry 58631	224
Com-Server Highspeed Isolated 58633	225
Com-Server Highspeed PoE 58641	226
Com-Server Highspeed 100BaseFX 58651	227
Com-Server Highspeed Office 58031, 58034	228
Com-Server Highspeed 19" 58331, 58334	229
Com-Server Highspeed OEM 58431	230
Com-Server Highspeed Compact 58231	231
<b>Index</b>	<b>233</b>



# **1 Quickstart**

Already experienced users of Com-Servers will find on the two following pages a flow chart with the essential steps for start-up as well as a complete overview of the configuration menu. Detailed information can be found then in the following sections.

1.1 Flow chart - Network installation using WuTility

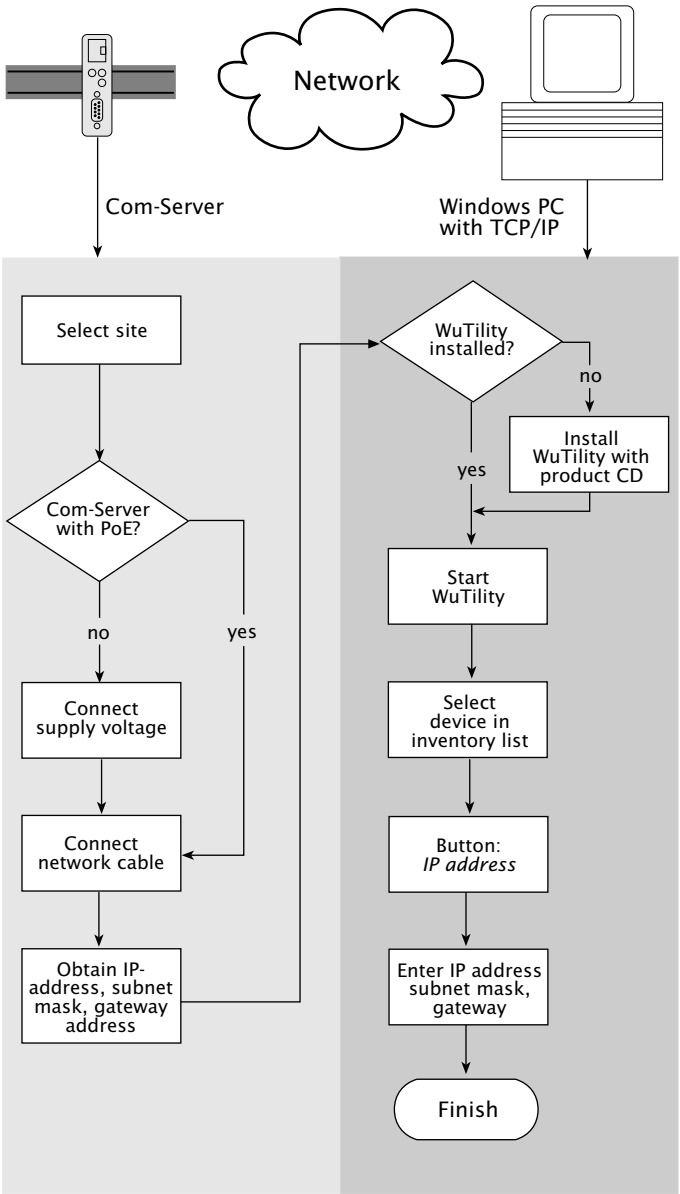

**1.2 Overview of configuration menu**

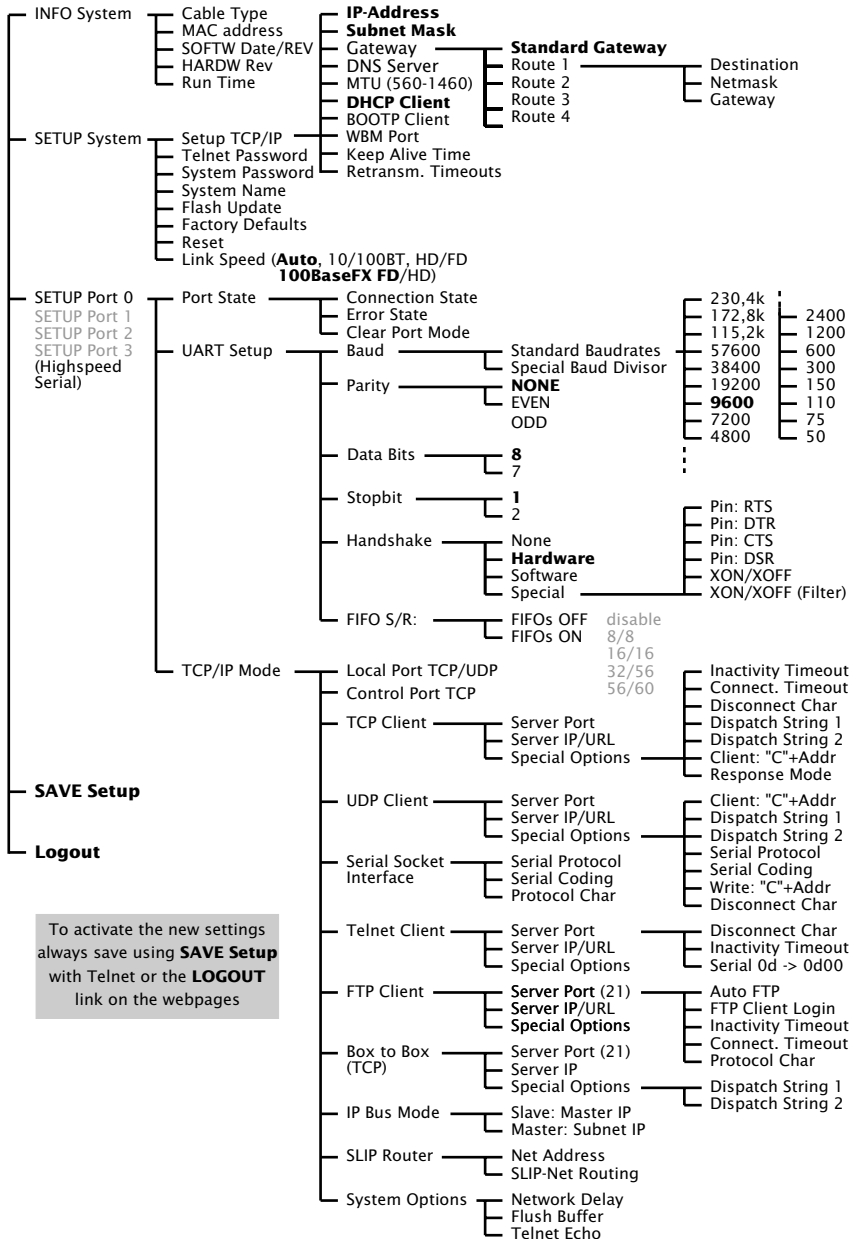

To activate the new settings always save using **SAVE Setup** with Telnet or the **LOGOUT** link on the webpages

## 1.3 Factory Default settings

The list contains an overview of the most important settings. For many applications, such as the W&T COM Port Redirector, no additional configurations need to be made besides assigning the network base parameters. Detailed information on the respective parameters can be found in later sections of this manual.

### Network settings

Hardware connection:	Auto negotiating
IP address:	0.0.0.0
Gateway address:	0.0.0.0
Subnet mask:	255.0.0.0
DNS server:	0.0.0.0
DHCP:	Active



*To prevent unintended address assignments or changes, we recommend deactivating the DHCP, BOOTP and RARP protocols if they are not expressly used in the respective network environment.*

### Serial settings

Hardware connection:	RS232
Baud rate:	9600
Data bits:	8
Parity:	NO
Stop bits:	1
Handshake:	Hardware (RTS/CTS)
FIFO:	OFF

### Configuration access

Per Telnet using TCP port 1111

### Network applications/Operating modes

TCP sockets (Port A...D):	8000, 8100, 8200, 8300
Telnet (Port A...D):	6000, 6100, 6200, 6300
FTP (Port A...D):	7000, 7100, 7200, 7300

## **2 Assigning the IP address**

The Com-Server is factory set to IP address 0.0.0.0. Before you can make the entry in the Com-Server, you need to specify an IP address that is valid for your network. Your system administrator will provide you with this. If you have only a small network with no routing, use the IP address of your PC and simply change the last digit. The IP address must be unique within the network!

- Assigning IP address, subnet mask and gateway address using *WuTility* management tool
- Using the ARP command
- Assigning IP address, subnet mask and gateway address through the serial port
- Using the RARP protocol
- Assigning IP address, subnet mask and gateway using DHCP/BOOTP protocol

## 2.1 Configuring network parameters with *WuTility*

The Windows tool WuTility version 3.0 and higher allows not only inventorying of Com-Server and Web-IO installations, but also convenient assignment of the following network-side basic parameters:

- IP address
- Subnet mask
- Gateway address
- Activating/deactivating BOOTP/DHCP
- Activating/deactivating Web-Based-Management

Assigning requires that the PC and Com-Server be in the same subnet. In firmware revision 1.45 the function is independent of the current address settings in the Com-Server, i.e. even changes to parameters not matching the network are easily made. Any system password which has been set must however in this case be known.

### **Downloading and installing *WuTility***

The most current version can always be found at our Web site under the following address:

<http://www.wut.de>

From there use the menu tree on the left side to navigate:

*Products & Downloads* → *Com-Servers* → *Software Tools*

After unzipping the ZIP file, begin installation by double-clicking on the file `setup_us.exe`. WuTility is started from

*Start* → *Programs* → *W&T Software Toolkit* → *WuTility*

### **Starting the assignment dialog**

First be sure that both the Com-Server and the computer you are using are connected to the same network and are in the same subnet. When started, WuTility automatically searches the

local network for connected W&T network devices and creates an inventory list. This search process can be repeated manually as often as desired by clicking on the Scan button:



Within the inventory list you can identify the desired Com-Server based on its MAC address. For initial installations its IP address is 0.0.0.0.



Select the Com-Server and click on the *IP address* button:



Enter the desired values for IP address, subnet mask and gateway address in the corresponding fields and then click on the *Next* button.

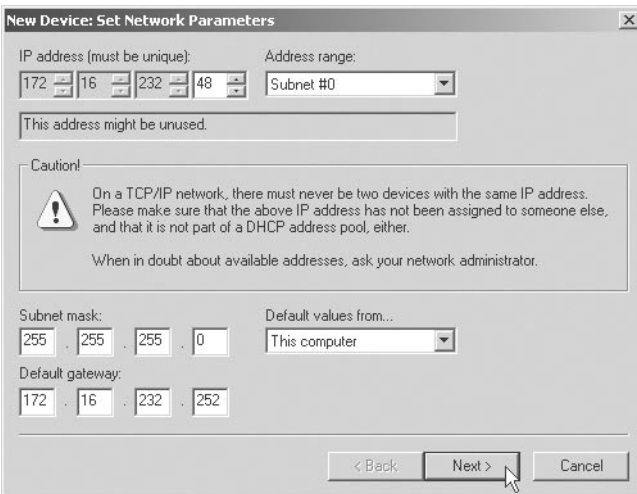

In the following window you can activate the DHCP client and the Web-Based-Management of the Com-Server.

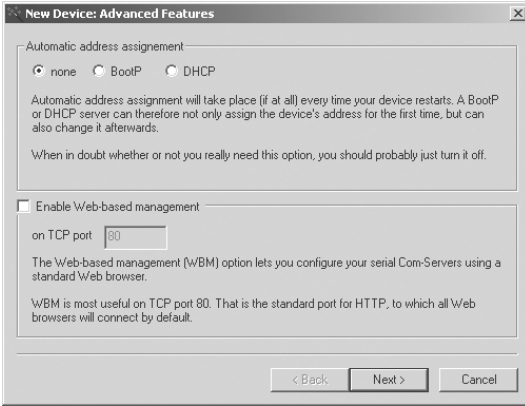

*To prevent unintended address assignments or changes, we recommend deactivating the DHCP, BOOTP and RARP protocols if they are not expressly used in the respective network environment. Com-Servers with incorrectly assigned IP addresses can be easily found after the fact using the scan function of the WuTility management tool and reconfigured.*

Clicking on the *Next* button assigns the network parameters to the Com-Server. All columns in the WuTility device list are filled with information.

This concludes the network-side startup of the Com-Server, and for many applications – such as use together with the COM Port Redirector – no further settings are necessary. Special modes or serial parameters can be set using the telnet configuration menu or, if Web-Based-Management was used, with the help of the Internet browser. To do this, click on either the *Telnet* or *Browser* button:

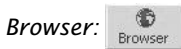
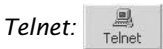





*Changing network parameters is protected by the system password. To prevent improper access, we recommend assigning a system password for any Com-Servers in use.*

Additional information can be found in the section *Configuration Accesses for the Com-Server*.

## 2.2 Assigning the IP using the ARP command



*This method can only be used if the Com-Server does not already have an IP address, i.e. the entry is 0.0.0.0. To change an IP address, use one of the other methods described in this section or use the configuration menu over Telnet.*

Required is a computer which is located in the same network segment as the Com-Server and which has TCP/IP protocol installed. Read off the Ethernet address of the Com-Server from the sticker on the side of the housing:

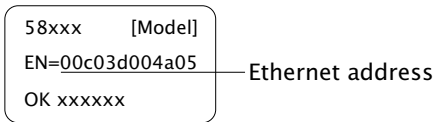

Insert a static entry into the ARP table of the computer using the following command line:

```
arp -s [IP address] [MAC address]
```

e.g. under Windows:

```
arp -s 172.16.231.10 00-C0-3D-00-12-FF
```

e.g. under SCO UNIX:

```
arp -s 172.16.231.10 00:C0:3D:00:12:FF
```

Next use the following command line under *Start* → *Run* to start a Telnet session on the configuration port of the Com-Server with the desired IP address:

```
telnet 172.16.232.10 1111 [Return]
```



*The IP addresses must be without leading zeros in all Windows environments. Otherwise the entry is incorrectly interpreted by the system and an incorrect IP address is assigned to the Com-Server.*



*The IP address must be unique within the network.*



*Older Windows systems only accept a static entry if there is a dynamic one already present. Here you should first ping another network station.*

The Com-Server takes the IP address of the first network packet sent to it as its own and saves it in non-volatile memory. The Telnet connection will be established and the configuration menu is displayed in the Telnet window. All further settings are made here (see *Basic configuration of the Com-Server*).

### 2.3 Serial assigning of IP, subnet mask and gateway

After a Com-Server reset a time window of around 1-2 seconds is available, during which you can assign a new IP address, subnet mask and gateway address by entering at least 3 „x“.



*In contrast to the ARP method described above, this serial method functions regardless of whether the Com-Server already has an IP address or not. The procedure can be repeated as often as desired. Therefore use this method if you don't know the IP address or have forgotten it. Appendix D contains the detailed procedure under Windows using HyperTerminal.*

First connect the serial port A of the Com-Server to a computer. For a standard PC or laptop, you will need a *crossed* RS232 cable (=Null modem cable, see *RS232 interface*).

The serial transmission parameters of the terminal program you use should be set to *9600 baud, no parity, 8 bits, 1 stop bit*, no handshake. Reset the Com-Server by interrupting the power. When the green status LED lights up, enter the letter „x“ at least three times on the terminal, until the Com-Server returns the prompt *IPno.+<Enter>*.

Use the usual format (xxx.xxx.xxx.xxx) to enter the IP address, and end the entry by pressing <Enter>. If the entry was accepted, the acknowledgement is the assigned IP address. Otherwise you will get a *FAIL* message followed by the last current IP address.

All other settings such as gateway address, subnet mask etc. are done through the Telnet configuration menu (see *Basic configuration of the Com-Server*).

### 2.3.1 Assigning of subnet mask and gateway address

Together with the IP address, the subnet mask and gateway address can also be assigned serially. The entry is separated by commas and follows the IP address. Entering as shown in the following example will assign IP address 172.17.231.99, subnet mask 255.255.255.0 and gateway 172.17.231.52 to the Com-Server

```
IP no. +<ENTER>:          <- Com-Server
172.17.231.99,255.255.255.0,172.17.231.52  -> Com-Server
172.17.231.99 ,255.255.255.0,172.17.231.52-1 <- Com-Server
```

### 2.3.2 Deactivating DHCP/BOOTP/RARP

The DHCP/BOOTP/RARP function of the Com Server can be turned off as part of assigning the IP address serially. We recommend making use of this at all times except where use of DHCP, BOOTP or RARP is expressly required. To deactivate the DHCP/BOOTP/RARP client enter the option „-0“ (zero) directly appended (no space!) to the IP address and confirm with <Enter>.



*An explanation of the basic terms and concepts for addressing in the internet and using DHCP and BOOTP can be found in our manual TCP/IP-Ethernet and Web-IO.*

- **-0**  
DHCP, BOOTP and RARP = OFF
- **-1**  
DHCP = OFF,  
BOOTP and RARP = ON
- **-2**  
DHCP = ON  
BOOTP and RARP = OFF

*Example:* Deactivation of DHCP, BOOTP and RARP

```
xxx          -> Com-Server
IP no. +<ENTER>: <- Com-Server
172.17.231.99-0  -> Com-Server
172.17.231.99   <- Com-Server
```

This function can later be reactivated through the Telnet configuration under *SETUP System → SETP TCP/IP → BOOTP Client*.



*To prevent unintended address assignments or changes, we recommend deactivating the DHCP, BOOTP and RARP protocols if they are not expressly used in the respective network environment. Com-Servers with incorrectly assigned IP addresses can be easily found after the fact using the scan function of the WuTility management tool and reconfigured.*

### 2.3.3 Serial activation of Web Based Management

To further configure the Com-Server you can use either Telnet protocol or an Internet browser, although only Telnet is an option in the Com-Server as shipped from the factory. You can activate Web Based Management as part of the serial IP assignment. To do this, enter *+w[Portno.]* directly after the IP address or address string. Here *Portno.* is the desired TCP port in decimal format.

*Example 1: Deactivating DHCP/BOOTP/RARP and activating Web Based Management on TCP port 8080.*

```
xxx                                     -> Com-Server
IP no.+<ENTER>:                         <- Com-Server
172.17.231.99,255.255.0.0,172.17.231.52-0+w8080  -> Com-Server
172.17.231.99,255.255.0.0,172.17.231.52-0+w8080  <- Com-Server
```

*Example 2: Activation of Web Based Management on TCP port 80. The status of DHCP/BOOTP/RARP remains unchanged.*

```
xxx                                     -> Com-Server
IP no.+<ENTER>:                         <- Com-Server
172.17.231.99+w80  -> Com-Server
172.17.231.99-1   <- Com-Server
```



*For additional information on activating Web Based Management, see section Configuration via Browser Web Based Management.*

## 2.4 Assigning the IP using DHCP protocol

Many networks use DHCP (Dynamic Host Configuration Protocol) or its predecessor described in the following section for centralized and dynamic assignment of the network parameters. DHCP protocol is activated by the factory default settings, so that in network environments dynamic IP assignment is sufficient for connecting the Com-Server to the network. The following parameters can be assigned using DHCP:

- IP address
- Subnet mask
- Gateway address
- DNS server
- Lease time



*To prevent unintended address assignments or changes, we recommend deactivating the DHCP, BOOTP and RARP protocols if they are not expressly used in the respective network environment. Com-Servers with incorrectly assigned IP addresses can be easily found after the fact using the scan function of the WuTility management tool and reconfigured.*

### 2.4.1 Activating/Deactivating DHCP

The factory default setting is for DHCP protocol active. To deactivate it or to enable it again later, use one of the following options.

- **Management-Tool WuTility**

Select the desired Com-Server in the device list and click on the IP Address button. In the first dialog box enter the newly assigned network parameters and then click on Continue. In the following dialog BOX deactivate the options BOOTP and DHCP.



Clicking on Continue then sends the new configuration data to the Com-Server.

- **Serial port**

As part of serial IP assignment, the following options for deactivating/activating DHCP and BOOTP can be selected directly following the address string:

- 0 → Deactivates DHCP and BOOTP
- 1 → Activates BOOTP/RARP
- 2 → Activates DHCP

A detailed description of the procedure can be found in the section on *Serial assignment of IP, subnet mask and gateway*.

- **Telnet or Web Based Management**

From the menu branch *SETUP System → Setup TCP/IP → DHCP/BOOTP Client* the protocols can be alternately activated and both deactivated. For detailed information refer to the section *Menu: SETUP System*.

## 2.4.2 System Name

To support any automatic updating of the DNS system by the DHCP server, the Com-Server identifies itself within the DHCP protocol with its system name. The factory default setting for this is *COMSERVER\_* followed by the last three places of the Ethernet address. For example the factory set system name of a Com-Server with the Ethernet address 00:c0:3d:01:02:03 is *COMSERVER\_010203*. The system name of the Com-Server can be changed in the configuration. For additional information refer to the section *Menu: SETUP System → System Name*.

### 2.4.3 Lease-Time

The lease time determined and transmitted by the DHCP server specifies the Time-To-Live of the assigned IP address. After half the lease time has expired, the Com-Server attempts to extend the time for the assigned DHCP server and up update the address. If this is not possible by the time the lease time expires, for example because the DHCP server can no longer be reached, the Com-Server deletes the IP address and starts a new cyclical search for alternate DHCP servers for the purpose of assigning a new IP address.

Because of the absent clock, the lease time associated with the current IP address is no longer available after a reset. After the restart therefore a corresponding update request is issued with the original DHCP server. If the latter is not resolvable at this point in time, the Com-Server deletes the IP address and starts a new cyclical search for alternate DHCP servers.

If DHCP is activated, the remaining lease time together with the current IP address is displayed in the menu item *SETUP System* → *Setup TCP/IP* → *IP-Address* using the format hh:mm:ss.



*If after the assigned lease time has expired the DHCP server is not reachable, the Com-Server deletes its IP address. All existing TCP/UDP connections between the Com-Server and other network clients are thereby closed. To prevent such events, we recommend configuring the assigned lease time in the DHCP server to infinite if possible.*

### 2.4.4 Reserved IP addresses

If the Com-Server is used as a TCP server or UDP peer, it provides services which other clients in the network can also make use of as needed. To open a connection, they of course need the current IP address for the Com-Server, so that in such situations it makes sense to reserve a particular IP address for the Com-Server on the DHCP server. This is generally done by linking the IP address to the unique Ethernet address of the Com-Server, which can be found on the sticker attached to the housing.

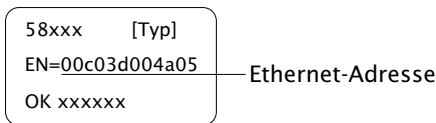

### 2.4.5 Dynamic IP addresses

Fully dynamic address assignment, whereby the Com-Server gets a different IP address every time it is restarted or after the lease time has expired, only makes sense in network environments with automatic cross-connection between the DHCP and DNS services. This means when a new IP address is assigned to the Com-Server, the DHCP server then automatically updates the DNS system as well. The new address is associated with the respective domain name. If in doubt, consult your system administrator for detailed information about your network environment.

If the Com-Server is configured as a TCP or UDP client and itself actively searches for a connection to server services in your network, dynamic changing IP addresses may be used.

## 2.5 Assigning the IP using BOOTP protocol

Many networks use BOOTP as predecessor of DHCP protocol for centralized and dynamic assignment of IP addresses. The factory default setting is for BOOTP turned off. You can activate it from *SETUP System* → *SETUP TCP/IP* → *BOOTP Client*. The following parameters can be assigned:

- IP address
- Subnet mask
- Gateway address
- DNS server



*To prevent unintended address assignments or changes, we recommend deactivating the DHCP, BOOTP and RARP protocols if they are not expressly used in the respective network environment. Com-Servers with incorrectly assigned IP addresses can be easily found after the fact using the scan function of the WuTility management tool and reconfigured.*

### 2.5.1 Address reservation

BOOTP protocol is based on fixed reservations of fixed IP addresses for particular Ethernet addresses. This means a Com-Server connected to the network only gets an IP address if the latter was previously stored in the BOOTP server. Check with your system administrator for creating this reservation. The Ethernet address of the Com-Server can be found on the housing sticker.

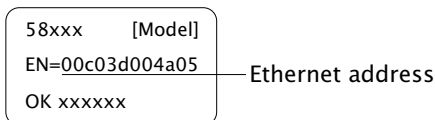

Once the administrator has made the necessary entries, the Com-Server obtains the desired IP address automatically after

each reset. To ensure accessibility of the Com-Server even should the BOOTP server go down, the previous IP address is retained should there be no reply.

## 2.6 Assigning the IP using a RARP server

UNIX environments especially use RARP protocol for centrally assigning IP addresses. TCP/IP devices that want to obtain an IP address send RARP requests with their Ethernet address as a broadcast over the network.

RARP protocol is coupled to BOOTP protocol in the Com-Server. Activate it from *SETUP System* → *SETUP TCP/IP* → *BOOTP Client*.

Activate the RARP server, and enter the Ethernet address of the Com-Server in the file `/etc/ethers` and the IP address in the file `/etc/hosts`.

58xxx	[Model]	
EN=00c03d004a05		— Ethernet address
OK xxxxxx		

The Com-Server must be connected to the network in the same segment as the RARP server.

### Example:

Your Com-Server has the MAC address EN= 00C03D0012FF (sticker on the unit). You want to give it IP address 172.16.231.10 and the alias name WT\_1:

- Entry in the file `/etc/hosts`:  
172.16.231.10WT\_1
- Entry in the file `/etc/ethers`:  
00:C0:3D:00:12:FF WT\_1

 To prevent unintended address assignments or changes, we recommend deactivating the DHCP, BOOTP and RARP protocols if they are not expressly used in the respective network environment. Com-Servers with incorrectly assigned IP addresses can be easily found after the fact using the scan function of the WuTility management tool and reconfigured.

### **3 Form factors**

- Industry model
- Isolated model
- Office models
- 19" models
- OEM models
- Compact model
- 100BaseFX model

### 3.1 Com-Server Highspeed Industry

Front view 58631, 58631/UL, 58641

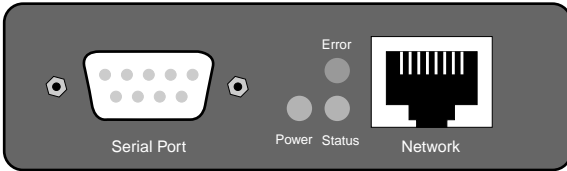

Bottom side 58631, 58631/UL, 58641

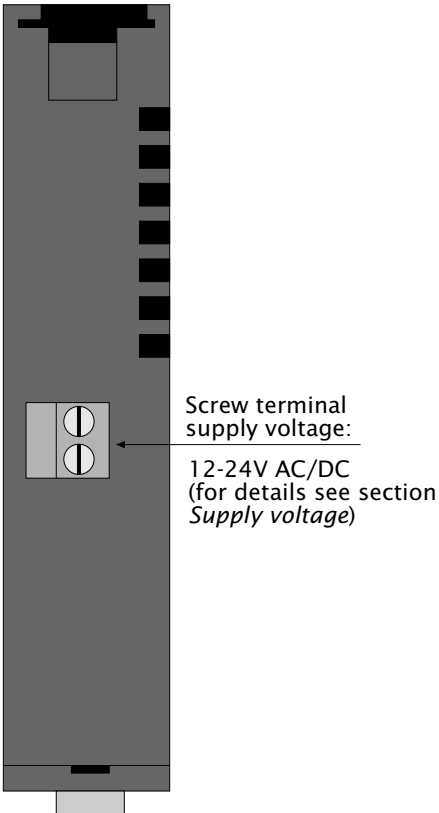



### 3.2 Com-Server Highspeed Isolated 58633

Frontview 58633

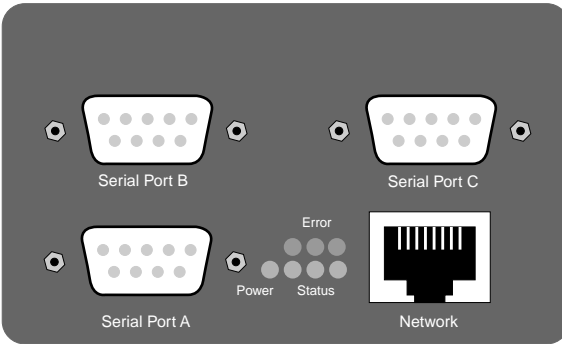

Bottom Side 58633

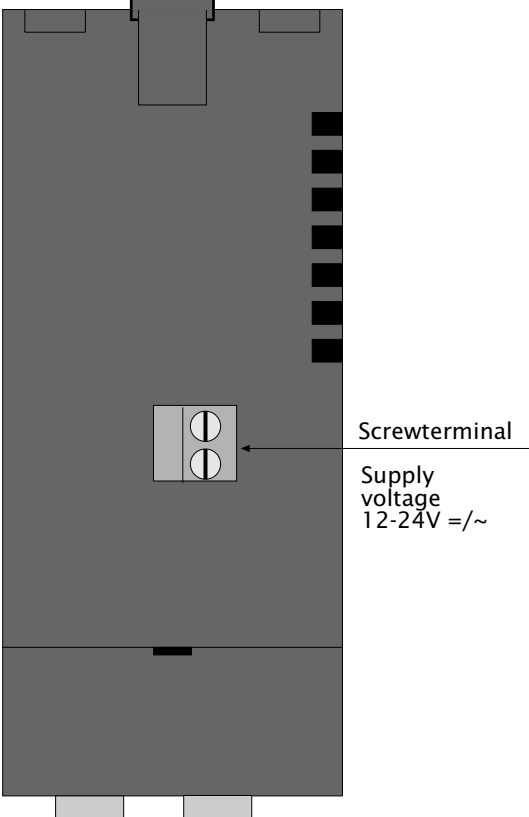

### 3.3 Com-Server Highspeed Office

#### Front view 58031



#### Front view 58034

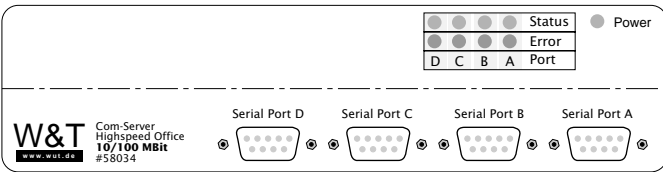

#### Back view 58031, 58034



### 3.4 Com-Server Highspeed 19"

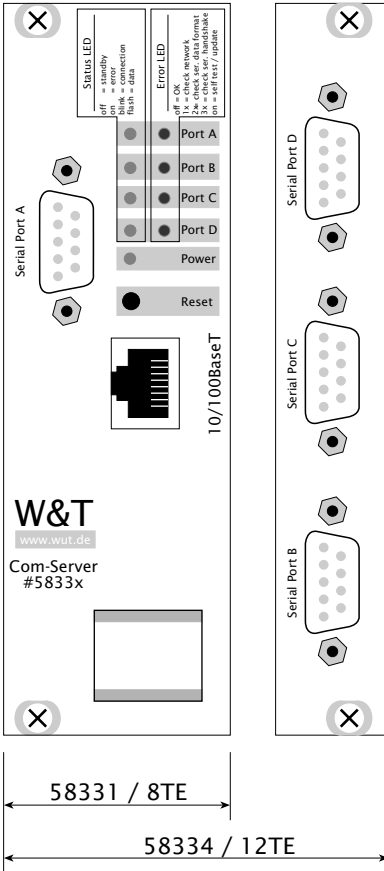

### 3.5 Com-Server Highspeed OEM 58431

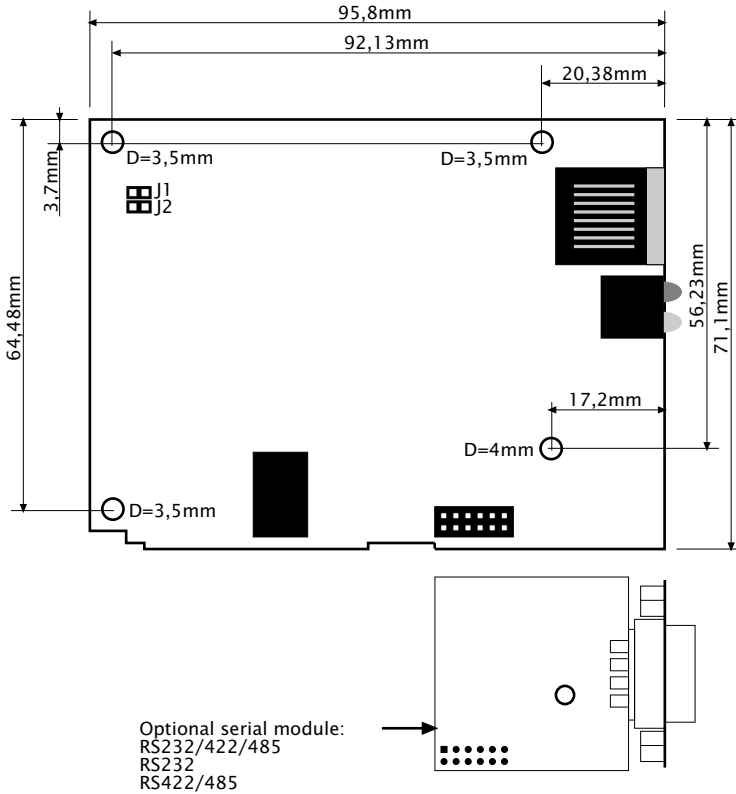

### 3.6 Com-Server Highspeed compact 58231

Frontview

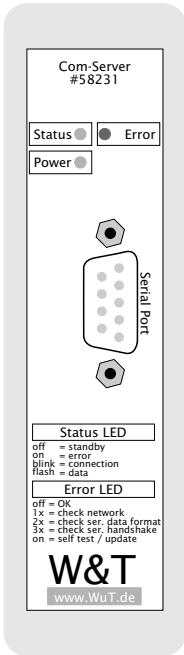

Backview

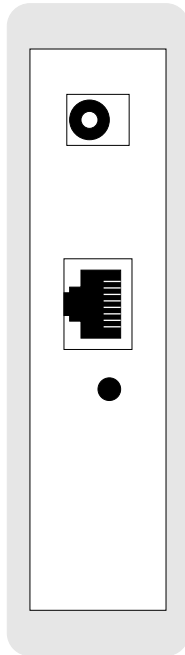

### 3.7 Com-Server Highspeed 100BaseFX

Front view 58651

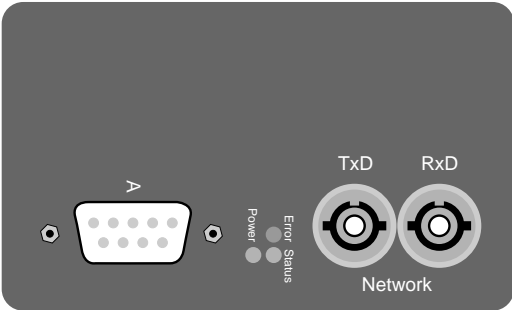

Bottom side 58651

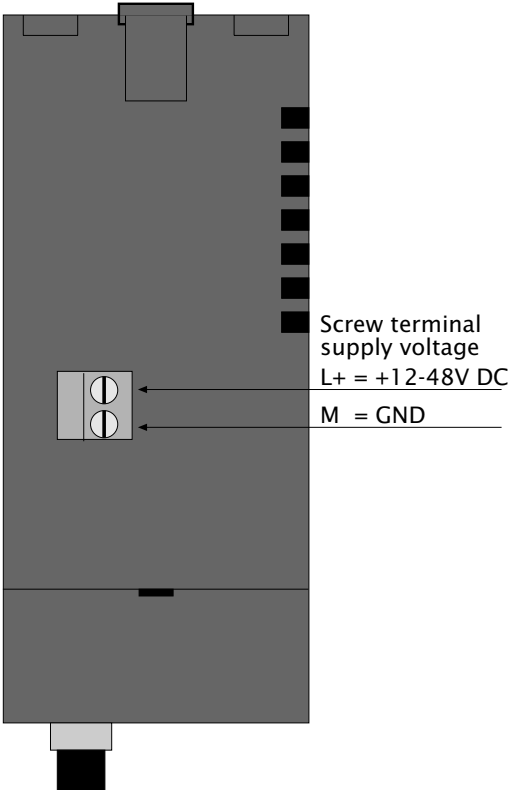

## **4 Supply voltage**

- Industry and isolated model
- PoE - Power over Ethernet
- 100BaseFX model
- Office models
- 19" models
- OEM models
- Compact model

## 4.1 Com-Server Highspeed Industry and Isolated

- **Models: 58631, 58633**

The supply voltage for models 58631 and 58633 can be brought in on the adjacent screw terminals on the underside of the housing. DC voltage of any polarity or AC voltage may be used. The reverse polarity protection results in the following various maximum and minimum values for the supply voltage:

- AC: 9Vrms (- 10%) - 30Vrms (+10%)
- DC: 12V (-10%) - 48V (+10%)

If the supplied AC adapter for office applications is used, the connector pins can be connected to the screw terminals. The current draw of each model is indicated in the technical appendix.

### **Fuse**

The supply voltage for the 58631 Com-Server is protected against overcurrent by an integrated fuse. Since this component is a safety-relevant part, the fuse must be replaced with an identical fuse type by service personell only:

Manufacturer: Littelfuse

Model: Nano SMD Fuse, Series 451

Type: 1A / 125V, Art.-No. 451 001



## 4.2 Com-Server Highspeed Industry 58631/UL

- **Models: 58631/UL**

The supply voltage for model 58631/UL is brought in through a screw terminal located on the bottom of the housing. DC voltage of any polarity may be used. The polarity reversal protection results in the following maximum and minimum values for the supply voltage:

- DC voltage: 12V (-10%) - 24V (+10%)

If the AC adapter supplied is used, the connector pins may be connected to the screw terminals.

When power is provided by a third-party power supply, it must meet the requirements for Limited Power Sources (LPS) in accordance with NEC Class 2. The current draw can be found in the technical appendix.

### **Fuse**

The supply voltage for the 58631/UL Com-Server is protected against overcurrent by an integrated fuse. Since this component is a safety-relevant part, the fuse must be replaced with an identical fuse type by service personell only:

Manufacturer: Littelfuse

Model: Nano SMD Fuse, Series 451

Type: 1A / 125V, Art.-No. 451 001

### 4.3 Com-Server Highspeed Industry PoE

- **Models: 58641**

The model 58641 Com-Server is designed for use in PoE (Power-over-Ethernet) environments in accordance with IEEE802.3af. Power is provided by the network infrastructure using the RJ45 terminal. The Com-Server supports both phantom power using data pairs 1/2 and 3/6 as well as power feed using the unused wire pairs 4/5 and 7/8.

To enable power management for the supplying components, the Com-Server is identified as a Power Class 1 device with a power consumption of 0.44 to 3.84W.

As an alternative to PoE power supply, the 58641 Com-Server can also be powered by an external power supply connected to the screw terminals on the underside of the housing. DC voltage of any polarity as well as AC voltage may be used. This polarity reversal protection results in the following maximum and minimum values for the power supply:

- AC: 18Veff (- 10%) - 30Vrms (+10%)
- Gleichspannung: 24V (-10%) - 48V (+10%)



*Use of the model 58641 Com-Server is also possible in networks without PoE power supply. In this case simply use an external power supply attached to the screw terminal as described above. No additional configurations or settings are necessary.*

## 4.4 Com-Server Highspeed 100BaseFX

- **Models: 58651**

Supply voltage for model 58651 is provided to the screw terminal on the underneath of the housing. A half-wave rectifier makes the input reverse polarity protected. AC or DC power may be used, whereby the following limit values must be observed:

- AC: 18Vrms (- 10%) - 30Vrms (+10%)
- DC: 12V (-10%) - 48V (+10%)

The current draw can be found in the technical appendix.

When powering with DC voltage polarity must be observed. The terminal labeled L+ must be connected to positive voltage. Terminal M is connected to the associated GND.

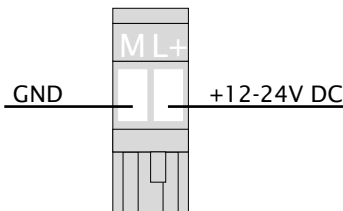

### Fuse

The supply voltage for the Com-Server 58651 is protected against overcurrent by an integrated fuse. Since this component is a safety-relevant part, the fuse must be replaced with an identical fuse type by service personell only:

Manufacturer: Littelfuse

Model: Nano SMD Fuse, Series 451

Type: 1A / 125V, Art.-No. 451 001

## 4.5 Com-Server Highspeed Office

- **Models: 58031, 58034**

The office models 58031 and 58034 include an integrated wide-range power supply for an AC voltage of 100-250V/50-60Hz. Mechanically the connection is made via a cold-device cable.

The current draw of each model is indicated in the technical appendix.

### 4.6 Com-Server Highspeed OEM and compact

- **Models: 58431, 58432, 58231**

#### 58231, 58431

The supply is brought in on a mains receptacle for hollow pin plugs located in the edge of the board. The feed voltage must be  $5V \pm 5\%$ .

Pin jack 5,5mm  
Polarity: inner = GND  
outer = +5V

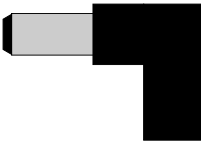

#### 58432

The supply voltage is brought in through one of the two post connectors that are used for the serial signals as well. Supply voltage has to be  $5V \pm 5\%$ .

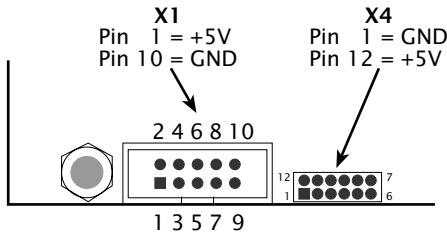

The current draw is indicated in the technical appendix.

### 4.7 Com-Server Highspeed 19"

- **Models: 58331, 58334**

The Com-Server Highspeed 19" models get their supply voltage through the 96-pin VG connector:

Component side of board

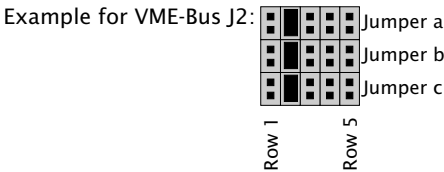
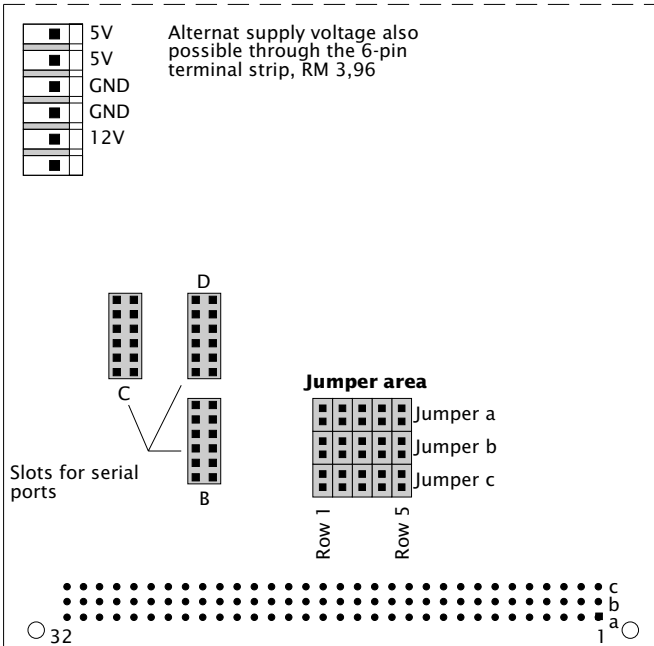

Use the following table to determine how jumpers a-c in the corresponding row depending on which bus system is used.

Jumper	Pin VG strip			Com-Server			Standard (all three jumpers of row closed)
	A	B	C	A	B	C	
Row 1	9c	32c	31c	GND	+5V	+12V	VME-Bus J1
Row 2	2b	1b	n.c.	GND	+5V	+12V	VME-Bus J2
Row 3	32c	31c	3c	GND	+5V	+12V	Multibus II
Row 4	32c	1c	13a	GND	+5V	+12V	ECB Bus
Row 5	32c	29a	9a	GND	+5V	+12V	BUS7ISA



*For standard operation of the Com-Server only the 5V supply is needed. The 12V voltage is simply brought through a fuse to Pin 11 on the module slots where it is used to supply future interface modules.*





## **5 Interfaces and displays**

- Ethernet interface
- Serial interfaces and options
- LED displays

## 5.1 Ethernet connection

All Com-Server models incorporate an IEEE 802.3-compatible network interface. Depending on the model, physical connection is made using TP copper cable or fiber optic cable.

### Link-Status

The current link status of all models is indicated by the Error LED on the device front panel: Flashing at a rate of approx. 1 second indicates that there is no connection to the hub or that the connection is faulted.

#### 5.1.1 10/100BaseT on RJ45

Except for model 58651 all Com-Server Highspeed models have a 10/100BaseT network interface on a shielded RJ45 connector. The pin assignments shown below correspond to an MDI interface, so that the connection to the hub or switch is made using a max. 100m long 1:1 shielded patch cable. The OEM model 58432 may also be optionally fitted with an LSA+ insulation displacement terminal.

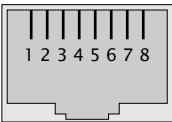

Pin	Direction	Models <i>without</i> PoE	Models <i>with</i> PoE
1	Out	Tx+	Tx+
2	Out	Tx-	Tx-
3	In	Rx+	Rx+
4	In	nc	Vcc positive
5	IN	nc	Vcc positive
6	In	Rx-	Rx-
7	In	nc	Vcc negative
8	In	ncv	Vcc negative

The network connection is galvanically isolated with respect to the supply voltage as well as the serial interface(s) for at least 500V<sub>rms</sub>.

### Power-over-Ethernet

The model 58641 Com-Server 58641 can obtain power as defined in IEEE802.3af/Power-over-Ethernet. Either the data pairs or the unused wire pairs in 10/100BaseT may be used (see also the section *Supply Voltage*).

### Auto Negotiation: 10/100BaseT, Full/Half Duplex

All Com-Servers Highspeed with 10/100BaseT interface are factory set to operate in Auto-Negotiation mode on the network side. The data transmission speed and duplex are automatically negotiated with the connected switch/hub and set accordingly.

In addition to the Auto-Negotiation mode, both the Com-Servers as well as many switches can be configured for fixed transmission parameters with respect to speed and duplex. To prevent communications problems (duplex mismatch), only the following two combinations are permissible:

- *Both* parties (switch and Com-Server) are operated in Auto-Negotiation mode.
- *Both* parties are configured for the same (fixed) transmission speeds and duplex mode.

Use menu sequence *Setup System* → *Link Speed* to switch between Auto-Negotiation and fixed transmission speeds/duplex mode.





*Managable switches often have special protocols (spanning tree, port trunking, ...) as required for example for uplinks to other switches or broad-band connection of servers. These protocols are not generally required for connecting a normal terminal device such as the Com-Server, and they do under some circumstances significantly delay opening of communication after a new start. We recommend deactivating these protocols and functions on the port used for the Com-Server. Please consult here with the responsible network administrator.*

### 5.1.2 100BaseFX with ST

The Com-Server Highspeed 58651 has an optical 100BaseFX network connection on ST connectors with a baud rate of 100MBit/s. Duplex-Multimode fiber optic cables with diameters of 50/125 $\mu$ m or 62.5/125 $\mu$ m may be used. The light used for transmission has a wavelength of 1300nm.

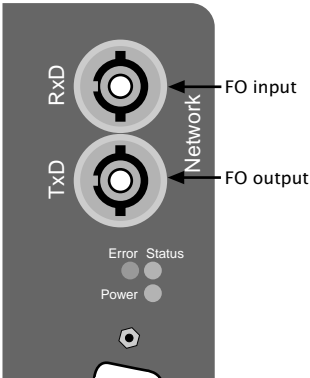
The maximum permissible length of the fiber optic segment between the Com-Server and switch port is 2000m. When using 50/125 $\mu$ m glass fibers an OPB (**O**ptical **P**ower **B**udget) of 7 db is available. When using 62.5/125 $\mu$ m glass fibers the OPB is 10dB.



 *To prevent contamination of the optical contact surfaces, the ST connector should be covered by the appropriate protective caps when storing and transporting the Com-Server.*

### Full/Half Duplex

In contrast to 100BaseTX, 100BaseFX does not support autonegotiating. Therefore the configuration must ensure that the Com-Server and the connected switch port or media converter are configured identically with respect to duplex operation. In the factory default setting the Com-Server works in full-duplex mode. Conversion to half-duplex can be done in the menu branch *Setup System* → *Link Speed*.



*To prevent transmission problems, the Com-Server port and the corresponding side on the switch or media converter must be configured identically with respect to duplex operation.*



*Changing the link speed is activated only after saving and exiting the telnet or WBM session by means of an automatic Com-Server reset. Data from any open network connections is lost. If the newly selected setting is not supported by the port used on the switch or hub, the Com-Server may then not be accessible.*

## 5.2 RS232/422/485 combi-module

Com-Server models 58631, 58641, 58651, 58633, 58031, 58034, 58331, 58334 and 58231 come standard with an RS232/422/485 multi-port whose modes are described below.

The ports on the Com-Server 58633 are also galvanically isolated from each other and with respect to the supply voltage with a dielectric strength of 1kV.

All external signal lines use ESD-immune interface components to provide protection against static discharges of up to 15kV per IEC 801-2, Level 4.

The OEM models 58431 and 58432, which are intended for integration into existing systems, are equipped with a serial TTL interface (= UART interface).

### 5.2.1 Opening the Com-Server

To open the Com-Server, plug the DB9 connector into the serial port. After tightening the two mounting screws, pull on the DB9 plug to remove the circuit board from the housing..

The office versions can be opened by removing the four upper screws on the enclosure sides.

In the case of the compact version 58231, the bump guard on the housing side with the serial port must first be removed. This reveals four screws, which are removed in order to remove the circuit board from the housing.



*Equipping Com-Servers with interface modules other than those already installed is a modification which must be performed only by W&T.*

## 5.2.2 Mode selection

Switching between the modes is accomplished using the internal DIL switches located on the respective interface module. The following table shows an overview of all modes:

Mode	SW1	SW2	SW3	SW4	SW5	SW6	SW7	SW8
RS232 (1)	OFF	OFF	OFF	OFF	OFF	OFF	OFF	ON
RS422, RS485 4-wire bus master	OFF	OFF	OFF	OFF	ON	x	x	OFF
RS485 4-wire automatic control	OFF	ON	OFF	OFF	ON	x	x	OFF
RS485 2-wire automatic control	ON	ON	OFF	OFF	ON	x	x	OFF

(1) Factory default

## 5.2.3 RS232 mode (factory default)

The pin configuration of the RS232 port is identical to that of a PC, which allows you to use standard cables. Be sure that the Com-Server port and that on the serial terminal device are configured for the identical transmission parameters and handshake procedure.

## DIP switch setting

Mode	SW1	SW2	SW3	SW4	SW5	SW6	SW7	SW8
RS232	OFF	OFF	OFF	OFF	OFF	OFF	OFF	ON



*The terminating DIL switches SW6 and SW7 must never be in the ON position when using the module in RS232 mode. This will result in a significant increase in the current draw and may cause the RS232 driver to fail.*

**Pin assignment and function RS232, DB9**

Pin	Direction	Signal	Description	Default Funktion (1)
1	(IN)	NC/DCD	Data carrier detect	1-port models: Not connected 4-port models: Ignored
2	IN	RxD	Receive Data	Data in
3	OUT	TxD	Transmit Data	Data out
4	OUT	DTR	Data Terminal Ready	12V for existing TCP connection to a client or server
5	---	GND	Signal Ground	---
6	IN	DSR	Data Set Ready	ignored
7	OUT	RTS	Ready To Send	Handshake output +12V = ready to receive data - 12V = not ready to receive data
8	IN	CTS	Clear To Send	Send data only at +3...12V
9	(IN)	NC/RI	Ring indicator	1-port models: Not connected 4-port models: Ignored

(1) Applies only to the hardware handshake setting

**Wiring examples**

Com-Server <> PC, 9-pin  
W&T Art. No. 1199x

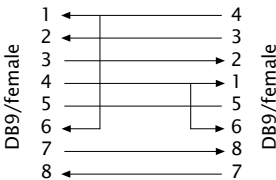

Com-Server <> PC, 25-pin  
W&T Art. No. 1179x

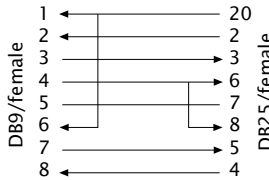

Com-Server -> printer  
W&T Art. No. 1189x

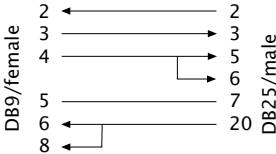

Com-Server <> modem  
W&T Art. No. 1198x

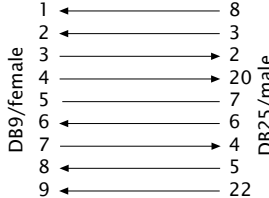



### 5.2.4 RS422/485 mode

As opposed to RS232, an RS422 interface allows transmission distances of up to 1000 meters. The RS485 mode allows you to integrate corresponding 2- or 4-wire bus systems into a TCP/IP network with the help of the Com-Server.



*Especially when using longer cable lengths in industrial environments, potential differences need to be taken into consideration. To prevent any resulting transmission problems or hardware damage, recommended use of the Com-Server Highspeed Isolated 58633, which has three galvanically isolated serial ports. Alternately the galvanic isolation can be achieved by means of an external isolator (e.g. W&T RS422/485-Isolator Model 66201).*

#### DIP switch setting

Mode	SW1	SW2	SW3	SW4	SW5	SW6	SW7	SW8
RS422, RS485 4-wire bus master	OFF	OFF	OFF	OFF	ON	x	x	OFF
RS485 4-wire automatic control	OFF	ON	OFF	OFF	ON	x	x	OFF
RS485 2-wire automatic control	ON	ON	OFF	OFF	ON	x	x	OFF

#### Pin assignment and function RS422/485, DB9

Pin	Direction	Signal	Description	Default function (1)
1	OUT	TxD A/-	Transmit Data A	Data output
2	IN	RxD A/-	Receive Data A	Data input
3	OUT	RTS A/-	Ready To Send A	Handshake output
4	IN	CTS A/-	Clear To Send A	Handshake input
5	---	GND	Signal Ground	---
6	OUT	TxD B/+	Transmit Data B	Data output
7	IN	RxD B/+	Receive Data B	Data input
8	OUT	RTS B/+	Ready To Send B	Handshake output
9	IN	CTS B/+	Clear To Send B	Handshake input

(1) with factory default setting

## Modes

The DIL switches are used to set the following modes:

- **RS422, RS485 4-wire bus master**  
Provides one data and handshake channel each in each direction. The RS422/485 drivers and receivers are always active in this mode.
- **RS485 4-wire with automatic control**  
One data channel is available in each direction. The RS485 driver chip is automatically activated each time data is sent out and then disabled when data is finished sending. The receive channel is always active in this mode.
- **RS485 2-wire bus with automatic control**  
One data channel is available in each direction. The RS485 driver chip is automatically activated each time data is sent out and then disabled when data is finished sending. The receive channel is deactivated when the driver is on, and on when the driver is disabled.

## Handshake for RS485 modes

RS485 bus systems do not use flow control in the traditional sense for data integrity, but rather a logical protocol. The handshake procedure for the Com-Server must therefore be set to NO (see *The serial parameters (Menu: UART Setup)*).

## Terminating

All RS485 modes require a termination network on the bus system which ensures a defined rest state in the high-ohmic phases of bus operation. Connection of the bus system with a termination network can be done in the interface by closing the DIP switches 6 and 7 on the module:

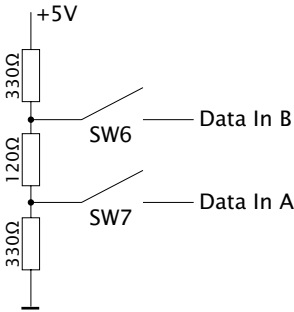

**Wiring examples**

**RS422 connection with hardware handshake**

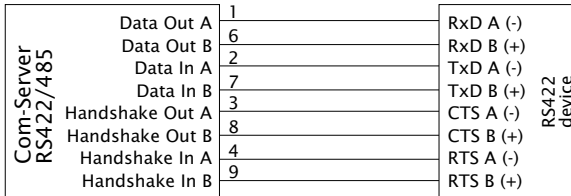

**RS485 connection (4-wire bus master)**

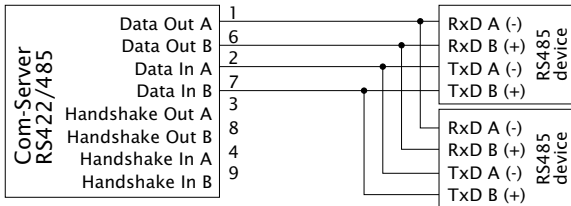

**RS485 connection 2-wire**

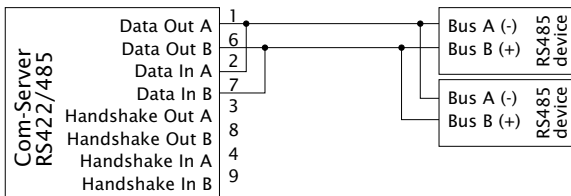

**5.3 Interface for the OEM-Com-Server 58431**

The OEM model 58431 has a UART interface that operates at TTL levels, which is implemented on a 2mm square post header. As an option, interface modules for RS232, RS422/485 or the multi-port can be connected.

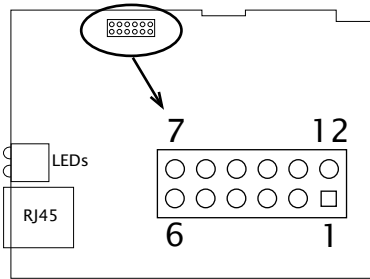

*Wiring assignment for the OEM model 58432 „credit card format“ differ from those described here. For this model please consult the belonging special section*

**Pin assignment and function TTL interface 58431**

Pin	Signal	Function
1	5V	Vcc
2	NC	---
3	RxD	Data in
4	TxD	Data out
5	Reset (1)	Reset in-/output
6	CTS	Input
7	DTR	Output
8	DSR	Input
9	RTS	Output
10	NC	---
11	NC	---
12	GND	Signal ground

*<sup>(1)</sup> The open collector feature of the reset pin allows function as a LOW-active in- and output. A reset triggered for example by the watchdog in the Com Server can be used here for your own*

*purposes. Applying a GND level for at least 100ms (using a button for example) forces a restart of the Com Server.*

**5.4 Option: 20mA interface**

All Com-Servers in the Highspeed series with the exception of model 58633 can be equipped optionally with 20mA interfaces instead of the RS232/422/485 combi-module.

The interface can be used as an active or passive 20mA component. In the active mode the interface supplies the current required by the respective 20mA loop, while in the passive mode the loop current must be supplied by the connected device.

**Pin assignment and function 20mA, DB9**

Pin	Signal	Function
1	Data Out 20mA	Current Out +20mA
2	Data Out +	Output
3	Data Out -	Output
4	Data Out GND	Current Out Ground
5	n.c.	--
6	Data In 20mA	Current In +20mA
7	Data In +	Input
8	Data In -	Input
9	Data In GND	Current In Ground

The operating mode can be selected for both loops seperately. Examples of interface switching into active/ passive mode are shown on the following drawings:

### Com-Server Tx and Rx loop active

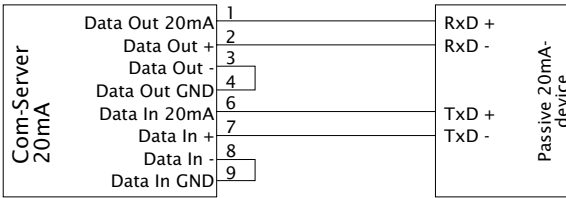

### Com-Server Tx and Rx loop passive

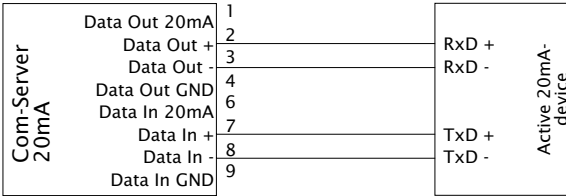

### Com-Server Tx loop active, Rx loop passive

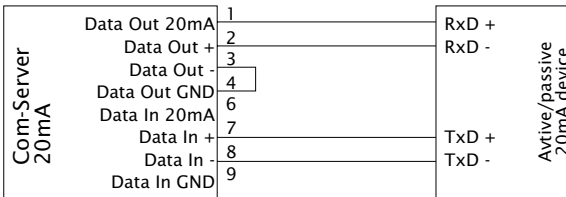

## 5.5 Interfaces for the OEM-Com-Server 58432

The OEM model 58432 in credit card format has in addition to an RS232 interface with TTL levels an onboard RS485 interface. Both interfaces are located on the 10-pin connector X1 with the locking collar. Reconfigure using the solder jumpers on the underside of the board.

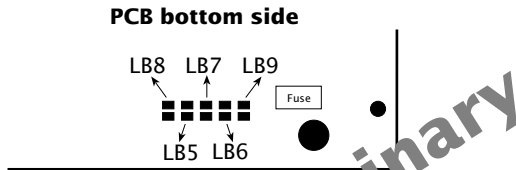
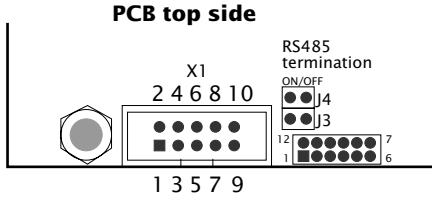

### Pin assignment X1

Pin	Signal	Function RS232 TTL	Function RS485
1	+5V/+24V	Supply	Supply
2	RxD	Input	(RxD)
3	TxD	Output	(TxD)
4	RES/ (1)	In-/Output	(In-/Output)
5	CTS	Input	(Input)
6	DTR	Output	(Output)
7	DSR/A	Input	Bus A/-
8	RTS/B	Output	Bus B/+
9	GND 24V	Supply	Supply
10	GND 5V	Supply	Supply

*(1) The open collector feature of the reset pin allows function as a LOW-active in- and output. A reset triggered for example by the watchdog in the Com Server can be used here for your own purposes. Applying a GND level for at least 100ms (using a button for example) forces a restart of the Com Server.*



**The serial TTL interface**

This interface can be configured as the TTL port of a UART. The solder jumpers must be set as follows:

- LB5, LB6 = in
- LB7, LB8, LB9 = out

**The RS485 interface with automatic control**

The following configuration of solder jumpers establishes a 2-wire RS485 bus connection on pins 7 and 8 of X4.

- LB5, LB6 = out
- LB7, LB8, LB9 = in

The RS485 driver ship is automatically enabled each time data is sent and disabled (high impedance state) again when data output is finished. The RS485 receiving channel is deactivated when the driver is on, but is switched on when the driver is in the high impedance state.

RS485 mode requires that the bus system be terminated with a termination network which ensures a defined idle state in the high impedance phase or bus mode. If the bus system in question does not already have a termination, one can be set using (inserting) jumpers J3 and J4.



*The serial TTL interface and the RS485 bus can be used only in alternation.*

### Basic diagram of the serial interfaces

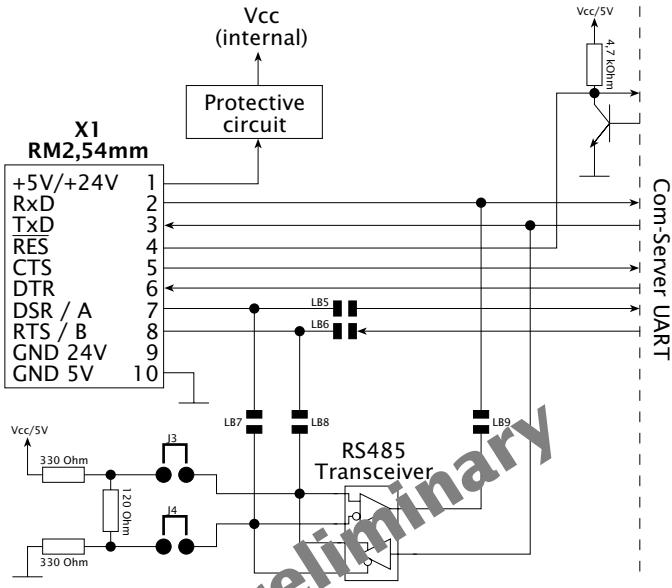

## 5.6 LED displays

### ■ Power LED

Indicates supply voltage present. If the LED is not on, check for correct wiring of the power supply.

### ■ Status LED

Flashes whenever there is activity on the serial port. Periodic flashing indicates that the port has a valid connection to another network station. The status of the serial port can also be read out using the Com-Server's Telnet configuration tool.

### ■ Error LED

The Error LED uses various flashing patterns to indicate error conditions on the device or serial port. The error texts for the previous five serial faults and the associated system time (time between the last restart of the Com-Server and when the error occurred) can also be read out using the Telnet configuration tool.

#### **1 x flashing** = Check network connection

The Com-Server cannot receive a link pulse from a hub. Check the cable or the hub port.

#### **2 x flashing** = Check serial data format

The serial port received at least one character with a parity or framing error (= parity error / framing error), or the data register of the serial receiver ship was written even though the previous character was not read out. Check the correctness of the serial parameters, the handshake procedure and the connection cable.

#### **3 x flashing** = Check serial handshake

The serial connected device is not responding to the handshake stop signal set by the Com-Server and continues to send data. The result can be that the serial ring memory is overwritten and data are lost. Check the handshake

configuration of the device as well as the wiring of the connection cable.

**All LEDs on** = Self-test error

The self-test performed after each start or reset of the Com-Server could not be correctly finished. This error can occur when you have prematurely broken off a software update and the full operating software could not be transferred. The Com-Server is no longer capable of being operated in this condition. Repeat the software update over the network (see „Firmware update of the Com-Server“), and address the Com-Server using its assigned IP address. If this does not eliminate the error or should the error occur irrespective of any prior software update, please return the unit to W&T for service.

## **6 Configuration access to the Com-Server**

After completing the hardware installation and assigning the IP address, the remaining Com-Server configuration takes place over the network. Here either a Telnet client or, after it has been activated, an Internet browser can be used.

- Telnet configuration under Windows
  
- Configuration with the Internet browser

## 6.1 Configuration menu structure

The setup of the Com-Server is treelike regardless of whether the configuration is used for a Telnet client or an Internet browser. An overview of all the levels can be found in the following illustration.

Prior to configuration a valid IP address must have been already assigned to the Com-Server (see “Assigning the IP Address”). Access is then possible from virtually any computer having network access and an installed TCP/IP protocol.

A detailed description of both configuration access types, their conditions as well as the respective navigation within the menu tree can be found in the following section.



*HTTP protocol and its standard port 80 are frequent targets of Web attacks. In order not to impair data throughput of the applications and of the Com-Server, Web Based Management is therefore factory disabled. Ways of activating this as part of the startup process can be found in the section on Web Based Management.*



*If you exit the configuration menu by closing the Telnet connection without first invoking SAVE Setup, the original configuration is retained.*

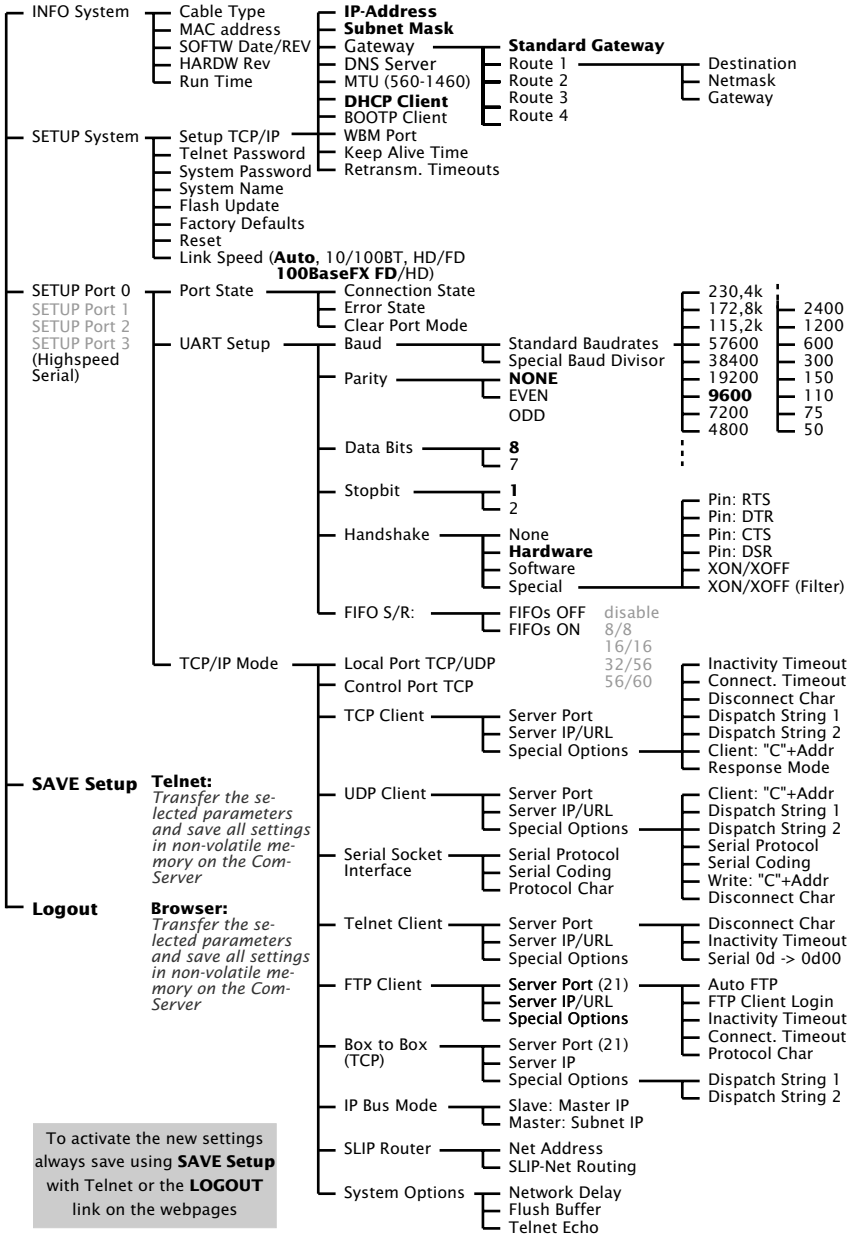

To activate the new settings always save using **SAVE Setup** with Telnet or the **LOGOUT** link on the webpages

## 6.2 Configuration via Telnet

A Telnet client comes standard with nearly all operating systems that support TCP/IP protocol. Under Windows 9x/NT/2000/XP this is normally found in the Windows system directory.

The configuration menu for the Com-Server is reached through TCP port 1111. You must therefore start the connection from within the Telnet client using the corresponding parameters:

```
Telnet [IP address] 1111
```

[address] = IP address of the Com-Server  
1111 = Configuration port of the Com-Server

In Windows 2000 and higher, start using command Start r Run. There enter the command telnet [IP address] 1111.

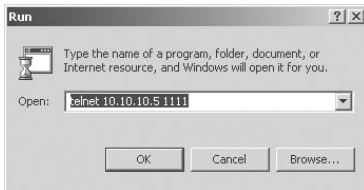

If the connection could be opened and no system password is assigned (= factory default setting), you will see the following menu in your Telnet window. If a system password was configured, this will be asked for in front of the menu.



```
*****
* Com-Server Highspeed *
* COMSERVER-0A1B2C *
*****
1. INFO System
2. SETUP System
3. SETUP Port 0 (High-Speed Serial)
4. SETUP Port 1 (High-Speed Serial)
5. SETUP Port 2 (High-Speed Serial)
6. SETUP Port 3 (High-Speed Serial)
7. SAVE Setup
```

*INFO System*, *SETUP System* and *SAVE Setup* as well as their sub-menus are the same for all Com-Server models and are described in the following section *Basic Configuration of the Com-Server*.

The menu items *SETUP Port x* are dependent of the number of serial ports on the respective Com-Server. For example, all single-port versions will only provide the *SETUP Port 0* menu. The description of these branches can be found in the section *Configuration of the Serial Ports*.

### 6.2.1 Navigation within the Telnet menu

An overview of the entire Com-Server configuration menu is shown on the previous page. On the monitor you will see always just one level of the selected menu. Simply entering the number of the desired menu and pressing the ENTER key takes you to the next level. Entering a q or pressing the ENTER key takes you back to the previous menu level.

The last configured value of a menu item appears in parentheses. If you make changes, the new value will appear at this point the next time the menu is opened. It only becomes effective in the Com-Server itself however if you have saved it using SAVE Setup.

As long as you do not open this menu item, you can move around in the entire menu and change values without actually changing anything.



*If you exit the configuration menu by closing the Telnet connection without first doing a SAVE Setup, the original configuration will be retained.*

### **6.3 Configuration via Browser - Web Based Management**

The Com-Server also allows configuration via HTTP protocol and a standard Internet browser. The menu structure of the WBM (**Web Based Management**) is compatible with the Telnet configuration.

For reasons of security and downward compatibility, WBM is factory disabled.

#### **6.3.1 Activating WBM with the WuTility-Tool**

The Web-Based-Management of the Com-Server can be activated at any time using WuTility as part of assigning the network parameters. Select the Com-Server in the device list and then click on the IP address button. In the first window of the dialog enter the desired values for IP address, subnet mask and gateway and then click on the Continue button. In the following window activate the WBM option and enter the desired TCP port number. As a rule HTTP standard port 80 should be used. If use of port 80 is not possible or desired, then the deviating port number must be explicitly specified in the address line of the browser when opening the Com-Server homepage:

*http://[IP address or Hostname]:[Port number]*

#### **6.3.2 Activating WBM via the serial interface**

When serially assigning the IP number, you can optionally specify the TCP port number under which the WBM should be accessible. To do this, first connect the serial port A on the Com-Server and the COM port on your computer using a null modem cable. Start a terminal program and set the transmission parameters to 9600 baud, 8 data bits, no parity

and no handshake. During a reset of the Com-Server hold the x key down until after approx. 2 sec. the IPno.+<Enter>: prompt appears. Now directly following the IP address enter the extended address string *+w[Portno.]*. *Portno.* represents here the desired TCP port in decimal format. A value of 0 deactivates the WBM.

After finishing your entry by pressing the Return key, the values are stored in the non-volatile memory and you can immediately access the Com-Server and the set WBM port using your Internet browser.



*Additional information about serial configuration possibilities for the Com-Server and navigation within the WBM can be found in the sections Serial Assignment of the IP Address, Subnet Mask and Gateway, and Navigation within the WBM.*

### Example 1:

Here the IP address *172.17.231.99* is assigned to the Com-Server and *+w80* is used to activate the WBM on the HTTP standard port.

```
xxx                -> Com-Server
IP no.+<ENTER>:   <- Com-Server
172.17.231.99+w80 -> Com-Server
172.17.231.99-1  <- Com-Server
```

### Example 2:

In this example the Com-Server gets address *172.17.231.99*, Subnet-Mask *255.255.0.0* and the Gateway *172.17.231.52*. In addition, *-0* is entered to turn off BOOTP/DHCP protocol and *+w8080* to activate WBM on TCP port 8585.

```
xxx                -> Com-Server
IP no.+<ENTER>:   <- Com-Server
172.17.231.99,255.255.0.0,172.17.231.52-0+w8080 -> Com-Server
172.17.231.99,255.255.0.0,172.17.231.52-0+w8080 <- Com-Server
```

### 6.3.3 Activating WBM from the configuration menu

If you want to activate WBM on an already operational Com-Server, you can do this via Telnet configuration. Start a Telnet session on port 1111 of the Com-Server. In the menu branch

*2. SETUP System → 1. Setup TCP/IP → 6. WBM Port*

enter the decimal number of the desired TCP port under which you want to reach the WBM. Then press the Return key until you are back in the main menu and from there open the *SAVE Setup* item. After you have quit the Telnet session, you can now access the Com-Server using an Internet browser.

### 6.3.3 Starting and navigating the WBM

To access the Web pages after activating the WBM, start your Internet browser and enter the IP address of the Com-Server and the configured port number in the address line:

*http://[IP address]:[Portnumber]*

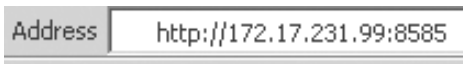

If the HTTP standard port 80 was configured for WBM, you do not need to explicitly indicate the port number in the address line.

You will now be given the start page of the Com-Server with the system password prompt. The factory default setting is for no system password, so that you can get to the configuration menu by simply actuating the login button.

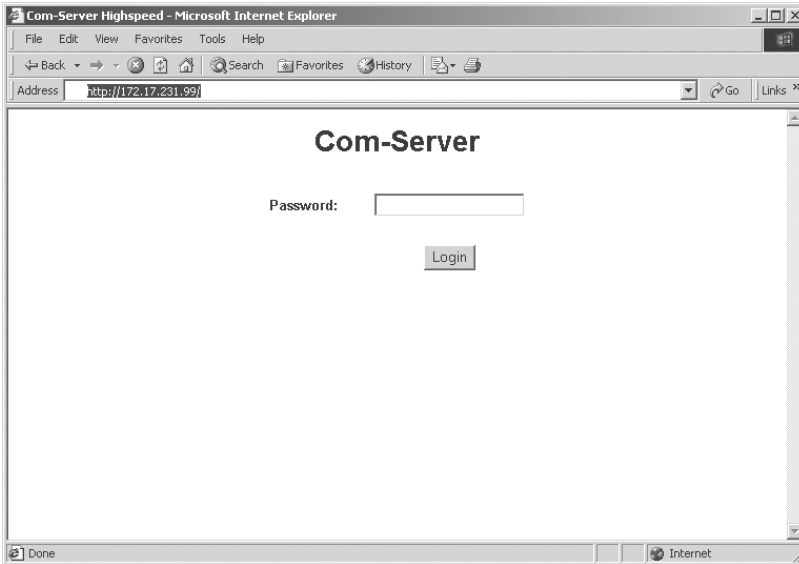

## Navigation

Since the WBM of the Com-Server is session-oriented, you must use *backlinks* and corresponding control buttons to navigate to the individual Web pages. Using the Back function in the browser can lead to problems in accepting the set parameters.

You can make as many settings as desired during a configuration session. Pressing the Send button in the respective pages pastes them to a clipboard. Once all the settings have been made, always exit the configuration session using Link *Logout* and the *Save* button there. Only then are the settings you made copied into the non-volatile memory of the Com-Server and activated.

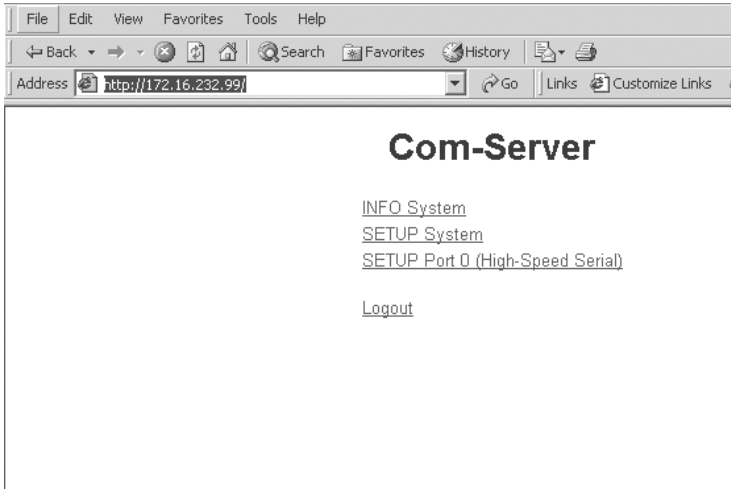

The logout page then offers the following possibilities for ending the configuration session:



Clicking on the *Save* button causes the Com-Server to save all the changes you made in its non-volatile memory and quits the configuration session.



Clicking on the *Abort* button causes the Com-Server to reject all the settings you made and quits the configuration session.



Clicking on the *Restore Defaults* button resets the Com-Server to its original factory setting. All settings including the network parameters IP address, subnet mask and gateway address are lost.

Open port for an update from a non-Windows system



Firmware Update

Clicking on the *Firmware Update* button activates the mode in which the Com-Server expects a firmware update via TFTP protocol (see section *Firmware Update of the Com-Server*). Update mode can be exited only by complete transmission of a valid firmware or by interrupting the supply voltage. When using the *WuTility* tool for the firmware update, this mode is automatically started. In this case a manual start is not necessary.

Reset without saving



Hardware Reset

Pressing the Hardware Reset button restarts the Com-Server, comparable with interrupting the supply voltage. Data from any other opened connections to the Com-Server are lost in this event.



*The functions located on the logout page of the Com-Server can also be found in the Telnet menu branch SETUP System → Setup TCP/IP.*



## **7 The basis configuration of the Com-Server**

Here follows the explanation of all the configuration possibilities related to the Com-Server operating system and which are not directly related to the serial ports. The arrangement and function of the individual parameters within the menu structure are for the most part identical with Telnet and the Internet browser.

- Menu: INFO System
- Menu: SETUP System
- Saving your settings

## 7.1 Saving your settings

When configuring using either Telnet or Web Based Management, all the changes are first saved only temporarily in the Com-Server. To make sure the settings remain intact even after a reset or power failure, each configuration session must be ended with an explicit save procedure.

### ... with Telnet

From the main menu select *SAVE Setup*. Respond with *y* to the *Save Changes ?* prompt. If a correct entry was made, the text *Saving...* will appear on the monitor, and the Com-Server saves all the settings you made in its non-volatile memory. Once the data have been saved, they are activated each time the Com-Server is turned on or reset.

Entering anything other than *y* or simply pressing the ENTER key returns you to the main menu without saving the values.



*Exceptions are the network parameters IP address, subnet mask and gateway, since these are also relevant for the running configuration session. To save and activate these you must enter *q* to quit the Telnet configuration after executing *SAVE Setup*. The Com-Server then autonomously performs a reset and only then begins to work with the new settings.*

### ... with Browser - WBM

Exit the configuration session using the Link *Logout* and click on the *Save* button.

## 7.2 Menu: INFO System

This menu allows you to call up device-specific parameters such as the version number and creation date of the firmware, MAC address of the unit, etc.

↳ **Cable type**

Indicates whether the connection to the hub/switch is using 10BaseT, 100BaseTX or 100BaseFX. The duplex procedure is also indicated (Full- or Half-Duplex).

↳ **MAC address**

Shows the Ethernet address of the Com-Server. This number is factory set and registered. It cannot be changed.

↳ **SOFTW Date/Rev.**

Shows the creation date and version number of the operating software in flash.

↳ **HARDW Rev.**

Shows the version status of the Com-Server hardware.

↳ **Run Time**

Shows the time in hours and minutes since the last Com-Server restart.

## 7.3 Menu: SETUP System

This menu is for configuring all the parameters that pertain to the Com-Server operating system and are independent of the serial interface.

### 7.3.1 Menu: SETUP System – Setup TCP/IP

#### ↪ **IP-Address** (Default = 0.0.0.0)

Enter here the IP address if you want to change it. Please note that this number is not freely selectable, but rather needs to be specified based on the network address of the TCP/IP network. The format corresponds to the normal syntax (e.g. 172.16.231.5).

#### ↪ **Subnet Mask** (Default = 255.0.0.0)

The subnet mask only needs to be entered if the Com-Server will be making connections to another subnet. Enter the subnet mask of the subnet in which the Com-Server is located (e.g. 255.255.255.0). Please note: The IP address determines the network class. From this is derived a default subnet mask (e.g. 255.255.0.0 for a Class B network).

#### ↪ **Gateways** (Default = 0.0.0.0)

In this menu branch the IP address of the standard gateway or router can be configured. If you have not configured fixed routes, the standard gateway is used for all network packets whose destination IP address is not in the local subnet.

#### ↪ **Route 1-4 (Destination, Netmask, Gateway)**

In addition to the standard gateway, up to four fixed routes can be defined. Packets whose destination addresses are in the networks configured here (=destination) are always sent through the gateway assigned to this route. A fixed route is only accepted and stored by the Com-Server if the following check is true:

*Destination AND Netmask == Destination*



*Changes to the system parameters IP-Address, Subnet Mask, Gateway and Route 1-4 cannot be activated right after saving. The Com-Server will use these values only after closing the current Telnet connection using q.*

↪ **DNS Server** (Default: 0.0.0.0)

The entry contains the IP address of the DNS server (Domain Name System). The latter is needed in all client modes of the Com-Server (TCP, UDP, Telnet, FTP client) if the destination system is to be stored in the configuration not as a numerical IP address, but rather in the form of a host name or URL. The name is resolved by the Com-Server is done via UDP using standard port 53 reserved for the DNS.

The Time-To-Live of the IP address resolved for a host name is determined by the Time-To-Live parameter contained in the response from the DNS server. After the name has been successfully resolved this time is displayed in the menu item *SETUP Port 0 → Port State → Connection State*.

↪ **MTU – Maximum Transfer Unit (default: 560)**

This value determines the maximum size of a TCP/IP packet. It refers to the number of bytes (excluding header) that can be sent in a packet. The smaller the MTU, the more network buffer overall is available in the Com-Server. The selectable range begins at 560 and ends at 1460 bytes. The values can be set in increments of 128 bytes (automatic correction).

↪ **DHCP Client** (Default: 1 = ON)

The DHCP protocol is activated with the factory settings (menu entry = 1). The Com-Server attempts to find a DHCP server and get an IP address from it. Entering 0 deactivates DHCP and the Com-Server works statically with the IP address assigned to it. More information on how DHCP works can be found in the section IP Assignment via DHCP Protocol.



*To prevent unintended address assignments or changes, we recommend deactivating the DHCP, BOOTP and RARP protocols if they are not expressly used in the respective network environment.*

↪ **BOOTP Client** (Default: 0 = OFF)

The factory setting is for BOOTP protocol deactivated (menu entry = 0). Entering *1* activates the function and the Com-Server attempts to obtain an IP address from a BOOTP server after each reset. More information on how BOOTP works can be found in the section *IP Assignment via BOOTP Protocol*.



*To prevent unintended address assignments or changes, we recommend deactivating the DHCP, BOOTP and RARP protocols if they are not expressly used in the respective network environment.*

↪ **WBM Port** (Default: 0000)

The decimal value specifies the TCP port under which the Web Based Management (WBM) of the Com-Server is accessible from an Internet browser. The factory setting is 0000, which means WBM is deactivated. If for example you set a value of 80 (= standard HTTP port), you can open the Web configuration from an Internet browser without explicitly specifying the port number. It is sufficient to enter the IP address or the name of the Com-Server stored in the DNS. When using other port numbers, these must be given in the address line of the browser as well separated by a colon (e.g., `http://172.17.231.49:1234`).

↪ **Keep Alive Time (sec)** (Default: 0 = OFF)

If the keep-alive check is activated by entering and saving a value in second ticks, all TCP connections are monitored for network-side data traffic. If there is no network traffic within the set time, the Com-Server generates a keep-alive packet. If the partner does not answer this packet, the connection is reset in the Com-Server. This deletes any data still contained in the serial in- and output buffers.

*Example:* A TCP client has opened a connection to TCP server port 8000 of the Com-Server and the network connection is interrupted. After the set keep-alive time plus 2s for two repetitions has elapsed, the Com-Server closes the connection and is again ready for any other clients.

↪ **Retransmission Timeouts (ms)** (Default: 240)

This timeout determines what time must elapse before network packets are repeated if necessary. In most networks the default setting of 240ms can be used. Only when there are very long latency times between the Com-Server and its respective communications partner would you need to increase this value.

### **7.3.2 Menu: SETUP System – Telnet Password (obsolete)**

Here you may specify an 8-character hexadecimal password (valid characters = 0...9 and a...f) for protecting the configuration menu from unauthorized access. The factory-set password is 00000000. With the password you have unrestricted access to the Com-Server's configuration menu.

You are prompted for a valid password as soon as the Telnet connection for the configuration port is opened. An incorrect entry denies access to the Com-Server's configuration port.



*Resetting or changing any parameters including the password is only possible if you know the old password. Make sure you write it down and keep it in a safe location.*

### 7.3.3 Menu: SETUP System → System Password

The system password, which consists of any 31 (max.) characters, protects against any subsequent configuration and control access to the Com-Server.

- 1111: Telnet configuration menu
- [WBM port]: Web Based management (if enabled)
- 8003: Read the configuration file
- 8004: Write the configuration file
- 8888: Reset Com-Server
- 9084, 9184, 9284, 9384: Reset port status A-D
- 9094, 9194, 9294, 9394: Control port A-D
- 161 (UDP, SNMP)

On Telnet port 1111 and on WBM port the system password is prompted as soon as the connection is opened. For all other associated TCP ports the password must be null-terminated (= [*password*] + 0x00) and sent to the Com-Server no later than 2s after the TCP connection has been established.

Queries from SNMP managers are only responded to by the Com-Server if the community corresponds to the system password.

For additional information on using system passwords in conjunction with the configuration and control ports, see the section „Expanded Services of the Com-Server“.



*The system password is on a higher level than the Telnet password. This means that after assigning a system password, a previously set Telnet password may become invalid, so that the system password must be used for all password prompts.*



### 7.3.4 Menu: SETUP System – System Name

The freely configurable system name consisting of max. 31 characters is used to identify the Com-Server. This name is displayed as an opening message in the client for all Telnet sessions.

The factory default setting for the system name is COMSERVER\_ followed by the last three places of the Ethernet address. For example the factory set system name of a Com-Server with the Ethernet address 00:c0:3d:01:02:03 is *COMSERVER\_010203*. When using DHCP protocol the system name is also used for identification by the DHCP server.

### 7.3.5 Menu: SETUP System – Flash Update

Before you activate the update mode, make sure that you have quit any active network connections. Then confirm with „y“. The update mode is indicated by lighting of the Status LED on the Com-Server.

Activate this mode when you want to perform an update of the Com-Server operating software over the network using the management tool *WuTility* or TFTP (see *Firmware update of the Com-Server*).



*You may quit the update mode only by either completely performing the update or by means of a reset, i.e. turning off the power!*

### 7.3.6 Menu: SETUP System → Factory Defaults

Enter a *y* to reset all the parameters. The configuration is then in its factory preset state. The Com-Server closes the Telnet connection. Then it performs a software reset in order to activate the new configuration.



*Resetting the non-volatile memory causes loss of all the settings which deviate from the default values, including the IP address.*

### 7.3.7 Menu: SETUP System → Reset

Select this menu item to perform a software reset on the Com-Server. First your Telnet connection is properly closed.



*All data from any still open network connections are lost*

### 7.3.8 Menu: SETUP System → Link Speed

#### **Models with 10/100BaseTX interface**

All Com-Server Highspeed models with copper-based network interface are factory set for autonegotiation. Data transmission speed and duplex procedure are automatically negotiated with the connected switch/hub and set correspondingly.

In addition to autonegotiation, the Com-Servers as well as many manageable switches can be configured for fixed transmission parameters with respect to speed and duplex procedure. To

prevent communications problems (duplex mismatch), only the following two combinations are permitted:

- *Both* parties (switch and Com-Server) are operated in Auto-Negotiation mode.
- *Both* parties are configured for the same (fixed) transmission speeds and duplex mode.

### **Models with 100BaseFX interface**

The Com-Server Highspeed 58651 with optical 100BaseFX-Port operates at a fixed baud rate of 100Mbit/s. Only the duplex procedure needs to be set the same as the connected switch or media converter. To prevent transmission problems, unequal settings (= duplex mismatch) must be avoided.



*Changing the link speed is activated only after saving and exiting the telnet or WBM session by means of an automatic Com-Server reset. Data from any open network connections is lost. If the newly selected setting is not supported by the port used on the switch or hub, the Com-Server may then not be accessible.*

## 7.4 Menu ... → TCP/IP Mode → System Options

In this menu branch you can set specific system parameters.

### ↪ **Network Delay [10ms-Ticks]**

**Default: 0000**

This value specifies the minimum delay time of the Com-Server after serial data have arrived. After this time has expired, it packs the data into a network packet and sends them to the respective communications partner. The default setting 0 means the attempt is made to send the data as quickly as possible. The resulting high time transparency does however bring with it the drawback of a higher number of network packets.

If the serial transmission takes place in predictable block sizes, this value can be adjusted to optimize the network load. There is also the advantage that the serial blocks are transmitted within a network packets, so that they arrive at the receiver bundled.

#### **Example:**

You are using serial data blocks of 25 bytes each and transmission parameters of 9600 baud, 8 data bits, no parity and 1 stop bit. Each block thus has a length of approx. 26ms ( $1/9600 * 10 \text{ bits} * 25 \text{ bytes}$ ). If the network delay is set here to a value of 3 (=30ms), each block is sent to the receiver with a network packet.



*The situation described here applies only to a non-overloaded and error-free network. If there are interruptions in the data flow on the network side, any serially accumulated data are also sent in larger network packets.*

↳ **Telnet Echo**  
**Default: active**

When opening a Telnet session, negotiation between the stations takes place on the network side to determine who will generate the echo of the characters sent by the client. Either the client application generates a local echo, or the Telnet server generates a remote echo by immediately returning all received data. The Telnet echo option on the Com-Server is defined as follows:

**Telnet Echo = active**

The Com-Server negotiates a remote echo with the client application, and the local echo is turned off. In this case the device serially connected to the Com-Server must generate the echo.

**Telnet Echo = disabled**

The Com-Server tells the client application when opening the connection that it will not generate an echo, which results there in activation of the local echo. The local echo may have to be manually activated on the Telnet client.

↳ **Flush Buffer**  
**Default: active**

If this switch is *active*, the serial buffer is cleared each time a new connection is opened; any residual data which cannot be transmitted (e.g. handshake stop of the serial terminal device) are thus lost. But if you connect a terminal device to the Com-Server which for example requires a longer handshake stop for program reasons, you can prevent clearing of the buffer by deactivating the switch. In this way multiple connections can be opened one after the other on the network side and the data are accumulated in the buffer until they are sent.



## 8 Configuration of the serial port

### ■ Configuring the serial transmission parameters

In addition to the usual settings for baud rate, data bits, parity and stop bits, the various handshake procedures and available special functions of the individual control signals are explained here.

## 8.1 The serial parameters (Menu: UART Setup)

Like any serial device, the Com-Server port must be set to match the communication parameters of its partner. All the RS232 parameters relevant for operation are configured in the *Setup Port x → UART Setup* menu. In addition to the usual settings for baud rate, data bits, parity and stop bits, here you can also specify the handshake procedure as well as the functions of the individual control signals and the UART-FIFOs.



*The settings only become active after saving with SAVE Setup or pressing the button Save on the Logout page. Please note that saving the parameters deletes all data currently located in the ComServer port buffers.*

### 8.1.1 Baud rate, Data bits, stop bits, parity

The desired transmission parameters can be selected by entering the corresponding designation in the respective branch of the menu tree. Invoking Save Setup in the master menu saves the changes you made in the non-volatile memory of the Com-Server and simultaneously activates them.

#### Freely selectable baud rate (Special Baud Divisor)

In the submenu Special Baud Divisor you can enter any desired divisor for generating the baud rate. This makes it possible to work even with non-standard baud rates. The baud rate and divisor are calculated using the following formulas:

Models 58631, 58431, 58651

$$\text{Divisor} = \frac{11,0592 \cdot 10^6}{16 \cdot \text{Baudrate}} \quad \text{Baudrate} = \frac{11,0592 \cdot 10^6}{16 \cdot \text{Divisor}}$$



Models 58031, 58034, 58633, 58231, 58331, 58334

$$\text{Divisor} = \frac{7,3728 * 10^6}{16 * \text{Baudrate}} \quad \text{Baudrate} = \frac{7,3728 * 10^6}{16 * \text{Divisor}}$$

The currently configured baud rate is displayed when selecting the submenu *SETUP Port x (serial) → UART Setup*.

By allowing any divisor, very high baud rates are possible. Please note in this connection that the upper limit for a bundled data stream is 230.4 kbps.



*The indicated value refers to a handshake-controlled half-duplex transmission with no parity and a non-loaded network.*

### 8.1.2 The handshake modes

(SETUP Port x → UART Setup → Handshake)

This menu provides three standard modes for flow control of the serial port. As opposed to these predefined handshake profiles, you can use the Special submenu to specify the function of each control signal individually. This allows you for example to use hardware-controlled TCP connection control. Details on the control line functions are contained in the description of the submenu.

#### ↪ **Hardware Handshake**

When using hardware handshake, the individual RS232 signals perform their factory-set functions as described in the section „RS232 Interface“. Please note that the meaning of the individual signals may be changed by the respective user software.

Function of the control signal: RTS: Flow Control  
 DTR: Show Connection  
 CTS: Flow Control  
 DSR: NO

**↪ Software Handshake**

The software handshake is implemented using the two ASCII characters (11H)=XON and (13H)=XOFF. In the standard setting Software Handshake these two codes are considered by the Com-Server as control characters and are filtered out from the actual data flow in both directions. This filtering can be turned off individually for each data direction in the Special submenu.

Function of the control signal: RTS: NO (Default HIGH)  
DTR: NO (Default HIGH)  
CTS: NO  
DSR: NO

**↪ NO Handshake**

Turns off any hardware or software flow control for the serial interface. All the data are output to the connected terminal device regardless of the status of the inputs CTS and DSR. Any impending overflow of the serial input buffer is not signalled by the Com-Server. The setting NO Handshake makes sense for any data transmission that uses a serial protocol for data integrity or flow control.

Function of the control signal: RTS: NO (Default HIGH)  
DTR: NO (Default HIGH)  
CTS: NO  
DSR: NO

**↪ Special**

Here it is possible to configure the function of the control lines differently from the three predefined protocols. In addition, the filter function of the „Xon“ and „Xoff“ characters used for the software handshake can be influenced. Toggle between on and off by entering the menu number of the desired function. Settings made here are correspondingly overwritten by selecting one of the three predefined handshake modes.

↳ **Pin: RTS & Pin: DTR**

The following functions can be assigned to the outputs RTS and DTR:

**1. Flow Control** – If this function is turned on, the Com-Server handles the RS232 flow control through the corresponding output. The ready state for serial data is signaled by a HIGH signal (+3...12V). If the memory limit of the input buffer is reached, the line is set to LOW (-3...-12V).

**2. Show Connection** – The output is switched to the serial port depending on an existing TCP connection. HIGH (+3...12V) indicates an existing connection.

**3. NO (Default=HIGH)** – The outputs are not used by the Com-Server and carry a constant HIGH level (+3...12V). A network application can use the control port of the Com-Server (see „Enhanced services of the Com-Server“) to temporarily influence the level.

**4. NO (Default=LOW)** – The outputs are not used by the Com-Server and carry a constant LOW level (-3...-12V). A network application can use the control port of the Com-Server (see „Enhanced services of the Com-Server“) to temporarily influence the level.

↳ **PIN: CTS und PIN: DSR**

The inputs CTS and DSR can be assigned the following functions:

**1. Flow Control** – The serial flow control is performed using the corresponding pin. Serial data are output only if the input was set to HIGH (+3...12V) by the connected terminal device.

**2. OPEN/CLOSE** – Connection This option for TCP connection building and ending can be used to control connection building and ending in all Com-Server client operating modes. If the IP address and the TCP port are stored in the Com-Server, a HIGH level (+3...12V) on the corresponding input establishes a connection. The connection is closed with a LOW level (-3...-12V).

**3. Accept only by HIGH** – Connection establishment of a TCP client is only accepted if a HIGH level (+3...12V) is present on the corresponding input. Likewise the connection is rejected when there is a LOW level.

**4. NO (Manual IN)** – The selected input is ignored by the Com-Server and plays no role either in data transmission or connection control.

↳ **XON/XOFF**

Here the handshake can be configured for XON/XOFF separately for each data direction. "*XON/XOFF Receive*" switches processing of this control character for serial receiving on: After receipt of an XOFF sent by the RS232 terminal device, the Com-Server stops serial data output until it receives an XON. If "*XON/XOFF Send*" is turned on, the Com-Server generates an XOFF when it is no longer able to receive serial data.

↳ **XON/XOFF (Filter)**

If XON/XOFF is turned off for flow control, this option can be used to separately determine for both data directions whether the Com-Server filters these control characters out of the actual data.

**1. Send-Filter (Data direction → serial)**

If this option is turned on and XON or XOFF characters occur in the actual data, the Com-Server filters them out and does not pass them along to the terminal device. Select this mode generally for bi-directional RS232 connections, since otherwise you will have problems with data traffic. If the Send-Filter option is turned off, all the data including the XON and XOFF characters are sent unfiltered on the RS232 interface. This mode only makes sense if the connected terminal device is a graphics printer whose data stream can be expected to contain handshake characters.

## 2. Receive-Filter (Data direction → network)

If this option is turned on, the Com-Server interprets the XON and XOFF characters sent by the serial terminal device as control bytes and does not insert them into the network data stream. This ensures that the recipient in the network only gets actual user data. If Receive-Filter is turned off, the XON and XOFF characters sent by the serial terminal device are transmitted to the network together with the actual user data. This mode requires of the respective recipient in the network that it be able to separate actual data from control data.

The currently selected parameters are shown in the top line of the „UART Setp“ menu. As soon as a parameter is changed, until the parameters are saved this display does not show the configuration with which the Com-Server port is currently working!

Display format:

*[Baud], [Parity], [Data bits], [Stop bits], [Handshake], [FIFO]*

Possible values for the handshake variables are:

		Send-Filter	Receive-Filter
[N]	No handshake	---	---
[H]	Hardware handshake	---	---
[S]	Software handshake XON/XOFF	ON	ON
[Special]	Special setting configuration menu "Handshake-Special"	---	---

### 8.1.3 FIFO Send/Rec

The submenu allows the FIFO memory of the serial receive module to turn on and off. Models 58031, 58034, 58231,

58331, 58334 and 58633 also make it possible to set various trigger thresholds.

Especially when transmitting large quantities of data at high baud rates (above 57.6 Kbaud), it is recommended that you turn on the FIFOs in order to reduce the system load. If for example when working with serial protocols you require as short a delay in data transmission as possible, the FIFOs should be turned off.

## **9 The protocol stack of the Com-Server**

- Services of the Com-Server
- Addressing in the TCP/IP network
- The serial ports as seen from by network

## 9.1 Services of the Com-Server

The actual data are exchanged between the application and the Com-Server port using TCP/IP or UDP/IP. Which protocol is selected and the type of connection (Client or Server) for data transmission depends on the application. The following table shows the various modes of the serial Com-Server port.

### Menu: Setup Port x → TCP/IP Mode

"TCP-Server" Mode	--
"TELNET-Server" Mode	--
"FTP-Server" Mode	--
"TCP-Client" Mode	→ TCP-Client
"UDP-Client" Mode	→ UDP-Client
"TELNET-Client" Mode	→ Telnet-Client
"FTP-Client" Mode	→ FTP-Client
"Box to Box" Mode	→ Box to Box
"IP Bus Mode	→ IP Bus Mode
SLIP-Router	→ SLIP Router
Serial Socket Interface	→ Ser. Socket Interface

In addition to simple transmission of the data, a dedicated TCP port provides functions for monitoring and configuring the serial interface (see *Enhanced services of the Com-Server*).

The Com-Server supports the following protocols:

- ARP, RARP, ICMP (Ping), RIP, DHCP, BOOTP, DNS, SNMP
- IP, TCP (Client / Server), UDP (Client / Server)
- FTP (Client / Server), Telnet (Client / Server), HTTP (WBM)
- SLIP



**9.2 Addressing in the TCP/IP Network**

Addressing in the TCP/IP network is done in two steps. First the network station itself is addressed with the IP address, then the services of this network station are addressed with TCP port numbers. Each IP address must be unique throughout the network, and each port number must be unique on the network station.

Addressing the serial ports is done analogously. The Com-Server is assigned an IP address upon installation (see *Assigning the IP address*). This address is used to access the Com-Server. The individual services are factory addressed using the following port numbers.

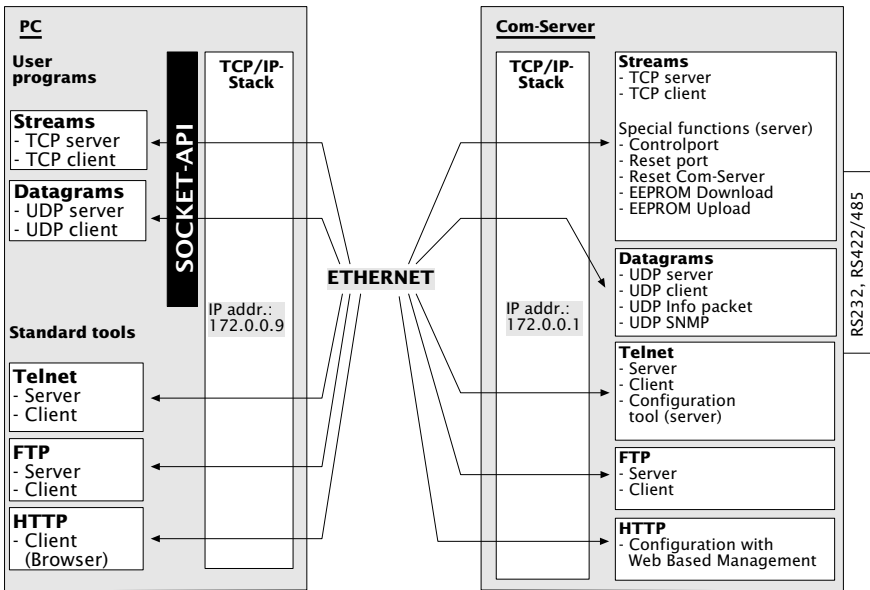

If in a particular case the factory assigned port number cannot be used, you may modify it (see *Configuration of the TCP/IP modes*).

**9.3 The serial ports from the view of the network**

There are several possibilities for transporting serial interface data. The Com-Server port supports the standard protocols FTP and Telnet. It also allows you to transport the data on the socket interface level directly as TCB10.1 P streams or UDP datagrams - in other words, without any additional higher-order protocol. The illustration below shows the protocol layering in the Com-Server:

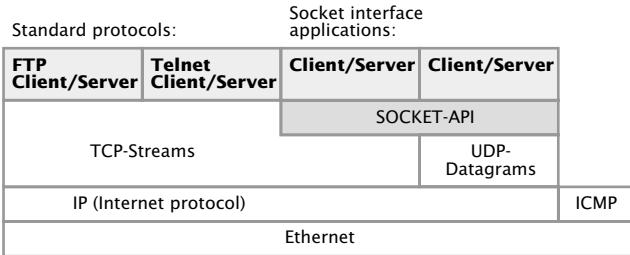

Each mode is explained individually in the following sections. The server mode does not have to be configured separately; it is activated when a client of a TCP/IP station directs a connection request to the server in the Com-Server.

The client processes in the Com-Server need to be set up in the configuration menu of the Com-Server port.

**9.3 1 Data transfer per TCP/IP and UDP/IP sockets**

Using the socket API (under Windows WinSock, under UNIX Berkley Sockets, ...) it is possible to implement a variety of applications in the form of client or server processes on TCP/IP computers. The API offers all the functionality for transporting data over the network. You can customize your application program - that is, the further processing and evaluation of the data - for your particular requirements.

The Com-Server provides both of the protocols possible on the socket level for data transfer: Client/server process with TCP

sockets (streams) or UDP sockets (datagrams). The following comparison shows the essential features of both protocols at a glance.

The Com-Server provides both of the protocols possible on the socket level for data transfer: Client/server process with TCP sockets (streams) or UDP sockets (datagrams). The following comparison shows the essential features of both protocols at a glance.

<b>Feature</b>	<b>UDP</b>	<b>TCP</b>
Data integrity using checksum	Yes	Yes
Connection control using TCP/IP stack (Opening and closing the connection)	No	Yes
Guarantee correct packet sequence using TCP/IP stack	No	Yes
Limit number of active connections on the computer	No with a socket multiple ports can be polled	One socket per connection to a serial port is needed



## **10 Data transfer per TCP/IP sockets**

The most direct way to exchange data with a serial device connected to the Com-Server is via TCP sockets. This is especially useful in cases where communication needs to be integrated into your own programs.

Comparable to traditional telephony, TCP connections always consist of an active, calling side (=Client) and a passive, call-answering side (=Server).

The Com-Server can work both as a TCP server as well as a TCP client. The following section explains the settings needed for both modes.

- The Com-Server as TCP-Server
- Configuration of the Com-Servers as TCP client
- Application example: Client/server connection between Com-Servers

## 10.1 The Com-Server as TCP server

TCP is a connection-based protocol, i.e. during data transmission there is a fixed connection between client and server. TCP possesses all the mechanisms for opening and closing a connection and ensuring errorless data transfer over the network.

The connection is controlled by the user program (client process), which opens (connect()) and closes (close()) the connection. Once a connection is established, data can be exchanged bidirectionally between the two processes. The Com-Server output all the data from the LAN to the serial port and in return reads in all the data from the serial port in order to convey it to your client process.



*When there is no connection, the entry „FREE“ must be visible in the Com-Server port menu SETUP Port 0 → Port State → Connection State. If a connection is active, the entry „In Use Port number <IP address>“ appears there!*

### 10.1.1 Configuration of the local port number

To open a connection to the Com-Server, a client needs an IP address and the TCP port number. Direct access via TCP or UDP to the serial port of the Com-Server is done using the port number stored in the menu branch *Setup Port 0 → TCP/IP Mode → Port Number*. For reasons of downward compatibility with older firmware versions, the following port numbers are pre-configured at the factory:

- Port A = 8000 (all models with only one serial port)
- Port B = 8100
- Port C = 8200
- Port D = 8300

It must be noted that only one TCP client at a time can be connected to the serial port of the Com-Server. If there is already a connection, any attempt from another client is rejected until this first connection has been properly closed or ended by means of a reset.



*This configuration method is intended only for direct socket access per TCP or UDP. Higher-order services like TELNET or FTP are not reachable in this way. If the configurable port number is set to one of the standard values (e.g. 21 for FTP), the associated service is no longer reachable and the data area of the TCP or UDP protocol is passed on transparently to the serial terminal device.*

### 10.1.2 Optional settings

#### Serial transmission parameters

Baud rate, data bits, parity and handshake procedure must conform to the connected serial device. For details see section *Configuration of the Serial Port*.

#### Serial receive buffer

The Com-Server has a serial receiving buffer with 4kB capacity. The *Flush Buffer* option specifies whether received serial data are to be sent to the client or deleted (default setting) after opening a TCP connection. Details can be found in section *Setup Setup Port x → Setup TCP/IP → System Options*

#### Network delay

In its default setting the Com-Server attempts to send the serially arriving data to the network-side application with as little delay as possible. Particularly when working with host serial protocols it may be necessary to send the protocol blocks enclosed in a network packet if possible. The option *Network Delay* in *Setup Setup Port x → Setup TCP/IP → System Options* allows an artificial delay in transmission for this purpose. Details can be found in section *Menu ... Setup TCP/IP → System Options*.

**Keep Alive Time**

If this function is activated, then if there is no data traffic the Com-Server checks during the set time interval to see whether the connected network application can be reached. If there is no reply, for example due to a break in the network infrastructure, the Com-Server resets the connection internally and thus enables a new connection to be opened. Details can be found in section *Menu SETUP System – Setup TCP/IP*.



## 10.2 The Com-Server as TCP-Client

In contrast to the passive TCP server mode, in TCP client mode the Com-Server independently opens connections to a TCP server located in the network. The destination IP address and destination port number needed for this can either be stored in the configuration or sent serially to the Com-Server before the actual user data. A trigger for opening the connection could be serially received characters or status change of a handshake procedure. The connection is closed on a time basis or when a particular serial character is received.

If there is no connection to the TCP server currently active, the port itself can also be a TCP server and accept connections from clients on its default TCP port or on the port configured in the menu branch *Setup Port x → TCP/IP Mode → Port Number*.

After basic startup of the Com-Server and setting the serial transmission parameters in accordance with the connected device, the TCP client mode is configured in the Submenu *Setup Port x → TCP Mode → TCP-Client*.

### 10.2.1 TCP client mode with fixed destination system

The submenu *SETUP Port x → TCP/IP Mode → TCP Client* is where the connection data for the desired TCP server are configured.

#### ↪ **Server Port**

Port number that the application (TCP server process) addresses on the computer.

*Format: decimal*

#### ↪ **Server IP**

IP address or URL of the computer on which your application (TCP server process) is active.

*Format: Dot notation or URL*



A URL can only be assigned in conjunction with a valid DNS server. The name used is not allowed to contain space characters (0x20), nor can the first character be a decimal (0x2E). A server IP or URL is deleted by entering 0.0.0.0. For additional information refer to the section Menu: Setup SYSTEM → Setup TCP/IP → DNS-Server.

### **Opening the TCP connection**

After saving the connection data the Com-Server waits to receive any serial character. This is the trigger for opening the connection and is sent to the TCP server together with the following data.

Alternately the connection can also be triggered via hardware depending on the status of a handshake input on the serial port (CTS or DSR). Details can be found in section *Handshake modes* → *Special* → *Pin: CTS and Pin: DSR*.

### Closing the TCP connection

To close the connection the following methods from the Sub-menu ...*TCP Client* → *Special Options* are available. If connection control is configured using the handshake inputs CTS or DSR, the connection is also closed when this line drops.

#### ↳ **Inactivity Timeout**

**Default: 30**

Here you can specify the value for a timer. When the specified time expires, the Com-Server port closes the connection. The timer is reset if there is an active network connection when data are being exchanged. If no data are set within the specified time, the Com-Server port closes the connection to the TCP server. `InactivityTimeout = 0` deactivates the connection closing after a timeout.

*1 Tick: 1 second*

*Format: decimal*

#### ↳ **Disconnect Char**

**Default: 0**

If the Com-Server receives the character defined here at the serial port, the connection to the TCP server is closed. The character itself is not sent to the TCP server. Default value is 0 (=deactivated).

*Format: decimal*

#### ↳ **Connection Timeout**

**Default: 300**

This value is a connection timeout that is only effective together with an activated *Inactivity Timeout*. After the *Inactivity Timeout* expires, the Com-Server tries to send any still existing, unsent user data for the duration of the Connection Timeout. If it receives no reply from the TCP server within this time, you may assume the connection is „hanging“; the data are then rejected and the connection

reset. To prevent unintended loss of data, make this value sufficiently large. Connection Timeout = 0 deactivates resetting of the connection after a timeout.

*1 Tick: 1 second*

*Format: decimal*

## 10.2.2 TCP client mode with serial addressing

In this mode the address data for the server are not permanently configured, but rather transmitted serially to the Com-Server as an ASCII string in front of the actual data. This makes it possible to open connections to changing TCP servers.

This mode is activated in Submenu *...TCP Client* → *Special Options*:

↪ **Client: "C"+Addr**  
**Default: deactivate**

Activating this switch activates the TCP client mode to alternating TCP servers. The address of the TCP server need not be permanently configured, rather it is send as an ASCII string in front on the user data on the serial port. The string for addressing is not included in the send. There are two possibilities for string format:

1. The parameters *Server Port* and *Server IP/URL* are zero.

```
C[IP address or URL],[port number]<CR>
```

Examples:

```
C172.16.231.101,4800<CR>
```

```
Cwww.comserver.com,9100<CR>
```

2. The parameter *Server Port* contains the Default Port (e.g. 4800), *Server IP/URL* contains the first three bytes of the IP address (e.g.172.16.231.0).

```
C 4.Byte IP address <CR>
```

```
(e.g. "C101<CR>")
```



A URL can only be assigned in conjunction with a valid DNS server. The name used is not allowed to contain space characters (0x20), nor can the first character be a decimal (0x2E). A server IP or URL is deleted by entering 0.0.0.0. For additional information refer to the section Menu: Setup SYSTEM → Setup TCP/IP → DNS-Server.

### Opening the TCP connection

If serial addressing is used, the Com-Server waits to receive a valid address string. Any data arriving prior to receipt of a valid addressing are rejected.

### Closing the TCP connection

As with using fixed destination parameters, the connection can be closed using the options *Inactivity Timeout* and *Disconnect Char*.

## 10.2.3 Optional settings

Using the following optional settings in the submenu *...TCP Client* → *Special Options* various special functions can be activated and deactivated. These apply both for operation with fixed or serial addressing.

### ↪ **Dispatch Str. 1 & Dispatch Str. 2**

**Default: 0000H**

This mode allows compact sending of serial data to the network; the serial data stream is not broken down randomly, rather serial packets can be transferred over the network in their original context as a packet.

In *Dispatch Str. 1* and/or *Dispatch Str. 2* enter in hexadecimal format two characters each to be used for finding the serial data stream. Only when one of the two strings has been found are the data packed into network packets by the serial port. If only one character is to be searched for, *Dispatch Str. 2* must be set to *0000*. If you for example configure *Dispatch Str. 1* to *3100* and *Dispatch Str. 2* to *0000*, only the ASCII character *1* will be searched for.

*Format: 16-bit integer hexadecimal, Host-Order (leading Low-Byte)*

↳ **Response Mode**  
**Default: deactive**

In *Response Mode* the application is informed of the network-side connection status of the Com-Server in the serial terminal device by the output of special characters. This function is only available in TCP client mode.

The following messages are output on the serial port:

**C** (connected)

The connection was successfully opened. There is a TCP connection to the server.

**N** (not connected)

The connection was not successfully opened. There is no response from the TCP server.

**D** (disconnected)

The connection attempt was rejected by the TCP server, or a previously existing connection was normally closed by the TCP server or Com-Server.

**lxxx.xxx.xxx.xxx** (invoked by ...)

A client application on the indicated station successfully opened a TCP connection to the Com-Server (e.g. 1172.20.20.1).

Once you have entered all the parameters in the Com-Server port menu, press the ENTER key several times to return to the main menu and save the entries with *SAVE Setup*. The message *Saving...* appears, then the TCP client mode is activated. The entry *TCP-Client* now appears in the *SETUP Port x → Port State → Connection State menu*. The current status of the connection can be read in this menu at any time.

### 10.2.4 Deactivating TCP client mode

Set the following parameters in the menu branch *SETUP Port x* → *TCP/IP Mode* → *TCP Client* to a value of 0 and save this change:

... → *Server Port*

... → *Special Options* → *Client: "C"+Addr*

Alternately you may use the function *SETUP Port x* → *Port State* → *Clear Port Mode*. The Connection State in the Submenu *SETUP Port x* → *Port State* must then be named *FREE*.

### 10.2.5 Application:

#### Client/Server mode between Com-Server-Ports

There are various ways of connecting two or more Com-Server ports together in this mode. All involved Com-Server ports must be configured for TCP client mode and may then alternately connect to each other when there are data on the serial port. After the data has been send the connection is closed either by the *Inactivity Timeout* or the *Disconnect Character*.

When the clients have changing IP addresses, for example in the case of connections via DSL routers with NAT, alternating operation of the Com-Servers in TCP client mode can also be used as an alternative to Box-to-Box mode. Under *Server IP/URL* the host name of the counterpart is used instead of the numerical IP address. In this case the Com-Server obtains the current IP address first via DNS before the TCP connection is opened. Updating of the DNS system when there is an IP address change must be done by the DSL router itself or by another component with appropriate client service (e.g. DynDNS).



Serial addressing (Parameter *Client: „C“+Addr*) also makes changing connections between multiple Com-Server ports possible. In this case the addressing must be generated by the serial devices.

**Example 1:** A control program polls a measuring device; the measuring device is passive.

**Configuration menu:**  
 – TCP/IP Mode – TCP-Client

**Com-Server A**  
 - Server Port: 8000  
 - Server IP: *IP address Com-Server B*  
 - Client "C"+Addr: deactivate

**Com-Server B**  
 - Server Port: 0000  
 - Server IP: 0.0.0.0  
 - Client "C"+Addr: deactivate

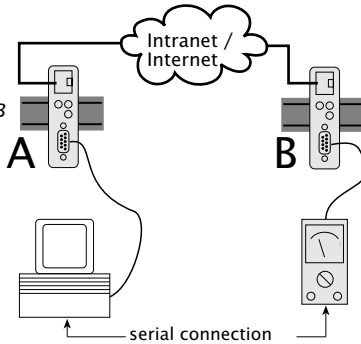

**Example 2:** A control program polls a measuring device; the measuring device can actively send data to the control program.

**Configuration menu:**  
 – TCP/IP Mode – TCP-Client

**Com-Server A**  
 - Server Port: 8000  
 - Server IP: *IP address Com-Server B*  
 - Client "C"+Addr: deactivate

**Com-Server B**  
 - Server Port: 8000  
 - Server IP: *IP address Com-Server A*  
 - Client "C"+Addr: deactivate

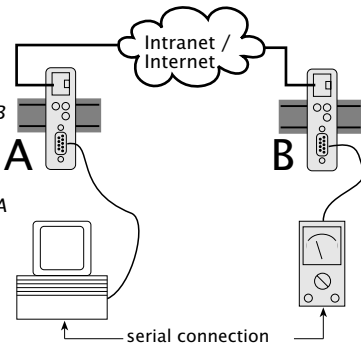

**Example 3:** A control program polls multiple measuring devices; the measuring devices can (e.g. in case of error) independently send data to the control program.

**Configuration menu:**  
 → TCP/IP Mod → TCP-Client

**Com-Server A**  
 - Server Port: 8000  
 - Server IP: *IP address Com-Server B*  
 - Client "C"+Addr: active

**Com-Server B, C, ...**  
 - Server Port: 0000  
 - Server IP: 0.0.0.0  
 - Client "C"+Addr: deactive

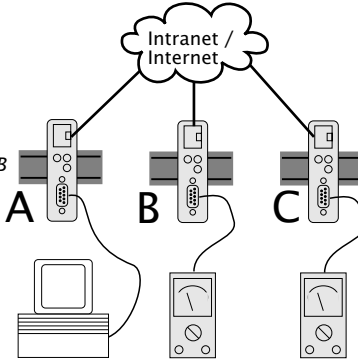

The control program addresses the measuring devices through the serial port in the following format: *C[IP address],[port\_number]<CR>*

Example: *C172.10.230.10,8000*

## **11 Data transfer per UDP**

Instead of TCP, communication with the serially connected devices can also take place via UDP. This method offers several advantages over TCP when the data are secured already within a serial protocol in creating your own software.

### **■ The Com-Server as UDP client**

### 11.1 The Com-Server as UDP peer

UDP is a connection-less and unsecured datagram service. During data transmission there is no fixed connection between the communicating network stations. Datagrams are addressed to the destination in the network without there being any reply referencing the success or failure of the sending. Compared with TCP connections UDP uses the lack of a connection opening to work faster, and timeout situations are eliminated.

UDP does not have any of these mechanisms, but it is sometimes faster, since there is no opening or closing of a connection and there are no timeout situations. Here if a packet is lost, data transmission continues unhindered as long as no higher protocol is there to specify repeats.

Because of the connection-less nature of UDP, the Com-Server port always (whether as client or server) be configured for data exchange using UDP datagrams. There are two ways to specify the network destination for received serial data. One is fixed using the menu points *...UDP Client → Server Port* and *...Server IP/URL*. Alternately you can activate the option *Client:"C"+Addr.*, in which the destination parameters IP address or URL and port number are expected serially before the actual user data.

If the Com-Server is configured as a UDP client, all UDP datagrams addressed to the configured port number are accepted.

### 11.1.1 Setting the local UDP port number

To send a UDP datagram to the Com-Server, the sender needs the IP address of the Com-Server as well as its UDP port number on which the data are received. Access to the serial port on the Com-Server per UDP takes place through the port specified in the menu *Setup Port 0* → *TCP/IP Mode* → *Local Port*. The following port numbers are pre-configured at the factory:

- Port A = 8000 (all models with only one serial port)
- Port B = 8100
- Port C = 8200
- Port D = 8300

If the Com-Server is configured essentially as a UDP client by an entry in the Submenu *...UDP Client* → *Server Port* and *...Server IP/URL*, the data range of all UDP datagrams addressed to the local port number are output on the serial port.



*This configuration method is intended only for direct socket access per TCP or UDP. Higher-order services like TELNET or FTP are not reachable in this way. If the configurable port number is set to one of the standard values (e.g. 21 for FTP), the associated service is no longer reachable and the data area of the TCP or UDP protocol is passed on transparently to the serial terminal device.*

### 11.1.2 UDP clientmode with fixed destination system

In the Submenu *SETUP Port x → TCP/IP Mode → UDP Client* the address data of the desired UDP destination system are configured.

All arriving serial data are sent in UDP datagrams to the configured destination system. Without configuration of additional options there is no effect on the network-side distribution of the data into individual UDP datagrams. To ensure that a serially associated data block is also sent enclosed in a UDP datagram, the latter must have a defined end character or end string (for details see the next section under *Dispatch String*). If there is no defined end character, a time-based structuring using the option Network Delay in the menu branch *Setup Setup Port x → Setup TCP/IP → System Options* can be done. Details can be found in section *The Menu ... Setup TCP/IP → System Options*.

#### ↪ **Server Port**

Port number that the application (TCP server process) addresses on the computer.

*Format: decimal*

#### ↪ **Server IP**

IP address or URL of the computer on which your application (TCP server process) is active.

*Format: Dot notation or URL*



A URL can only be assigned in conjunction with a valid DNS server. The name used is not allowed to contain space characters (0x20), nor can the first character be a decimal (0x2E). A server IP or URL is deleted by entering 0.0.0.0. For additional information refer to the section Menu: Setup SYSTEM → Setup TCP/IP → DNS-Server.

### 11.1.3 UDP client mode with serial addressing

In this node the address data of the destination system are not permanently configured, but rather sent serially to the Com-Server as an ASCII string before the actual user data. This makes it possible to make connections to changing UDP servers.

Serial addressing is activated in the Submenu ...*UDP Client* → *Special Options* using the following options:

↪ **Client: "C"+Addr**  
**Default: deactivate**

Activating this switch activates UDP client mode to alternating UDP peers. The address of the UDP peer need not be permanently configured, rather it is send as an ASCII string in front on the user data on the serial port. The string for addressing is not included in the send.

There are two possibilities for string format:

1. The parameters *Server Port* and *Server IP/URL* are zero.

*C [IP address or URL], [port number] <CR>*

Examples:

*C172.16.231.101,4800<CR>*

*Cwww.comserver.com,9100<CR>*

2. The parameter *Server Port* contains the Default Port (e.g. 4800), *Server IP/URL* contains the first three bytes of the IP address (e.g.172.16.231.0).

*C 4.Byte IP address <CR>*

(e.g. "C101<CR>")



*A URL can only be assigned in conjunction with a valid DNS server. The name used is not allowed to contain space characters (0x20), nor can the first character be a decimal (0x2E). A server IP or URL is deleted by entering 0.0.0.0. For additional information refer to the section Menu: Setup SYSTEM → Setup TCP/IP → DNS-Server.*

↪ **Disconnect Char**  
**Default: 0**

This parameter is only processed if the parameter *Client: "C"+Addr* is activated. If the Com-Server receives the character configured here at its serial port, it deletes the last serially received UDP server address. The character itself is not sent. The preset value is 0.

After you have entered all the parameters in the Com-Server port menu, pressing the ENTER key repeatedly to return to the main menu and save the entries using *SAVE Setup*. The *Saving...* message indicates that the UPD client mode is activated. Now the entry UDP client appears in the *SETUP Port x → Port State → Connection State* menu. The current status of the connection can be read in this menu at any time.



### 11.1.4 Optional settings

The following optional settings in the Submenu ...*UDP Client* → *Special Options* allow you to activate and deactivate various special functions. These apply to fixed as well as serial addressing.

↳ **Dispatch Str. 1 & Dispatch Str. 2**  
**Default: 0000H**

This mode allows compact sending of serial data to the network; the serial data stream is not broken down randomly, rather serial packets can be transferred over the network in their original context as a packet.

In *Dispatch Str. 1* and/or *Dispatch Str. 2* enter in hexadecimal format two characters each to be used for finding the serial data stream. Only when one of the two strings has been found are the data packed into network packets by the serial port. If only one character is to be searched for, *Dispatch Str. 2* must be set to *0000*. If you for example configure *Dispatch Str. 1* to *3100* and *Dispatch Str. 2* to *0000*, only the ASCII character *1* will be searched for.

*Format: 16-bit integer hexadecimal, Host-Order (leading Low-Byte)*

↳ **Special Options** → **Serial Protocol**  
**Default: deactive**

↳ **Special Options** → **Serial Coding**  
**Default: deactive**

The protocol mode activatable using these two menu items has been replaced by the „Serial Socket Interface“ (see section „*Serial Socket Interface*“). For reasons of downward compatibility the functions are still available, but for new applications only the „*Serial Socket Interface*“ should be used.

↪ **Special Options → Write "C"+Addr**  
**Default: deactivate**

Set this switch to active (1) to output the sender address in ,ASCII format before outputting the data for a UDP datagram to the serial port. The string always contains 22 characters.

*C IP address, Port\_number* (e.g. "C172.016.231.101,04800")

### 11.1.5 Deactivating UDP mode

Set the following parameters in the menu branch *SETUP Port x* → *TCP/IP Mode* → *UDP Client* to a value of 0 and save this change:

... → *Server Port*

... → *Special Options* → *Client: "C"+Addr*

Alternately you may use the function *SETUP Port x* → *Port State* → *Clear Port Mode*. The Connection State in the Submenu *SETUP Port x* → *Port State* must then be named *FREE*.

## **12 The Windows COM port redirector**

With the COM Port Redirector available for Windows 9x, NT, 2000, XP and Vista the virtual COM ports are installed in the respective system. These behave in a serial application exactly like normal local ports, but are actually located on Com-Servers located in the network. In this way serially communicating programs can profit from the advantages of network transmission without changing a single line of program code.

■ Download and installation of the COM redirector

## 12.1 Overview

The W&T COM Port Redirector implemented as a Windows core driver provides virtual COM ports which behave like local standard ports with respect to opening applications.

Configuration is registry-based using the COM Port Redirector configuration tool from the Windows start menu. For reasons of downward compatibility with versions < 3.00, there is still a corresponding applet in the control panel. The COM Port Redirector supports all serial W&T COM Servers as well as W&T LAN modems. In addition, the Soft Link function (license required) allows serial applications to be coupled for any computer.

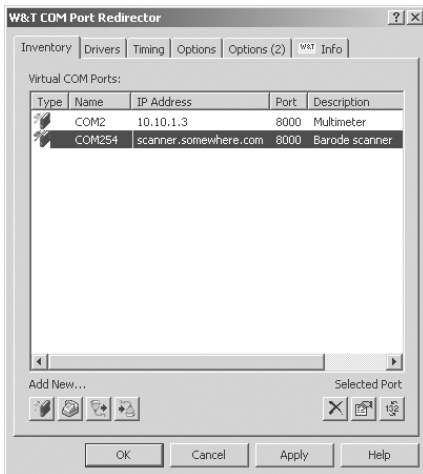

 The following sections describe a quick start-up which is sufficient for many applications. More detailed information for all configuration options for the W&T Com Port Redirector can be found in the online help.

## 12.2 Download & installation of the W&T COM redirector

The latest version of the COM Port Redirector as well as additional tools, application descriptions and FAQs can always be downloaded from our Web site.

<http://www.wut.de>

The simplest way to navigate from there is by using the menu tree on the left side of the page. Follow the

*Downloads → Com-Servers*

path to get to the website containing a direct link to the COM Port Redirector.

Use of the COM Port Redirector in connection with Com-Servers is free and not subject to any licensing requirements.

### 12.2.1 Installation of the W&T COM port redirector

System requirements for installing the W&T Com Port Redirector:

- Operating system Windows NT, 2000, XP, Vista
- Login as administrator or with administrator rights



*Installation of the W&T Com Port Redirector is done as an update to any already existing older versions. All settings and connection parameters are saved and remain available unchanged. To prevent restarting of the computer when your are finished, quit all applications and services which are actively accessing COM ports before performing the update.*



*Administrator rights for the system are needed only for installing and configuring the COM Port Redirector. Normal access to the virtual COM Ports is possible even with limited rights.*

After downloading and unpacking the archive, start the MSI file to start installation. In addition to setting up the core driver, links to the configuration tool in the Windows Start menu under *W&T COM Port Redirector* as well as the control panel are created.



### **12.2.2 Uninstalling the W&T COM Port Redirector**

The W&T COM Port Redirector is uninstalled using Windows software administration. Start the Software applet in the control panel and there select the entry *W&T COM Port Redirector*. Clicking on the *Remove* button removes the COM Port Redirector from the system.

## 12.3 Set up virtual COM ports

To set up a new virtual COM port, start the COM Port Redirector configuration applet in the control panel and click on the Com-Server button. A dialog box opens which you fill in and then click on OK. All settings can also be corrected later by editing the corresponding entry in the port list. Once all your entries have been made, click on OK. It is not normally necessary to restart Windows in order to use the new COM port.

### TCP-Port

The entry field *TCP Port* in the dialog box contains the TCP port used for transporting the serial user data. To communicate with a Com-Server configured with the factory default settings, you must use the following value:

- ↪ Com-Server Port A: 8000
- ↪ Com-Server Port B: 8100
- ↪ Com-Server Port C: 8200
- ↪ Com-Server Port D: 8300

In addition to the indicated TCP port for user data transport, the COM Port Redirector uses an additional TCP connection for exchanging configuration and status information. The port number used for this is always calculated from the formula *data port* + 1094 (e.g. 8000 + 1094 = 9094). If - for example when a firewall is present - you need to deviate from the prescribed TCP port, the TCP ports entered in the COM Port Redirector must also be set correspondingly in the following menu branches of the Com-Server:

Data port:

*SETUP Port x* → *TCP/IP Mode* → *Local Port*

Control port:

*SETUP Port x* → *TCP/IP Mode* → *Controlport*

### 12.3.1 Com-Server settings

Starting with the factory default setting of the Com-Server only the 3 network-specific parameters *IP Address*, *Subnet Mask* and *Gateway Address* need to be configured for operating with the COM Port Redirector. It is not necessary to set the serial transmission parameters such as baud rate. These are determined by the serial application and sent by the COM Port Redirector to the Com-Server over the network.

Only if a TCP port which differs from the factory default setting was entered in the COM Port Redirector do you need to configure the corresponding values in the following menu branches of the Com-Server as well:

Data port:

*SETUP Port x* → *TCP/IP Mode* → *Local Port*

Control port:

*SETUP Port x* → *TCP/IP Mode* → *Controlport*



## **13 Box-to-Box mode**

In „Box to Box“ mode any two Com-Server serial ports can be logically linked to each other over the network. The two connected serial terminal devices are in constant online contact in this mode.

- Typical applications
  
- Configuration of Box-to-Box connections

### 13.1 Box-to-Box application

This mode is based on a permanent TCP connection between two serial ports on Com-Servers distributed in the network. One of these ports acts as the master, the other as slave, though is essentially makes no difference which device is acting as master or slave. The master port functions as a TCP client and is thereby responsible for opening (after configuration or reset) and closing (after deactivating *Box-to-Box* mode).

On the network side the Com-Servers in a Box-to-Box connection only exchange data when there are serial user data present. There is no acknowledgement traffic beyond the TCP protocol..

As a consequence of the permanent connection, both Com-Servers in a Box-to-Box connection must have fixed IP addresses. In applications with changing IP addresses as found for example with many standard DSL connections, alternating TCP client mode may be used, since this allows specifying the destination in the form of a URL. The prerequisite is that the alternating IP address be updated using an appropriate service (e.g. DynDNS) within the DNS system. For details on this mode refer to the section *The Com-Server as TCP Client → Application examples*.

#### Typical Applications

- Replacing complex serial star topology wiring, such as in small business systems
- Serial connections over longer distances. A pair of Com-Servers replaces two line drivers and offers in addition error correction using the Ethernet transmission procedure.
- Serial remote connection using already existing Ethernet-Internetwork connections (routers, bridges, etc.).
- Implementing serial connections with frequently changing operating sites without additional cable expenditure - simply plug into the Ethernet cable!

### 13.1.1 Configuring Box-to-Box mode



*Only the Master port is configured for „Box to Box“ mode; The Slave IP address and Slave port number are set only on the Master port! Settings in the Special Options submenu and parameterizing of the serial port can and must be done on both ports (see examples at the end of this section).*

The following settings must be made in the Submenu *SETUP Port x* → *TCP/IP Mode* → *Box to Box* of the Com-Server which is specified as the master:

↳ **Slave Port** (set only for master port)

Port of the serial Com-Server Slave port. The following port numbers are pre-configured at the factory:

- Port A = 8000 (all models with only one serial port)
- Port B = 8100
- Port C = 8200
- Port D = 8300

The serial port of a Com-Server can easily be „connected“ with one of the up to four serial ports of another Com-Server.

↳ **Slave IP-Address** (set only for master port)

IP address of the Com-Server in which the Slave port is located.

Once you have entered all the parameters in the Com-Server port menu, press the ENTER key several times to return to the main menu and save the entries with *SAVE Setup*. The message *Saving...* appears, then „Box to Box“ mode is activated. The entry *Box to Box Master* now appears in the *SETUP Port x* → *Port State* → *Connection State* menu. The connection status can be read at any time in this menu both for the Master and for the Slave port.

### 13.1.2 Optional settings

#### ↪ **Sepecial Options → Dispatch Str. 1 & Dispatch Str. 2** **Default: 0000H**

This mode allows compact sending of serial data to the network; the serial data stream is not broken down randomly, rather serial packets can be transferred over the network in their original context as a packet.

In *Dispatch Str. 1* and/or *Dispatch Str. 2* enter in hexadecimal format two characters each to be used for finding the serial data stream. Only when one of the two strings has been found are the data packed into network packets by the serial port. If only one character is to be searched for, *Dispatch Str. 2* must be set to *0000*. If you for example configure *Dispatch Str. 1* to *3100* and *Dispatch Str. 2* to *0000*, only the ASCII character *1* will be searched for.

*Format: 16-bit integer hexadecimal, Host-Order (leading Low-Byte)*

### 13.1.3 Deactivating Box-to-Box mode

Just as in the case of configuration, Box-to Box mode only needs to be deactivated at the Master port in order to properly close the TCP connection. The Slave port and the Master port must both be located on the Ethernet.

Set the entry *Slave Port* in the *SETUP Port x → TCP/IP Mode → Box to Box* menu to zero („0“), or use the menu *SETUP Port x → Port State → Clear Port Mode*.

If for any reason the Slave port is not released, you may also use the menu *SETUP Port x → Port State → Clear Port Mode* in the *Slave port* menu.

### 13.1.4 Sample configuration for Box-to-Box mode

#### **Box-to-Box Master**

IP address: 172.16.231.8  
Port number of Port A: 8000

- SETUP Port 0
  - ↳ TCP/IP Mode
    - ↳ Box to Box
      - ↳ Slave Port **8000**
      - ↳ Slave IP-Address **172.016.231.005**
      - ↳ Special Options
        - ↳ Dispatch Str.1 **0D0A**
        - ↳ Dispatch Str.2 **0000**

#### **Box-to-Box Slave**

IP address: 172.16.231.5  
Port number of Port A: 8000

- SETUP Port 0
  - ↳ TCP/IP Mode
    - ↳ Box to Box
      - ↳ Slave Port **0000**
      - ↳ Slave IP-Address **000.000.000.000**
      - ↳ Special Options
        - ↳ Dispatch Str.1 **3132**
        - ↳ Dispatch Str.2 **0D0A**

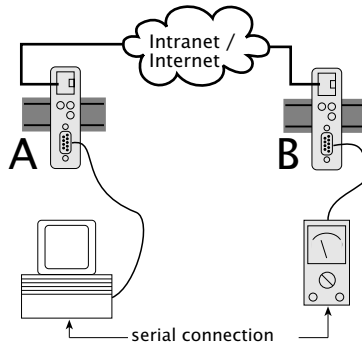

The Slave address is only configured on the Master Com-Server. The Dispatch Strings may be set on both ports however. In addition, the serial transmission parameters (baud rate, data bits, etc.) in *both* Com-Servers must conform to those of the connected devices.



## **14 Data transfer per FTP**

The FTP, which is based on TCP, is a standard protocol for file transmission. In the mode as FTP server an FTP client can send files to the Com-Server whose contents are sent to the serially connected device. In the other direction, serial data arriving at the Com-Server from the FTP client can be written to a file.

If the Com-Server is configured as an FTP client, automatic connection to an FTP server is opened triggered by serial data reception. In this mode serial data can be automatically written to files and files fetched for serial output by the FTP server.

- The Com-Server as FTP server
- Configuration of the Com-Server as FTP client
- Application examples of FTP client modus

## 14.1 The Com-Server as FTP server

This mode should be used if the data to be sent exist as files and the action will always be pre-settings on the Com-Server are necessary for this mode. You can access the unit just like any other station in the network under its name or IP address.

The port numbers under which the Com-Server makes its FTP service available are fixed and cannot be configured:

Default port numbers:

- Port A = 21 or 7000
- Port B = 7100
- Port C = 7200
- Port D = 7300

The IP address or the host name of the Com-Server as well as the above mentioned port numbers must be used as destination parameters for opening the connection in the respective FTP client. Using the example for the standard destination-oriented FTP client included with Windows the invocation is as follows

```
ftp [IP address] or ftp [Host name]
```

After entering the ftp command you can acknowledge the prompt for a login name with ENTER.

The following commands are available:

↪ PUT *[local file] [remote file]*

Sends the file *local file* to the RS232. Enter any desired character for *[remote file]*, since no remote file exists.

↪ GET *[remote file] [local file]*

Gets characters from the RS232 in local file. Again enter any desired letter, or encode a timeout criterion for the data transfer. Enter a number no longer than 3 digits (one tick corresponds to one second). If *[remote file]* does not contain a value in this range, the connection will be broken off 30 seconds after the last retrieved character.



**Example:** *GET 5 /user/cs\_in* (breaks the connection off after 5 seconds of no data traffic) For the exact syntax of your function invocations, please consult the user's manual for your FTP software.

↳ ASCII

Send in ASCII mode

↳ IMAGE

Send in binary mode

↳ QUIT

Ends the FTP session



*The entry FREE must be located in the SETUP Port 0 Port State → Connection State menu before a connection can be opened*

## 14.2 The Com-Server as FTP client

This mode enables access to files on any TCP/IP computer having an activated FTP server. The action must always be initiated by the serial terminal device.

The address of the FTP server (Port number and IP address) must in any case be configured in the Com-Server. For the sequence of the FTP protocol (Login, file command, ...) there are two possibilities: The automatic FTP client and the FTP client with serial protocol.

### 14.2.1 Configuring the destination address and port no.

Regardless of whether the FTP protocol is handled automatically or with the help of the serial protocol string, the address data for the respective FTP server must be configured in the submenu *Setup Port x* → *TCP Mode* → *TCP-Client*.

#### ↪ **Server Port**

Port number that the FTP server addresses (Standard-FTP-Port: 21)

*Format: decimal*

#### ↪ **Server IP/URL**

IP address or URL of the TCP/IP computer on which the FTP-Server is active.

*Format: Dot notation or URL*



A URL can only be assigned in conjunction with a valid DNS server. The name used is not allowed to contain space characters (0x20), nor can the first character be a decimal (0x2E). A server IP or URL is deleted by entering 0.0.0.0. For additional information refer to the section Menu: Setup SYSTEM → Setup TCP/IP → DNS-Server.

Once you have entered all the parameters in the Com-Server port menu, press the ENTER key several times to return to the main menu and save the entries with *SAVE Setup*. The message *Saving...* appears, then the FDP client mode is activated. The entry *FTP-Client* now appears in the *SETUP Port x → Port State → Connection State* menu. The current status of the connection can be read in this menu at any time.

**14.2.2 The automatic FTP client mode**

This mode is recommended whenever you need to execute the same command over and over again. The FTP commands are configured in the Com-Server. The latter opens a connection to the FTP server when it receives data at the serial port. It sends the login and runs the configured file command (getting serial data and saving as a file or reading a file from the FTP server and outputting at the serial port). Then the connection is closed. In the menu branch *SETUP Port x* → *TCP/IP Mode* → *FTP Client* → *Special Options* the following parameters must be configured.

↪ **Auto FTP**

Set this switch to *active* to activate the automatic FTP client.

↪ **FTP Client Login**

Enter the FTP commands one after the other:

↪ Login

Login name for the FTP server

↪ Password:

Login password for the FTP server

↪ [TYPE A/TYP E I]

Transmission mode (ASCII/binary)

↪ [STOR/APPE/RETR/LIST] [*dir/file*]

File command (see command list at end of sect.)

		Open connection	Close connection
LIST RETR	Directory File	The connection is opened when any character is received at the serial port. This character is not sent.	The connection is closed when the FTP server has sent all data
APPE STOR	File File	The connection is opened when the first character to be sent is received at the serial port.	The connection is closed when no serial data have arrived during the time period specified under <i>Inactivity Timeout</i> or when the <i>Protocol Char</i> was received.

If a command sequence was already configured, it is shown when opening the menu.



*A maximum of 80 characters are available for all commands! Commands are case sensitive.*

Once you have entered all the parameters in the Com-Server port menu, press the ENTER key several times to return to the main menu and save the entries with *SAVE Setup*. The message *Saving...* appears, then the FDP client mode is activated. The entry *FTP-Client* now appears in the *SETUP Port x → Port State → Connection State* menu. The current status of the connection can be read in this menu at any time.

### **Opening the FTP connection**

After saving the connection data, the Com-Server waits to receive any serial character. This is the trigger for opening the connection. After successful login on the FTP server using the configured password, the stored command is executed. In the case of *STOR* or *APPE* the connection-triggering character is sent and written to the file.

### **Closing the FTP connection**

The following methods for closing the FTP connection are available in the submenu *...FTP Client → Special Options*.

#### **↪ Inactivity Timeout**

##### **Default: 30**

Configure a timeout for the FTP commands *APPE(nd)* and *STOR* for breaking off the connection. If no serial data are received during this time, the FTP client closes the connection to the FTP server. *Inactivity timeout = 0* means *infinite*. In this case the parameter *Protocol Char* must be configured.

*1 Tick: 1 second*

*Format: decimal*

↳ **Protocol Char**  
**Default: 0**

With an ASCII-data transfer (*TYPE A*) the receipt of the protocol character in the data stream causes a shut down of the connection. With a *Protocol Char* value 0 the Com-Server searches for nullbytes (0x00) in the data stream.

If the transmission takes place with *TYPE I* (binary), the occurrence of the *protocol character* in the data stream will be ignored. In this case the parameter *Inactivity Timeout* must be configured to close the connection.

*Format: decimal*

↳ **Connection Timeout**  
**Default: 300**

This value is a connection timeout that is only effective together with an activated *Inactivity Timeout*. After the *Inactivity Timeout* expires, the Com-Server tries to send any still existing, unsent user data for the duration of the *Connection Timeout*. If it receives no reply from the TCP server within this time, you may assume the connection is „hanging“; the data are then rejected and the connection reset. To prevent unintended loss of data, make this value sufficiently large. Connection Timeout = 0 deactivates resetting of the connection after timeout.

*1 Tick: 1 second*  
*Format: decimal*

### 14.2.3 FTP client with serial protocol

This mode is recommended where constantly changing commands with different files need to be executed and where terminal entry is possible or there is a programmable serial device.

FTP commands for the FTP client

TYPE	A or I	Activation of ASCII or binary mode
STOR	File	Saves all serially received data in <i>File</i>
APPE	File	Saves all serially received data to the file end of <i>File</i>
RETR	File	Outputs <i>File</i> to the serial port
DELE	File	Deletes <i>File</i>
LIST	Directory	Outputs the directory contents on the serial port
RESET		Generates a software reset of the Com-Server. This command may only be used if there is no active connection to the FTP server.

The sequence of the FTP commands is given to the Com-Server port on the serial interface. The Com-Server gets the command sequence, opens the connection to the FTP server and gives an OK to start data transmission. In the menu *SETUP Port x* → *TCP/IP Mode* → *FTP Client* → *Special Options* configure the following parameters:

#### ↳ **Auto FTP**

Set this switch to *deactive* to activate the serial protocol of the FTP-Client

#### ↳ **Protocol Char**

**Default: 0**

Choose and enter here a character with which the sequence of FTP commands will be separated from the user data stream. The pre-adjustment is 0. With an ASCII-data transfer (*TYPE A*) the receipt of the protocol character in the data stream causes a shut down of the connection. If the transmission takes place with *TYPE I* (binary), the

occurrence of the protocol character in the data stream will be ignored. The only possibility for a disconnection in this case is by way of an inactivity timeout.

*Format: decimal*

Once you have entered all the parameters in the Com-Server port menu, press the ENTER key several times to return to the main menu and save the entries with *SAVE Setup*. The message *Saving...* appears, then the FDP client mode is activated. The entry *FTP-Client* now appears in the *SETUP Port x → Port State → Connection State* menu. The current status of the connection can be read in this menu at any time.

### Opening the FTP connection

After saving the configuration data the Com-Server waits to receive a valid serial login string in the following format.

In serial generation of the login string, the individual commands are separated from each other by a linefeed (0x0a). The character configured under Protocol Char must be sent as a terminator. When entering via keyboard, the character can be generated by pressing CTRL J. This results in the 3 following formats for the login string:

```
login<lf>
password<lf>
TYPE I or TYPE A<lf>
STOR, RETR, APPE oder LIST dir/remote file<lf>
<Protocol Char>
```

```
login<lf>
password<lf>
DELE dir/remote file<lf>
<Protocol Char>
```

```
RESET<lf>
<Protocol Char>
```



*Please note capitalization of the commands. A maximum of 128 characters are available for the complete login string!*



### Closing the FTP connection

As with fixed login parameters, the connection can be closed using the options *Inactivity Timeout* and *Disconnect Char*. Details can be found in section *Automatic FTP-Client mode*.

#### 14.2.4 Deactivating FTP client mode

Set the following parameters in the menu branch *SETUP Port x* → *TCP/IP Mode* → *FTP Client* to a value of 0 and save this change:

... → *Server Port*  
... → *Server IP/URL*

Alternately you may use the function *SETUP Port x* → *Port State* → *Clear Port Mode*. The Connection State in the Submenu *SETUP Port x* → *Port State* must then be named *FREE*.

#### 14.2.5 Application examples

##### Example 1:

Opening and closing the connection

1. Send the command string to the serial port. If the complete string was received, the Com-Server begins to open the connection and process the commands.
2. If the functions can be executed one after the other, you get the string *OK + Protocol Char*.
3. Then the actual user data are sent, depending on the command either from the serial port to the network or the reverse.
4. In case of error the FTP server sends the error code + *Protocol Char + Protocol Char*.
5. The connection is automatically closed in either case, and you receive the end code + *Protocol Char* from the FTP server.

**Example 2:**

User egon having the password happy wants to output the file /etc/hosts in ASCII format. The value „003“ (Ctrl C) is entered as Protocol Char. The protocol would look as follows:

Com-Server	Serial device
egon<lf>happy<lf>TYPE A<lf>RETR /etc/hosts<lf><Ctrl C>	←
→	
OK<Ctrl C>	
→	
[content of file]<Ctrl C>	
→	
221 Goodbye<Ctrl C>	

**Example 3:**

User egon having the password happy would like to insert binary data to the end of the file /usr/egon/config. The value „003“ (Ctrl C) is entered as Protocol Char. The protocol would look as follows:

Com-Server	Serial device
egon<lf>happy<lf>TYPE I<lf>APPE /usr/egon/config<lf><Ctrl C>	←
→	
OK<Ctrl C>	
→	
[binary Data]	←
→	
221 Goodbye<Ctrl C>	

**Example 4:**

User egon having the password happy would like to view the file /usr/privat and transfer the data in ASCII. The file does not exist however. The protocol would look as follows:

Com-Server	Serial device
egon<lf>happy<lf>TYPE A<lf>RETR /usr/privat<lf><Ctrl C>	←
→	
550 /usr/privat: No such file or directory<Ctrl C><Ctrl C>	
→	
221 Goodbye<Ctrl C>	

## **15 Data transfer per Telnet**

Telnet is a terminal emulation protocol. Data transmission is character-oriented. Telnet allows bi-directional character exchange between the TCP/IP computer and the serial terminal device connected to the Com-Server.

- Com-Server as Telnet server
  
- Configuring the Com-Server as Telnet client

## 15.1 Com-Server as Telnet server

No pre-settings are necessary on the Com-Server. You can access the device just like any other station in the network under its name or IP address.

The port numbers under which the Com-Server makes its FTP service available are fixed and cannot be configured:

Default port numbers:

- Port A = 23 or 6000
- Port B = 6100
- Port C = 6200
- Port D = 6300

Telnet invocation:

```
telnet [IP address] or telnet [Host name]
```

If the connection can be opened, a message from the TELNET server appears on the screen. From here on data can be read in or output a character at a time from the keyboard.

All data received from the serial port are output on the screen and - if desired - recorded in a protocol file. All keyboard entries are output as data a character at a time on the serial port.

The echo behavior of the Com-Server can be configured in the menu branch *SETUP Port x → TCP/IP Mode → System Options*. By default the Com-Server signals the respective Telnet client that the serially connected device is generating the echo of the received characters. This causes the client to not generate its own local echo. If no serial device is connected or if one does not generate an echo, characters entered on the client are not shown there. For additional information, refer to the section *Menu ... → TCP/IP Mode → System Options*.

## 15.2 The Com-Server as Telnet client

This mode is the simplest way to implement terminal emulation on a serial terminal device and thereby to effect direct communication with the TCP/IP station on which the Telnet server is active. The Com-Server opens the connection as soon as the serial port has received a character.

After base startup of the Com-Server and setting the serial parameters to match the connected device, configuration of the TCP client mode is done in the Submenu *Setup Port x* → *TCP Mode* → *TCP-Client*.

### ↪ **Server Port**

Port number that the Telnet server addresses (Standard-Telnet-Port: 23)

*Format: decimal*

### ↪ **Server IP/URL**

IP address or URL of the TCP/IP computer on which the Telnet-Server is active.

*Format: Dot notation or URL*



*A URL can only be assigned in conjunction with a valid DNS server. The name used is not allowed to contain space characters (0x20), nor can the first character be a decimal (0x2E). A server IP or URL is deleted by entering 0.0.0.0. For additional information refer to the section Menu: Setup SYSTEM → Setup TCP/IP → DNS-Server.*

To activate the Telnet-Client mode, enter the desired parameters and then press the ENTER key repeatedly to return to the main menu and save the entries using *SAVE Setup*. The message *Saving...* appears. The selected mode is shown in the *SETUP Port x* → *Port State* → *Connection State* menu; the current status of the connection can also be read at any time in this menu.

### Opening the Telnet connection

After saving the connection data the Com-Server waits to receive any serial character. This is the trigger for opening the connection.

### Closing the Telnet connection

To close the Telnet connection, use the following methods available in the Submenu *...Telnet Client* → *Special Options*.

#### ↪ Inactivity Timeout

**Default: 30**

Here you can specify the value for a timer. When the specified time expires, the Com-Server port closes the connection. The timer is reset if there is an active network connection when data are being exchanged. If no data are set within the specified time, the Com-Server port closes the connection to the TCP server. `InactivityTimeout = 0` deactivates the connection closing after a timeout.

*1 Tick: 1 second*

*Format: decimal*

#### ↪ Disconnect Char

**Default: 0**

When the Com-Server port receives the character configured here at its serial port, the Com-Server port closes the connection to the Telnet server. It is important that this value not be used within a Telnet session, since this would result in premature closing. The character itself is not sent. The factory set value is 0. `Disconnect Char = 0` deactivates this mode

*Format: decimal*

### 15.2.1 Optional settings

↪ **Serial 0D->0D00**  
**Default: 0**

If this switch is activated, an 00H is appended to the serially received character 0DH: in other words, 0DH 00H is sent over the network. This option may have to be activated for sending binary files.

Once you have entered all the parameters in the Com-Server port menu, press the ENTER key several times to return to the main menu and save the entries with *SAVE Setup*. The message *Saving...* appears, then the FDP client mode is activated. The entry *FTP-Client* now appears in the *SETUP Port x → Port State → Connection State* menu. The current status of the connection can be read in this menu at any time.

### 15.2.2 Deactivating Telnet client mode

Set the following parameters in the menu branch *SETUP Port x → TCP/IP Mode → Telnet Client* to a value of 0 and save this change:

... → *Server Port*  
... → *Server IP/URL*

Alternately you may use the function *SETUP Port x → Port State → Clear Port Mode*. The Connection State in the Submenu *SETUP Port x → Port State* must then be named *FREE*.





## **16 IP Bus mode**

Several serial Com-Server ports can be logically linked together over the network in the form of a Master-Slave bus. The connected serial terminal devices are in constant online contact in this mode. Any additional data traffic or other network protocols have no effect on the connection.

- Configuration of a bus master
  
- Configuration of a bus slave

**16.1 Function of the IP Bus mode**

The following sketch shows the Master-Slave principle of IP-Bus mode. The Com-Server configured as a master sends all received serial data via broadcast into the network. All Com-Servers configured as slaves receive these data and pass them on to the connected serial devices. In the other direction all serial data arriving at the slave Com-Servers are sent with an addressed network packet to the master Com-Server.

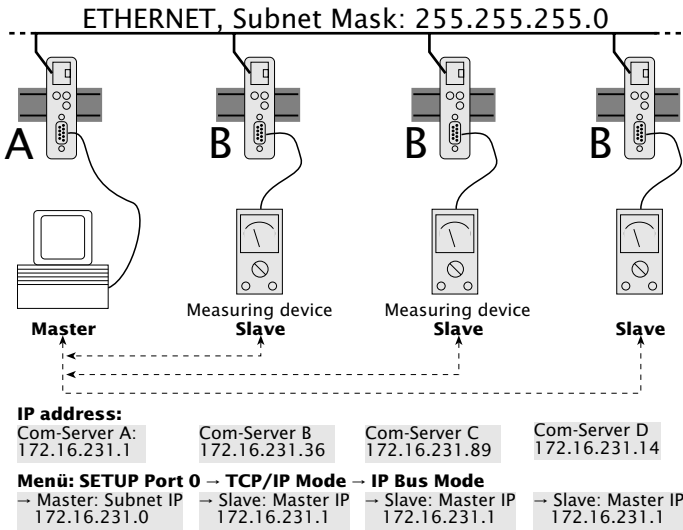

*The serial devices must send their data using their own proofing protocol. Since the Com-Servers use Internet Protocol (IP) as the network transmission protocol, they cannot ensure data integrity.*

*Since data are sent from the Master to the Slaves per broadcast, all the devices which are to comprise a bus must belong to the same subnet. This means the subnet mask and the network portion of the IP address must be identical in all the Com-Servers.*

## 16.2 Configuring the IP Bus mode



You may not configure the IP Bus mode in the same Telnet session in which the IP address, the subnet mask or the gateway address for the Com-Server was already changed. After you make such settings you must first close the Telnet connection using „q“ and then reopen it.

### 16.2.1 Activating the master

Configure the following parameters in the Submenu *SETUP Port x* → *TCP/IP Mode* → *IP Bus Mode*:

#### ↪ **Master: Subnet IP**

Enter here the network address of the subnet in which the Master and Slave are located. It is sufficient to enter a value other than zero (e.g. 1.0.0.0) and confirm with ENTER. The Com-Server processes the subnet IP address itself from its own IP number and the subnet mask (AND operation) and enters it.

### 16.2.2 Activating the slave

Configure the following parameters in the Submenu *SETUP Port x* → *TCP/IP Mode* → *IP Bus Mode*:

#### ↪ **Slave: Master IP**

Set on all Com-Server ports that are connected to Slaves the full IP address of the Com-Server having the Master port.

In both cases the change must be saved after entering the IP or subnet IP address in order to activate the mode. Press ENTER repeatedly to return to the main menu and save using *SAVE Setup*. The message „Saving..“ appears, and IP Bus Mode is activated. The entry Bus Master or Bus Slave appears in the *SETUP Port 0* → *Port State* → *Connection State* menu.

### 16.2.3 Deactivating IP Bus Mode

Set the respective IP address in the *SETUP Port x → TCP/IP Mode → IP Bus Mode* menu to zero (0.0.0.0), or use the menu *SETUP Port x → Port State → Clear Port Mode*. The Connection State in the Submenu *SETUP Port x → Port State* must then be named *FREE*.

## **17 The Com-Server as SLIP router**

SLIP router mode enables serial devices with their own TCP/IP stack to be incorporated into an Ethernet. When the Com-Servers are used in pairs, remote Ethernet segments can also be integrated into the main network in this mode using a serial standard cable.

### **■ Configuration of SLIP**

## 17.1 Configuring the SLIP mode

In this mode the Com-Servers functions as a router. All network packets whose destination address is within the configured subnet are routed over the serial interface using SLIP. All arriving serial SLIP packets are passed along to the local Ethernet network.



*You may not configure for SLIP routing in the same Telnet session in which the IP address, the subnet mask or the gateway address for the Com-Server was already changed. After you make such settings you must first close the Telnet connection using „q“ and then reopen it.*

In the Submenu *SETUP Port x → TCP/IP Mode → SLIP Router* configure the following parameters:

### ↪ **Net Address**

Enter here the network address of the serially connected subnet you want to route to via SLIP.

### ↪ **SLIP-Net Routing**

**Default: active**

If this parameter has a value of 1, the Com-Server functions as described like a router for the subnet specified under *Net Address*. If the parameter is 0, the Com-Server is transparent, i.e. all packets directed to the IP address of the Com-Server are forwarded as SLIP packets to the serial port. The destination IP address (IP address of the Com-Server) is replaced by the parameter *Net Address*. This allows you to assign individual IP addresses to the connected SLIP computers (=Net Address) without having to assign a separate subnet for each connection.



*Excluded from this procedure are packets for the Telnet configuration port 1111 of the Com-Server!*

The following sketch shows the various ways of processing the IP packets depending on the *SLIP-Net Routing* parameter.

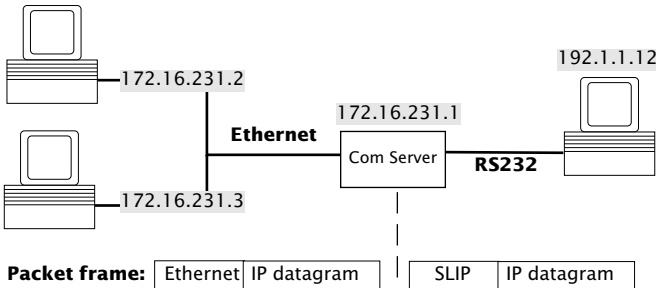

..→ **SLIP Router** → **Net Address = 192.1.1.0** / → **SLIP-Net Routing = 1**

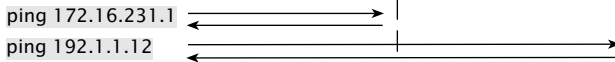

..→ **SLIP Router** → **Net Address = 192.1.1.12** / → **SLIP-Net Routing = 0**

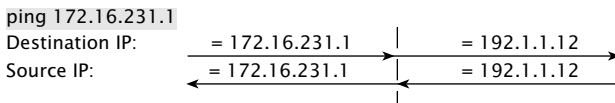

ping 192.1.1.2  
This IP address is not routed!

 Access to the network port of a Com-Server functioning as a SLIP router can take place only from a computer located in the same subnet. In the above example, this would mean that access via Telnet, browser or ping to the Com-Server in Ethernet 1 must be made from a computer also located in Ethernet 1.

### 17.1.1 Deactivating SLIP router mode

Set the parameter *Net Address* to zero (0.0.0.0) in the *SETUP Port x → TCP/IP Mode → SLIP Router*, or use the menu *SETUP Port x → Port State → Clear Port Mode*. The Connection State in the Submenu *SETUP Port x → Port State* must then be named *FREE*.

### 17.1.2 Application example

#### Connecting two IP networks over serial cable

In SLIP router mode paired use of two Com-Servers allows two IP/Ethernet networks to be connected over a serial RS232/422 cable. The prerequisite is that the two networks must belong to different IP networks.

The gateway in the TCP/IP stacks of the computer must under some conditions be configured to the IP address of the respective Com-Server. If there are additional routers in the network and these are capable of RIP protocol (**R**outing **I**nformation **P**rotocol), the routing will work without explicit configuration of the gateway address.

The serial transmission parameters for both Com-Servers must be identical. Only hardware handshake may be used for flow control. The use of software handshake is not possible due to the *Xon* and *Xoff* characters which the Com-Servers process.



*The maximum serial transmission speed is 230.400 baud. Transmission of the entire Ethernet-side bandwidth is not possible.*

The following sketch shows a sample configuration for paired use of Com-Servers as SLIP router:

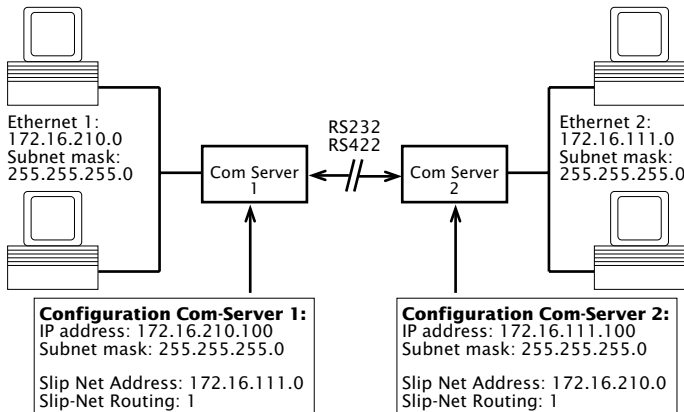



### 17.1.3 Configuring the Com-Server via SLIP

It is possible to open a UDP connection for configuring some Com-Server parameters through the serial connection between the Com-Server and the connected SIP computer.

The SLIP packets must be directed to the IP address 10.0.0.1 and UDP port 1111. These packets are not forwarded to the Ethernet, but rather are processed by the Com-Server and answered as appropriate.

The packets consist of IP and UDP headers as well as the configuration data, and are exchanged between the Com-Server and the SLIP computer per SLIP.

#### Format of the configuration data

The configuration data always start with the TYPE field, which specifies the packet type, followed by the LEN field, which specifies the length of the configuration data in bytes. Next follows a list of parameters having any length, whose content and length is indicated by a defined number (PARAM\_NO).

TYPE	LEN	PARAM_NO	PARAMETER	PARAM_NO	PARAMETER	...
BYTE	BYTE	BYTE	TYPDEF	BYTE	TYPDEF	

#### The parameter list

The following Com-Server parameters can be written and/or read:

PARAM_NO	Parameter name	Data type	RD WR
1	Setup TCP/IP → IP-Address	long (32 bit)	RD+WR
2	Setup TCP/IP → Subnet Mask	long (32 bit)	RD+WR
3	Setup TCP/IP → Gateway	long (32 bit)	RD+WR
4	Setup TCP/IP → MTU	unsigned int (16 bit)	RD+WR
5	... → SLIP Router → Net-Address	long (32 bit)	RD+WR
6	... → SLIP Router → SLIP-Net-Routing	unsigned int (16 bit)	RD+WR
16	MAC-Address	char[6] (6 bytes)	RD
17	Software-Version	unsigned int (16 bit)	RD

Parameters of data type long or unsigned int are sent in net order, with the high byte first and the low byte last.

**Packet types (byte TYPE)**

The following three packet types are used for sending configuration data:

■ **TYPE = 1: Writing parameters in the Com-Server**

This packet is sent by the SLIP computer to the Com-Server. The Com-Server carries out the configuration and deletes the packet. A packet for configuring the IP address and subnet mask would look as follows:

0	1	2	3	7	8	12
TYPE	LEN	PARAM_NO	IP address	PARAM_NO	Subnet Mask	
1	10	1	hex: AC 10 EF 1 (172.16.231.1)	2	hex: FF FF FF FF (255.255.255.0)	

■ **TYPE = 2: Request for reading parameters**

This packet is sent by the SLIP computer to the Com-Server. The Com-Server sends a response type (TYPE=3) with the contents of the requested parameters. The packet contains the fields TYPE and LEN and a list of the desired parameter numbers (PARAM\_NO). A packet for reading the MTU and the MAC address would look as follows:

0	1	2	3	4
TYPE	LEN	PARAM_NO	PARAM_NO	
2	2	4	16	

■ **TYPE = 3: Response to a request for reading parameters**

The Com-Server uses this packet to reply to a request for reading parameters (TYPE=2). It is used for sending the requested parameter contents. This packet is constructed like TRYPE 1. The reply to a request for parameters MTU and MAC address would look as follows:

0	1	2	3	7	8	12
TYPE	LEN	PARAM_NO	MTU	PARAM_NO	MAC-Adresse	
3	10	4	hex: 02 00 (512)	16	hex: 00 C0 3D 00 30 DB (00-C0-3D-00-30-DB)	

## **18 Serial Socket Interface**

The Serial Socket Interface enables defined communication between Com-Servers and the device connected to their serial port. Analogous to the TCP/IP socket interface in Windows or UNIX systems, it provides the end user with an external TCP/IP stack on the serial port while supporting up to eight logical client and/or server sockets.

### **■ Function scope of the Serial Socket Interfaces**

## 18.1 Function of the Serial Socket Interface

The Serial Socket Interface enables defined communication between Com-Servers and the device connected to their serial port. Analogous to the TCP/IP socket interface in Windows or UNIX systems, it provides the end user with an external TCP/IP stack on the serial port while supporting up to eight logical client and/or server sockets.

- ✓ Opening and closing up to 8 handles (data connections) at the same time
- ✓ Specifying the type of network connection (UDP or TCP) and the connection parameters (destination IP address and port plus local port of the Com-Server)
- ✓ Transmitting IP broadcasts
- ✓ The Com-Server independently informs the serial terminal device as part of the protocol of changes in the system or connection status
- ✓ Packet-oriented transmission of serial data in both directions, i.e. sending of packets with packet start characters, packet headers, data, packet end characters
- ✓ Transmission of the network destination address (IP address, UDP port) to the Com-Server and the network sender to the serial terminal device with the data
- ✓ Parameterizable packet frame characters (packet end/packet start) or character doubling procedure for not having to exclude characters from the stream
- ✓ Configuring the Com-Server serial port
- ✓ Configuring the Com-Server network parameters
- ✓ Reading the configurations

The detailed protocol documentation can be downloaded from our Web site (<http://www.wut.de>).

## **19 OPC data transfer**

OPC (**O**le for **P**rocess **C**ontrol) is the standard software interface for manufacturer-neutral acquisition of external data sources from within visualization and SCADA systems. Regardless of whether in process-, automation- or building technology, the W&T OPC Server takes care of TCP/IP communication with the Com-Server. Both data directions for the serial devices are represented as DA items of OPC Standard 3.0.

- OPC = **O**le for **P**rocess **C**ontrol
- Download and installation of the OPC server
- Configuration of the OPC server
- Configuration of the Com-Server
- TCP ports

## 19.1 Overview

The W&T OPC-Server Version 4 conforms to OPC *Data Access 3.0* as well as OPC *Alarms & Events 1.10*. It is implemented as a background service, whereby client connections as well are possible without any active user login on the respective computer. Configuration is file-based using the separate configuration program described in the following sections. In addition to the serial Com-Servers, the following W&T product families are also supported:

- Web-IO Digital (and Digital-E/A Com-Server)
- Web-IO Analog
- Web-IO Climate
- RFID-Server

The OLE server name which needs to be specified for the OPC clients in order to connect to the server, is *Wiesemann-Theis.Network-IO* for OPC DA and *Wiesemann-Theis.Network-Events* for OPC A&E.



*The following sections describe a quick start-up which is sufficient for many applications. More detailed information for all configuration options for the W&T OPC Server can be found in the online help.*



*This description refers to the OPC Server Version 4.00 and higher. Installation and configuration of earlier versions differs considerably in parts. If in doubt, please use the online help for the currently installed version.*

## 19.2 Download and installation of the W&T OPC server

The latest version of the W&T OPC server as well as additional tools, application descriptions and FAQs can always be downloaded from our Web site.

<http://www.wut.de>

The simplest way to navigate from there is by using the menu tree on the left side of the page. Follow the

*Downloads → Com-Servers*

path to get to the website containing a direct link to the W&T OPC server.

Use of the WT OPC server in connection with W&T products is free and not subject to any licensing requirements.

### 19.2.1 Installation/deinstallation of the W&T OPC server



System requirements for installing the W&T OPC Server:

- Operatinf system Windows NT, 2000, XP, Vista
- Login als administrator or with administrator rights



*Installation of Version 4.xx of the W&T OPC Server is done in parallel with any already existing older versions 3.xx. This means existing client projects with connections to 3.xx version OPC servers remain unaffected and may have to be manually reset for communication with the new OPC Server 4.xx.*

After downloading and unpacking the archive, start the MSI file to start installation. In addition to setting up the core driver, whereby a new program group names *W&T OPC Server Version 4* is created. This contains the following files:

- ↪  - **OPC-Server configuration**  
Configuration tool for OPC server service
- ↪  - **Minimal OPC client**  
OPC client application for testing purposes
- ↪  - **Manual**  
Online documentation and help. A context-specific start can also be done by pressing the F1 key within the configuration tool

### 19.2.2 Deinstallation of the OPC server

The W&T OPC Server is uninstalled using Windows software administration. Start the *Software* applet in the control panel and there select the entry *W&T OPC Server*. Clicking on the *Remove* button removes the OPC Server from the system.



## 19.3 Configuration of the OPC server

The OPC Server is implemented as a background service, and can be used without a user login. Configuration is file-based, whereby the configuration files contain general options and a device list. Any number of these files may be stored under any desired names. This allows you for example to preserve earlier work states or administer alternate configurations.

The configuration which the OPC Server actually uses is on the other hand stored under a pre-defined name in the Windows standard directory for common application data. It is automatically read when the configuration program is started, and as long as it is open the title line shows „Active configuration“ instead of the actual file name.



*All changes made from within the configuration tool do not become active until the menu item File → Save has been invoked as the active configuration.*

### 19.3.1 Settings on the Com-Server

Starting from the factory default setting, only the three network-specific parameters *IP Address*, *Subnet Mask* and *Gateway Address* need to be configured in order to operate the Com-Server. It is not necessary to set the serial transmission parameters such as baud rate, since these are automatically made by the OPC Server.

Only if within the OPC Server a TCP port was entered which differs from the factory default setting 8000 do you need to configure the corresponding values in the following menu branches of the Com-Server:

Data port:

*SETUP Port x → TCP/IP Mode → Local Port*

Control port (= Data port + 1094):

*SETUP Port x → TCP/IP Mode → Controlport*

### 19.3.2 Incorporating the Com-Server into the OPC Server

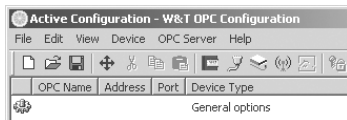

After starting the OPC configuration tool, click on the *New serial device* button to start the dialog for integrating a Com-Server:

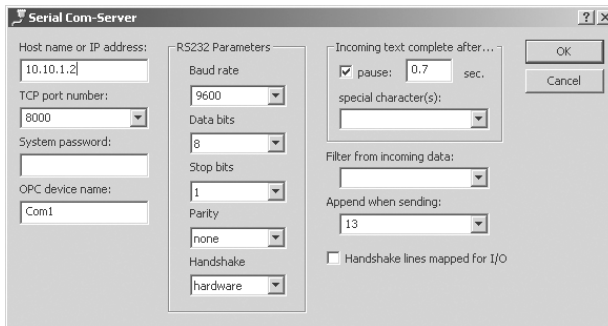

The required connection data for the Com-Server, consisting of the IP address, TCP port and system password, are entered into the corresponding fields of the following window.

The serial transmission parameters, which are also configurable here, must agree with those for the serial connected device.

### 19.3.3 Structuring the serial data

In order to be able to represent the received RS232 data for OPC as string variables, the data must first be broken down into packets. Packet limits are recognized here either based on pauses or by the occurrence of special character sequences. Character sequences are always indicated indirectly as decimal numbers.

**Examples:**

- 1.) End string: +++ → Input: 43,43,43
- 2.) End string: CRLF → Input: 13, 10

## 19.4 Serial OPC variables

The OPC Standards Data Access 3.0 (DA 3.0) and Alarm&Events (A&E) are supported by separate OPC Server instances.

If the client used does not support the browser function for servers and items available in the system, the following names must be used:

OPC server DA 3.0: *Wiesemann-Theis.Network-IO*

OPC server A&E: *Wiesemann-Theis.Network-Events*

Serial communication for each installed Com-Server takes place using the following variables. In contrast to the OPC Server names, these can be freely set using the configuration tool:

**TxD:** (VT\_BSTR, W): RS232 send data, assigned values are output over the serial port.

**RxD:** (VT\_BSTR, R): RS232 receive data (the last text packet which arrived from the serial port).

**N:** (VT\_I4, R/W): Packet counter, is incremented by 1 each time a text packet is received.

## 20 Status and error messages

- Status messages of the menu *Port State*
- Resetting a fixed mode: *Clear Port Mode*

**20.1 Menu Setup Port x – Port State**

In this menu you will find information about the configured TCP/IP mode of the Com-Server port, the status of the network connection and a listing of error which occurred. In addition, Clear Port Mode can be used to clear a fixed set mode.

↳ **Connection State**

This menu permits online connection control. The display is organized as follows:

<p>Connection State</p> <p>FREE</p>	<p>The port is in standard mode and has no connection</p>
<p>Connection State</p> <p>In Use: Port 2000 (172.016.231.001)</p>	<p>The port is in server mode and has a connection to the process having the port no. 2000 on the TCP/IP station having IP address 172.16.231.1</p> <p>→ <b>Client address</b></p>
<p>Connection State</p> <p>TCP Client DNS: [URL] = [IP address] Locked: Port 2000 (172.016.231.001)</p>	<p>The port is configured as a TCP and has connection to the server process having port no. 2000 on IP station having IP address 172.16.231.1</p> <p>→ <b>Configured TCP/IP mode</b></p> <p>→ <b>DNS result</b></p> <p>→ <b>Servers address</b></p>

- ↳ **Connection state client mode:**
- Unlock: The port is configured for the indicated mode but has **no active** connection
  - Locked: The port is configured for the indicated mode and has an **active** connection to the configured server
  - Scanning: The Com-Server wants to open a connection and **searches** for the configured server ( in "Box to Box" mode the slave- or master port ).
  - Disconnect: The Com-Server wants to open a connection but it is **refused** by the server

The display is updated by exiting and then reselecting the menu item *Connection State*..

**↳ Error State**

This list shows the errors which occurred on the port. If more than five errors have occurred since the Com-Server was last reset or since the last time the error table was cleared, the oldest entry is always overwritten. The most recent entry is in first position and the oldest in last position. Preceding each entry is the time when the error occurred in hours and minutes since the last time the Com-Server was reset. You can clear the error table in order to have all the entries available again.

**„CTS/DSR/RLSD Time Out“**

A timer value can be preset for the Com Server for each of these three serial input signals. This value begins to run when the corresponding input assumes the LOW (-12V) state and is reset as soon as a HIGH level (+12V) is present. If this does not occur within the configured time, this error message is output. The reason may be for example an unconnected, deselected, defective or improperly configured serial terminal device. The factory setting for all inputs is for no timer.

**„No halt on XOFF/RTS/DTR“**

The connected serial device does not respond to the stop signal set by the Com Server and continues to send data. The result may be overwriting of the serial ring buffer and loss of data. Please check to be sure the handshake configurations for the devices agree and the connection cable is properly wired.

**„Overrun Error“**

The data register of the serial receiver component was written even though the previous character could not be read out. Since this is a purely device-internal event, this error message is strongly indicative of a Com Server hardware error.

**„Parity Error“**

A character received on the serial port has an incorrect or missing parity bit. Please check that the transmission parameters for the Com Server and the corresponding serial terminal device are the same. Parity errors can also be caused by use of excessively long cable.

**„Framing Error“**

A character received on the serial port does not fit in the time frame that results from the configured transmission parameters (baud rate, start bit, data bits, parity bit, stop bits). Please check here also that the Com Server and serial terminal device configurations are the same.

**↪ Clear Port Mode**

Use this command to simply and easily revert the port to standard TCP/IP mode. The previously configured TCP/IP mode (TCP-, UDP-, Telnet-, FTP-Client, Box to Box, Bus IP Mode) is deleted.



*The changes made using Clear Port Mode are also effective without SAVE Setup after exiting the menu, i.e. they are saved directly in the non-volatile memory.*



## **21 Expanded services of the Com-Server**

In the preceding sections we explained all the standard processes that are implemented in the Com-Server. These client/server processes cover the majority of the application possibilities for the Com-Server. Implementation of more complex scenarios often requires however that the software be individually adapted.

For users who make use of socket programming, the Com-Server offers additional functions beyond pure data transfer.

- The control port and its data structure
- Status requests and configuration of the serial port
- Resetting the Com-Server
- Uploading/downloading of the configuration data
- Inventory taking per UDP
- SNMP management

## 21.1 The control port

The TCP client and TCP server processes for sending data to the serial port of the Com-Server do not allow influencing the serial port itself. But some applications make it necessary that the status and configuration of the port be known and capable of being changed at all times.

Parallel with the data connection on Port 8000, a control connection can be opened on Port 9094. Through this connection it is possible to read out the current status of the port (handshake lines and error states) or to despatch commands. The user data itself is only transported through the actual data connection.

Control port numbers:

The TCP connection to the control port is done using the port number stored in the menu branch *Setup Port 0* → *TCP/IP Mode* → *Control port*. The following port numbers are pre-configured at the factory:

- Port A = 9094
- Port B = 9194
- Port C = 9294
- Port D = 9394



*The control connection can only be opened if the Com-Server port functions as a TCP server or TCP client.*

The data- and control ports are independent of each other. They may be individually opened and closed whenever desired.

### Use of the system password

If a system password has been configured (see section „Basic Configuration of the Com-Server“), this must be null-terminated (= [password] + 0x00) and sent to the Com-Server via the Control Port within 2s after a connection has been successfully opened. If the Com-Server does not receive a correct or even any password within this time, it sends the

message *PASSWD?* followed by a null byte (0x00) to the client and closes the TCP connection.

If no system password is configured you can, as described below, begin with the exchange of info structures as soon as the TCP connection has been established.

### 21.1.1 The control structure

For the purpose of exchanging information and commands, data records having a defined length and structure are exchanged through this connection.

To request an info structure (completely filled data record from the Com-Server port), you only need to send any desired character to the control port. To despatch a command, the Com-Server expects the complete structure (30 bytes) in a TCP packet. If no allocatable data (e.g. just half of a structure) pass through the contro port, the reply is still an info structure. The declaration of the structures is made in C language.



*Note for all structures:*

A **word** corresponds to a 16-bit integer

A **char** corresponds to a byte (8bit)

Hex convention: **0x** preceding the value

The info structure has a fixed length of 30 bytes and is comprised of the following individual structures:

```
#pragma pack(1) //packs the structure components into 1-byte limits
typedef struct _rem_box_cntrl
{
    char        zero_1;
    COM_ERROR   _ce;
    COM_STAT    _cs;
    BOX_CNTRL   _bc;
    char        zero_2;
}
    REM_BOX_CNTRL;
#pragma pack()
```

### zero\_1/zero\_2

The two characters *zero\_1* and *zero\_2* are the start and end characters of the structure and must always be zero.

### Structure COM\_ERROR

The *COM\_ERROR* structure has a length of one WORD (16-bit integer) and contains all the error states of the serial port.

```
typedef struct _com_error
{
    union
    {
        word error_flags;
        struct _err_flags
        {
            word f_data      : 1; //not used/reserved
            word f_net       : 2; //not used/reserved
            word f_com       : 1; //Set when COM port error detected
            word f_break     : 1; //Reflect the break flag
            word f_cts_time  : 1; //Time out while waiting on CTS
            word f_dsr_time  : 1; //Time out while waiting on DSR
            word f_rlsd_time : 1; //Time out while waiting on RLSD (CD)
            word f_overrun   : 1; //Overrun error
            word f_parity    : 1; //Parity error
            word f_frame     : 1; //Framing error
            word f_status    : 1; //not used
            word no_use_1    : 1; //not used
            word no_use_2    : 1; //not used
            word f_rx_over   : 1; //Ring buffer overrun after handshake
            word no_use_3    : 1; //not used
        };
    };
}
    COM_ERROR;
```

## Structure COM\_STAT

The *COM\_STAT* structure has a length of three WORDS (16-bit integer) and contains the status of the handshake lines as well as the number of bytes which are in the send and receive buffers of the serial port. It also allows you to directly influence the handshake lines and buffer.

```
typedef struct _com_stat
{
    union
    {
        word com_flags;
        struct _com_flags
        {
            word cts_hold   :1; //CTS line                - LowByte
            word dsr_hold   :1; //DSR line                |
            word ri_hold    :1; //not used/reserved        | is set with every
            word rlsd_hold  :1; //reserved/reserved        | received packet
            word dtr_hold   :1; //DTR line                |
            word rts_hold   :1; //RTS line                |
            word x_receive  :1; //XOFF received            |
            word x_send     :1; //XOFF was send            -

            word break_mode :1; //1 = set_break was set-   - HighByte
                               //0 = clear_break was set |
            word dummy      :1; //not used                |
            word send_xoff  :1; //Send XOFF asynchron      |
            word flush_rd   :1; //Flush serial input buffer |
            word flush_wr   :1; //Flush serial output buffer |
            word set_rts_dtr:1; //set RTS to rts_hold and |
                               //DTR to dtr_hold         |
            word set_break  :1; //Independent setting break mode |
            word clear_break:1; //Independent clearing break mode -
        };
    };
    word cbInQue;           //Receive byte count of COM ring buffer
    word cbOutQue;         //Transmit byte count of COM ring buffer
} COM_STAT;
```

## Flushing buffers and influencing the handshake:

- 1) Copy the complete structure of an info packet received by the Com-Server port and fill in the HighByte of the *COM\_STAT* structure.
- 2) All commands whose flags have the value 1 are executed. If you set the flag *set\_rts\_dtr*, be sure that you also set the flags *rts\_hold* and *dtr\_hold* in the LowByte correspondingly as well.



Depending on how the Com-Server and the `box_cntrl.f_flags` structure are configured, the RTS and DTR signals will be used for a LOCK/UNLOCK display or for serial flow control. In this case the Com-Server itself takes over control of these pins. The command flag `set_rts_dtr` should therefore be used only for the following setting of the `box_cntrl.f_flags` structure:

`f_rts_disable` and `f_dtr_disable` = 1  
`f_inx_dtr` and `f_inx_rts` = 0

### **Sending a break signal**

The `set_break/clear_break` flags can be used to activate/deactivate break mode and send a break signal to the serially connected device. Activated break mode is signaled by `break_mode=1`. When creating the break signal, a distinction between the various Com-Server models needs to be made as follows:

#### ↳ **58631, 58431, 58651**

With these models, break mode is first set using `set_break`. Then with each following serial character to the *data connection* the Com-Server sends a baud rate-dependent BREAK signal (approx. 10 bit times). Setting `clear_break` deactivates break mode and reestablishes normal transmission mode.

#### ↳ **58633, 58031, 58034, 58231**

After setting `set_break`, break mode is activated and a baud rate-dependent break signal is generated. The level of the data output remains inverted until break mode is deactivated again by setting `clear_break`.

## Structure BOX\_CNTRL

The *BOX\_CNTRL* structure (20 bytes) is used to store the port configuration (baud rate, data bits, parity, stop bits, handshaking, timing values, etc.). Here you can influence the parameters and how they are saved.

```
typedef struct _box_cntrl
{
    struct_baud_fifo
    {
        char baud          :5; //Baud rate for channel
                                // 11 = 230400  6 = 2400
                                // 14 = 153600  7 = 1200
                                // 15 = 115200  8 = 600
                                // 0 = 57600   9 = 300
                                // 1 = 38400   10 = 150
                                // 2 = 19200   16 = 110
                                // 3 = 9600    12 = 75
                                // 5 = 4800    13 = 50
                                // Baudrates are coded within the first 5 bits
        char fifo_aktiv :1; // 0 = FIFO disabled, 1 = FIFO enabled
        char fifo       :2; // Send/Receive FIFO trigger
                                // 0 = 8 / 8
                                // 1 = 16 / 16
                                // 2 = 32 / 56
                                // 3 = 56 / 60
                                // models 58631 and 58431 have a fix FIFO
                                // trigger so they ignore these bits
    };

    char bits; //000x.xxxx data bits, stop bits, parity
                // 10 = 7 data bits
                // 11 = 8 data bits
                // 0 = 1
                // 1 = 1½, 2 stop bits
                // 1 = parity enable
                // 0 = odd, 1 = even parity

    word RLS_time_out; //Timer before f_rlsd_time will be set
    word CTS_time_out; //Timer before f_cts_time will be set
    word DSR_time_out; //Timer before f_dsr_time will be set
    char XONChar; //Char excepted as XON
    char XOFFChar; //Char excepted as XOFF
    word hs_on_limit; //if number of free bytes in ring buffer
                    // > hs_on_limit then clearing handshake stop
    word hs_off_limit; //if number of free bytes in ring buffer
                    // < hs_off_limit then setting handshake stop
    char PEChar; //Replace this char if serial parity error (function
                //first must enabled by setting f_flags.f_pechar= 1)

```

```

struct _commands
{
    unsigned char save_command :4;    //Save COM-Configuration
                                     //0 = no save
                                     //1 = save without EEPROM Update
                                     //2 = save with EEPROM Update
    unsigned char clear_error  :1; //1 = clear error in display/lamps
    unsigned char set_fact_def :1; //1 = set factory defaults and reset
    unsigned char free_cmd     :2; //not used
};

union
{
    word hs_flags;
    struct _hs_flags
    {
        word f_cts_connect  :1; //Connect/Disconnect with CTS (HIGH/LOW)
        word f_dsr_connect  :1; //Connect/Disconnect with DSR (HIGH/LOW)
        word f_cts_accept   :1; //Accept Connection only by CTS=HIGH
        word f_dsr_accept   :1; //Accept Connection only by DSR=HIGH
        word no_use0        :12; // not used
    };
};

union
{
    word f_flags;
    struct _f_flags
    {
        word f_rts_disable  :1; //RTS will not change at LOCK/UNLOCK
        word f_dtr_disable  :1; //DTR will not change at LOCK/UNLOCK
        word f_outx         :1; //Enable softw. handshake while sending
        word f_inx          :1; //Enable softw. handshake while receiving
        word f_outx_cts     :1; //Enable hardware handshake on CTS
        word f_outx_dsr     :1; //Enable hardware handshake on DSR
        word f_inx_dtr      :1; //Enable hardware handshake on DTR
        word f_inx_rts      :1; //Enable hardware handshake on RTS
        word f_parity       :1; //Enable parity check & error report
        word f_pechar       :1; //Enable replacement of received char
        word f_inxfilter    :1; //Enable xon/xoff filter while receiving
        word f_outxfilter   :1; //Enable xon/xoff filter while sending
        word f_rts_default  :1; //1 = While RTS is not used, RTS is active
        word f_dtr_default  :1; //1 = While DTR is not used, DTR is active
        word f_user_time    :1; //not used
        word clr_err_char   :1; //1= If Com-Server is in client mode,
                                //serial chars with framing or parity
                                //errors will not open the connection
    };
};
} BOX_CNTRL;

```

## Configuring the serial port

1. Copy the complete structure of an info packet received by the Com-Server and fill in the BOX\_CNTRL structure. This allows you to read out the default values and only enter the values you want to change.



2. To work with the configuration, the value *save\_command* in the structure has to be set. "*save\_command* = 2" causes the Com-Server to save this configuration in non-volatile memory and to use it again after a restart. A 1 does not overwrite the non-volatile memory, i.e. after a restart the old configuration is used.

### Functions of the RS232 outputs RTS and DTR

If the flags *f\_rts\_disable* and *f\_dtr\_disable* are set to 0, the corresponding RS232 output uses an enable level to signal to signal an active connection between the serial port and a client in the network. If the Com-Server itself is configured as a TCP client, a constant enable level is output, regardless of whether there is an active connection or not.

Alternately a 1 in the flags *f\_inx\_rts* and *f\_inx\_dtr* can assign the function of serial flow control to the respective RS232 output. If flow control is enabled, the corresponding flag for the *LOCK/UNLOCK* display must have the value 1 (= *LOCK/UNLOCK* display disabled).

If the respective RS232 output does not have the function of either *LOCK/UNLOCK* display or flow control, the flags *f\_rts\_default* and *f\_dtr\_default* can be used to specify the default state after a Com-Server reset (1=Enable, 0=lock level).

## 21.2 Reset Com-Server-Port

For special applications this port makes it possible to carry out a forced reset of the Com-Server port: The parameters for the current connection are deleted, and the current connection partner (host) is notified by means of a *TCP/IP RST*.

TCP port numbers:

- Port A = 9084
- Port B = 9184
- Port C = 9284
- Port D = 9384

### Example:

The TCP/IP station having address 172.16.231.100 has a connection to the TCP server (Port 8000) of the Com-Server having IP address 172.16.231.8. The host fails or is disconnected due to a cable break. The Com-Server port remains blocked as long as the TCP/IP station does not report.

To reset this port for a new connection, a *connect()* must be made to Port 9084 of the Com-Server. The Com-Server will accept the connection and immediately initiate a *close()* (close the connection). At the same time it sends a RESET signal to TCP/IP station 172.16.231.100 and deletes its parameters.

The next *connect()* to Port 8000 is now replied to by the Com-Server.

### Use of the system password

If a system password has been configured (see section „Basic Configuration of the Com-Server“), this must be null-terminated (= [password] + 0x00) and sent to the Com-Server via the Control Port within 2s after a connection has been successfully opened. If the Com-Server does not receive a correct or even any password within this time, it sends the message PASSWD? followed by a null byte (0x00) to the client and closes the TCP connection.

If no system password is configured, then as the example shows the Com-Server immediately closes the TCP connection as soon as it has been established and performs a port reset.



*When invoking this service, the contents of the serial in- and output buffer are lost. The port can be opened by any desired station and should only be used in extreme cases! No data are permitted to be transported through this connection! The port is opened by a host and then immediately closed by the Com-Server.*

### 21.3 Software reset of the Com-Server

Socket 8888 has been implemented in case the Com-Server ever needs to be completely reset. If a connection is opened on this port, the Com-Server immediately closes it again and then performs a software reset.

#### Use of the system password

If a system password has been configured (see section „Basic Configuration of the Com-Server“), this must be null-terminated (= [password] + 0x00) and sent to the Com-Server via the Control Port within 2s after a connection has been successfully opened. If the Com-Server does not receive a correct or even any password within this time, it sends the message *PASSWD?* followed by a null byte (0x00) to the client and closes the TCP connection.

If no system password is configured, then as the example shows the Com-Server immediately closes the TCP connection as soon as it has been established and performs a port reset.



*Following this reset all the buffer contents are deleted and any still active connections are closed - the Com-Server is in its base state! This reset can be performed from any station and should be done only in extreme cases!*

## 21.4 Uploading/downloading configuration data

(Port numbers 8003/read, 8004/write)

These services allow you to read out the configuration data for the Com-Server stored in the non-volatile memory and send it to another Com-Server. Especially when installing a large number of Com-Servers having the same settings this method eliminates having to open a Telnet configuration connection for each individual unit.

### Use of the system password

If a system password has been configured (see section *Basic Configuration of the Com-Server*), this must be null-terminated ( $=[\textit{password}] + 0x00$ ) and sent to the Com-Server via the Control Port within 2s after a connection has been successfully opened. If the Com-Server does not receive a correct or even any password within this time, it sends the message `PASSWD?` followed by a null byte ( $0x00$ ) to the client and closes the TCP connection.

If no system password is configured, the Com-Server expects or sends the configuration data directly after the TCP connection has been established.

### Reading out the configuration data on port 8003

All the client application needs to do is open a TCP connection to Port 8003 of the Com-Server. The Com-Server accepts it, automatically sends its 1024-byte long configuration and then closes the connection to the client.

The client application can store this data now in a binary file and use it for downloading to other Com-Servers.

### Writing configuration data on port 8004

Uploading to a Com-Server is analogous to reading out the configuration data. After opening a TCP connection to Port 8004 of the Com-Server, the latter expects the 1024 bytes for a new configuration. After the client closes the TCP connection, the Com-Server saves the data in its non-volatile memory and performs a reset.

The value of the IP address remains unaffected by a configuration upload.

### Application

To operate multiple Com-Servers having the same configuration, you must first assign each unit with its own IP address. Then use Telnet to fully configure a Com-Server with the desired parameters and use Port 8003 to read the non-volatile memory out. The file thus created can now be uploaded to the remaining Com-Servers.



*The procedure described here is a substitute for the relatively time-consuming configuration using a Telnet session. All the settings are saved in the non-volatile memory and are still available after a reset or power loss. Only a factory default reset overwrites the settings assigned by the factory set standard values.*

#### 21.4.1 Uploading/downloading under Windows

For Windows computers you can also up- or download the configuration data using the W&T tool, which is also used for the firmware update. You can find a corresponding download link on the Web data sheet pages for the Com-Servers at the following address: <http://www.wut.de>

## 21.5 Inventory taking per UDP/8513

Larger installations often require that an inventory be taken of all the Com-Servers currently in the network. This can be done using UDP Port 8513. After receiving a network packet directed to this port, the Com-Server replies to the respective sender with an info packet. This contains the network-relevant basic parameters as well as information such as the current connection status.

Whether a packet was received by a Com-Server per broadcast or directly addressed to it makes no difference in generating the info structure. The only factor is that UDP-Port No. 8513 is used.



*For reasons of downward compatibility, the Com-Servers continue to support the previous UDP infoport 8512. In new applications however you should use only Port 8513 as described here.*

### 21.5.1 The infopacket

Each infopacket consists of 3-6 data structures. *BOX\_VERSION* contains information on the respective model of the Com-Server and its firmware status. The structure *BOX\_DESCRIPTOR* provides the network-relevant data such as MAC- and IP-address. The 3.-6. structure *PORT\_DESCRIPTOR* provides information about the configured mode and the current connection status of the individual ports. The total length of the InfoPacket is calculated as follows:  $10 + 22 + (\text{port\_no} \times 10)$  bytes.

```

#pragma pack(1)

typedef struct _BOX_VERSION          // ( 10 byte )
{
    unsigned int version;           // 0x10: 1.0 (Version of this structure)
    unsigned int sw_rev;            // z.B. 1.24 (0x1501)
    unsigned int hw_rev;            // C2_EURO           = 2.0 (0x0002)
                                    // C3_PC104          = 3.0 (0x0003)
                                    // C4_MINI           = 4.0 (0x0004)
                                    // C5_100BT         = 5.0 (0x0005)
                                    // C6_INDUSTRY      = 6.0 (0x0006)
                                    // C8_LOW_VOLTAGE   = 8.0 (0x0008)

    unsigned int reserved[2];
}BOX_VERSION;

typedef struct _BOX_DESCRIPTOR       // ( 22 byte)
{
    unsigned char mac_addr[6];      // Com-Server MAC address
    unsigned long IP_number;        // Com-Server IP address
    unsigned long gateway;          // Gateway
    unsigned long subnet_mask;      // Subnet Mask
    unsigned int  MTU;              // MTU
    unsigned int  port_anz;         // Number of Com-Server ports
}BOX_DESCRIPTOR;

typedef struct _PORT_DESCRIPTOR     // ( 10 byte )
{
    union
    {
        unsigned int wState;
        struct _new_type
        {
            unsigned char port_type; // 0x01 = serial port (serial CPU port)
                                        // 0x02 = serial port (UART port)
                                        // 0x03 = reserved
                                        // 0x04 = Digital E/A
                                        // 0x05 = Analog E/A (under construction)
                                        // 0x06 = W&T Dual Port RAM

            unsigned char state;       // 0=free, 1=connect, 2=waits
        };
    };

    unsigned int mode;              // 0x0001 = TCP client
                                    // 0x0002 = TELNET client
                                    // 0x0003 = FTP client
                                    // 0x0004 = Box2Box client (active)
                                    // 0x0005 = UDP Send/ReceiveMode
                                    // 0x0006 = MULTI PORT (DPRAM, SERIAL PROTOCOL)
                                    // 0x0007 = SNMP agent
                                    // 0x0008 = Box2Box server (passive)
                                    // 0x0010 = SLIP router
                                    // 0x0020 = PPP router (under construction)
                                    // 0x0030 = Box2Box bus system: Slave Box
                                    // 0x0040 = Box2Box bus system: Master Box

    unsigned long remote_IP;        // if state == CONNECT, else 0
    unsigned int  remote_port;      // if state == CONNECT, else 0
}PORT_DESCRIPTOR;

```



```
typedef struct _WT_INTERN3          // ** all parameters in Hostorder / Low Byte First **
{
    BOX_VERSION    bv;           // Port = UDP_BOX_INFO_8513
    BOX_DESCRIPTOR bd;
    PORT_DESCRIPTOR pd[ACT_PROCESS];
} WT_INTERN3;

#pragma pack()
```



*All variables of types Integer and Long are mapped in host order, i.e. the low-value bytes come first. The IP address 172.17.2.3 appears for example in byte order 3, 2, 17, 172.*

*UDP packets are connectionless and unsecure datagrams. Especially when using broadcasts the Com-Server's own request as well as reply packet can get lost. To reliably ascertain all the Com-Servers installed in a subnet you should therefore repeat the broadcast if necessary.*

## 21.6 SNMP management

Many networks are managed through a central network management system via SNMP protocol. A full description of the Management Information Base (MIB) of the Com Server would exceed the limits of this Manual. Documentation including the ASN.1 file is available for downloading at our Web site.

### Where do I obtain the MIB file?

The latest version of the private MIB as well as other tools, application descriptions are always available at

*<http://www.wut.de>*

The simplest way to navigate from there is by using the product overview on the left side of the page. Follow the

*Downloads -> Com-Server*

path to get to the menu branch containing a direct download link for the MIB.



*If a system password was configured in the Com-Server, queries from SNMP managers are only answered if the community contained there corresponds to the system password.*

## **22 Firmware update of the Com-Server**

Since the operating software is under constant development, this device also allows you to perform a firmware update. The available upload variations are described here.

- Where do I get the current firmware?
- Network firmware update unter Windows
- Network firmware update under UNIX

## 22.1 Where do I get the current firmware?

The most current firmware including update tools and a revision list is published on our Web site at the following address:

<http://www.wut.de>

From there it is easiest to navigate using the Search function located on the left side. In the entry field first enter the model number of your device. Select *Firmware* in the associated selection box and click on the *Go* button.

Search    
 for Prod. no.:

This takes you directly to the page with the most up-to-date firmware for your Com-Server model.

If you do not know the model number, you can find it on the sticker located on the narrow side of the enclosure, likewise the Ethernet address.

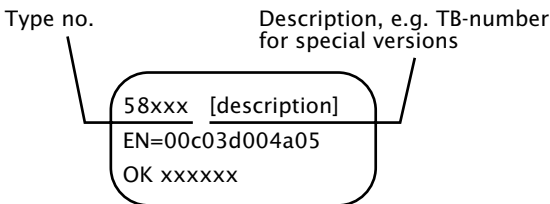

**⚠** *In particular if the sticker indicates an TB number as the part number, it is possible that the Com-Server has a special, customer-specific firmware or configuration. This would be overwritten by uploading the standard firmware. Please contact the responsible administrator in such cases before the update.*

## 22.2 Network firmware update under Windows

Required is a PC running Windows 9x/NT/2000/XP with a network connection and activated TCP/IP stack. For the update process you need two files which, as already mentioned, are available for download from our Web site at <http://www.wut.de>.

- The executable update tool for transferring the firmware to the Com-Server.
- The file with the new firmware for transferring to the Com-Server.

It is not necessary to do any special preparation in the Com-Server for a firmware update. You only need to close all data, control and configuration connections.

The update tool is for the most part self-explanatory. Should you have any questions, however, please refer to the associated documentation or use Online Help.



*Never interrupt the update process by pulling the power plug or pressing the reset button. The Com-Server will be non-operational after an incomplete update.*

## 22.3 Network firmware update under UNIX

Required is a computer with a network connection and a TCP/IP stack that provides Telnet and TFTP network protocols. When updating with TFTP protocol the firmware is split into 6 files that are sent to the Com-Server one after the other.

1. Start the remote configuration tool of the Com-Server over Telnet

```
telnet [IP address] 1111
```

In the *SETUP:* menu select *System* → *Flash Update* → *Net Update* and confirm with *y*. The Com-Server closes the Telnet connection. The green Status LED indicates that the Com-Server is in update mode.

2. Now use the TFTP command to send the first file in binary mode to the Com-Server. While the data are being sent over the network the Status LED will be on. Then the Com-Server goes into programming mode and the Error LED comes on. This process may take several seconds. Wait until the Error LED goes off and the Status LED comes on again. Repeat this process for all six files.
3. The Com-Server recognizes when all files have been sent and independently does a restart. If the green Status LED comes on again after all the files have been sent, repeat Step 2 again in full. Sending a file twice does not result in an update error. The Com-Server waits until all the necessary files have been sent.
4. Check the configuration menu of the Com-Server to make sure it took the new operating software. The version number of the new firmware should now be seen in the *INFO Com-Server* → *SOFTW Date/Rev* menu.  
If the previous version is still displayed, then one or more of the files with the new operating software is corrupted. Please use our Hotline to get in touch with us.

**Example: SCO UNIX**

Enter the following commands after the corresponding prompt:

```
# tftp
tftp> connect [ip_number|host_name]
tftp> binary
tftp> put Cxr1_1.4_1 [remote filename] (remote filename = any letter)
```

Now wait until the green Status LED comes on again. Then use the *put* command to send the remaining files, and close the TFTP connection.

```
tftp> quit
```

```
#
```



*Never interrupt the update process by pulling the power plug or pressing the reset button. The Com-Server will be non-operational after an incomplete update.*

*Never mix files having different version numbers in the file name. This will cause the unit to malfunction.*

*Send all the files one after the other. The Com-Server recognizes when all the files have been sent and that the new operation software is complete. It then performs an autonomous reset.*





## **Appendix**

- TCP/IP activation under Windows
- Overview of the port numbers
- Example: Serial assignment of the IP address under Windows
- Web applications HTTP,SMTP, POP3 ...
- Technical Data

## TCP/IP under Windows 9x

To activate TCP/IP you need a computer having a network card and Windows 9x. TCP/IP is bundled with Windows 9x, so it only needs to be configured for the local network.

- Obtain a valid IP address from your network administrator.
- Go to the *Start* menu and select the submenu *Settings* → *Control Panel* → *Network*.
- Select the *Configuration* tab and *Add*, then *Protocol* and *Manufacturers: Microsoft* and *Protocol: TCP/IP*.
- Click on *OK*. This returns you to *Configuration*, and TCP/IP will now appear in the list of network components.
- Select *TCP/IP*, and click on *Properties*. On the *IP Address* tab enter the IP address for this computer as well as the subnet mask of the network in which it is located.

If you also want to have connections to other networks, use the *Gateway* tab to enter the IP address or the gateway through which you want to route your connections.

If you have only a local network and are not using gateways or routers, a few simple rules will apply to the subnet mask. Note the first place in the IP address and select the subnet mask accordingly:

1 - 126:	255.0.0.0
128 - 191:	255.255.0.0
192 - 254:	255.255.255.0

- Confirm with *OK*. You are now prompted to insert the Windows 9x CD. The drivers are updated, after which you must restart the computer in order to activate the new configuration.

## TCP/IP under Windows NT

To activate TCP/IP you need a computer having a network card and Windows NT. TCP/IP is bundled with Windows 9x, so it only needs to be configured for the local network.

- Obtain a valid IP address from your network administrator.
- Go to the *Start* menu and select the submenu *Settings* → *Control Panel* → *Network*.
- Select the *Protocols* tab and *Add*, click on *Add* and then select *TWCP/IP Protocol* from the list.
- Click on *OK*. You will be asked whether you want to use a DHCP server for assigning the IP address. Check with your network administrator, or answer with *NO*. Now insert your Windows NT CD to install the required drivers.

After this you will be back on the *Protocols* tab. In the list of network components you will now find the entry *TCP/IP Prptocol*. Now click on *Close!*

- The links are updated and the properties window for TCP/IP appears. Enter here an IP address which is valied for this network. The subnet mask. is automatically determined from the IP address.

If you want to have connections to other networks as well, you must also etner the subnet mask specified for your network and a standard gateway. Obtain this information as well from your system administrator.

- Confirm with *OK* and restart the computer to activate the configuration.

**Used ports and network security**

The port numbers factory set in the Com-Server:

Port number	Application	Password protection?	Configurable?
6000, 23 (TCP)	Telnet server port A	no	no
6100 (TCP)	Telnet server port B	no	no
6200 (TCP)	Telnet server port C	no	no
6300 (TCP)	Telnet server port D	no	no
7000, 21 (TCP)	FTP server port A	no	no
7100 (TCP)	FTP server port B	no	no
7200 (TCP)	FTP server port C	no	no
7300 (TCP)	FTP server port D	no	no
8000 (TCP)	Socket server port A	no	yes
8100 (TCP)	Socket server port B	no	yes
8200 (TCP)	Socket server port C	no	yes
8300 (TCP)	Socket server port D	no	yes
1111 (TCP)	TELNET configuration port	yes	no
9094 (TCP)	Control port Port A	yes	yes
9194 (TCP)	Control port Port B	yes	yes
9294 (TCP)	Control port Port C	yes	yes
9394 (TCP)	Control port Port D	yes	yes
9084 (TCP)	Reset port status port A	yes	no
9184 (TCP)	Reset port status port B	yes	no
9284 (TCP)	Reset port status port C	yes	no
9384 (TCP)	Reset port status port D	yes	no
8888 (TCP)	Reset Com-Server	yes	no
8002 (TCP)	Initialize Firmware update	yes	no
8003 (TCP)	Read the configuration data	yes	no
8004 (TCP)	Write the configuration data	yes	no
8512 (UDP)	Inventory (replaced through port 8513)	no	no
8513 (UDP)	Inventory	no	no
161 (UDP)	SNMP	yes	no



*Each port number may be used for just one service in the Com-Server. If differing numbers are used for changeable ports, be sure that these are not assigned in duplicate.*

### **The Com-Server and network security**

Network security has rightly taken on added significance in recent times. All the experts are in agreement that there can be no such thing as absolute security given today's level of technology. Every customer must decide for himself what the appropriate balance is between security, functionality and cost for his specific circumstances.

In order to provide the customer with the greatest possible flexibility which is oriented towards changing security requirements from a pure testing and installation environment to critical production applications, the safety measures have been made highly customer-configurable. The present document provides an overview of the safety measures which have been implemented and can be used on the Com-Servers. It is presumed here that the original W&T firmware (without any customer modifications) is being used. Additional details can be found in the respective sections of this manual.

### **The authorization concept of the Com-Server**

Control and configuration access to the Highspeed Com-Servers is protected by the system password. The factory default setting is for no system password, so that anyone logging in has full access to the corresponding settings and functions. To prevent unauthorized access, it is therefore recommended that a system password be used. Additional measures in this regard, such as the composition and regular changing of this password, should be taken by the customer in an organizational way.

The system password is transmitted to the Com-Server without encoding. It must therefore be ensured if necessary that password-protected access can be gained only over an Intranet which the customer deems to be safe. For access over the public Internet, additional measures such as the addition of a

VPN tunnel (Virtual Private Network) should be taken. This is however a general issue for network security for which each customer must find the appropriate solutions.

### **Ports with special functions**

In addition to access over Telnet or Web Based Management, there are a variety of functions which can be activated over various TCP or UDP ports. These are shown in the previous table. Details can be found in the indicated sections of this manual.

- **SNMP**

(see section on *SNMP-Management*)

In order to be able to incorporate the Com-Servers into an SNMP-based network management, all the essential configuration settings are also accessible via SNMP. This access is protected in that the system password must be used as a community string.

- **Inventarisierungstool**

(see section on *Inventorying via UDP*)

Like all intelligent components from W&T, the Com-Servers can be accessed through the WuTility tool. Information is read from UDP ports 8512 and 8513. The ports cannot be turned off. No writing can be done over this path.

- **Firmware-Update**

(see section on *Firmware-Update of the Com-Servers*)

Initialization of a firmware update takes place on the system password-protected TCP port 8002. Only the operating system of the Com-Server is updated after a firmware update. The configuration data (IP address, gateway, serial parameters, modes, etc.) are retained.

- **Reading/writing the configuration data**

(see section on *Up-/Download of the configuration data*)

The WuTility tool as well as a customer's own applications can be used to read from and write to Com-Servers. Both of

the TCP ports 8003 and 8004 used for this are protected by the system password.

- **Com-Server Reset and Port Reset**

(see section on *Reset Com-Server-Port* and *Reset the Com-Servers*)

The TCP ports 8888, 9084, 9184, 9284 and 9384 allow for resetting of fixed modes of a port and for fully resetting the Com-Server. All the ports are not configurable and are protected by the system password.

- **Controlport**

(see section on *The Control Port*)

The TCP control ports (factory defaults 9094, 9194, 9294 and 9394) allow the COM port redirector as well as a customer's own applications to configure the serial transmission parameters and control lines of the individual serial ports on a Com-Server. All ports are protected by the system password.

## Serial assignment of the IP address under Windows

Serial assigning of the IP address and even the subnet mask and gateway address can be done using the free mini-terminal program „Easyterm“, which has been optimized especially for this task. Alternately of course you can use any other terminal program such as that included with Windows or Hyperterminal as described here.

### Easyterm

The most current version of the tool can be downloaded from our Web site at <http://www.wut.de>.

The simplest way to navigate from there is by using the product overview on the left side of the page. Follow the

*Downloads -> Com-Server*

path to get to the menu branch containing a direct download link for the tool.

After starting the program, you must simply select the COM port the Com-Server is connected to from the lower pull-down menu and then click on the Open button. All serial transmission parameters are already preset.

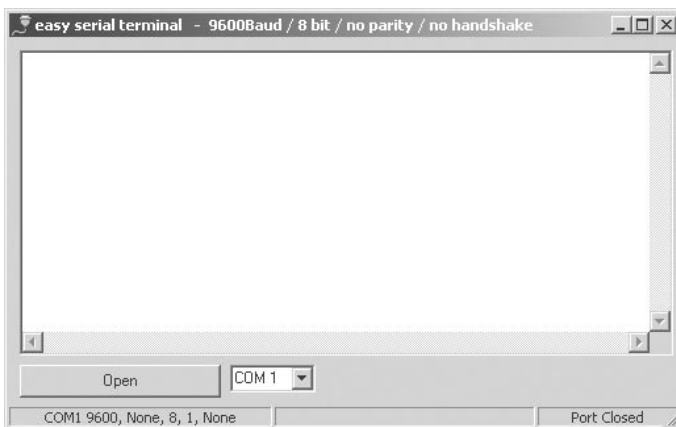



Now turn the Com-Server on and off to reset it and while it is starting up hold down the „x“ key (lower case, no Caps Lock!). After about 2-3 seconds the prompt *IP no.:+<ENTER>*: will appear in the terminal window.

Now enter the IP address you want to assign in the usual dot notation (e.g. 172.17.10.10). There will be no immediate echo of characters, so the individual inputs will not be seen on the monitor. Only after you have pressed Return to confirm is the completely entered IP address returned by the Com-Server.

Each separated by a comma, this method can also be used to assign subnet mask and gateway address.

### Example 1

Assigning only the IP address:

```
172.15.222.5 <ENTER>
```

### Example 2

Assigning IP address, Subnet Mask, Gateway:

```
172.15.222.5,255.255.0.0,172.15.222.1 <ENTER>
```

### Example 3

Assigning IP address, Subnet Mask, Gateway and deactivating BOOTP at the same time:

```
172.15.222.5,255.255.0.0,172.15.222.100-1 <ENTER>
```

### Example 4

Assigning IP-Address, Subnet Mask, Gateway , deactivating BOOTP and activating Web Based Management on TCP-Port 80 at the same time

```
172.15.222.5,255.255.0.0,172.15.222.100-1+w80 <ENTER>
```



*If you have made improper entries or typing mistakes, the Com-Server will return FAIL followed by its actual current IP address. The procedure must then be repeated.*

## Hyperterminal

To serially assign the IP address you can also use Hyperterminal, which is bundled with Windows. Start this procedure under *Start* → *Programs* → *Accessories* → *Hyperterminal*.

- 1.) In the first window you assign a name for the connection you wish to build. this allows you to directly start Hyperterminal with the correct transmission parameters the next time you want to assign an IP address:



- 2.) In the lower selection box of the following window please select only the COM port to which the Com-Server is connected.



- 3.) The transmission parameters are 9600 baud, 8 data bits, no parity, no protocol:

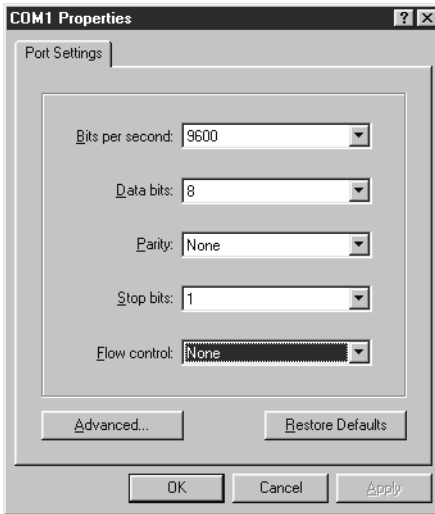

4. After you have confirmed the settings with OK, you will find yourself in the actual terminal window. All keyboard entries are output through the selected COM port. Now turn the Com-Server on and off to reset it and while it is starting up hold down the „x“ key (lower case, no Caps Lock!). After about 2-3 seconds the prompt *IP no.:+<ENTER>* will appear in Hyperterminal.
5. Now enter the IP address you want to assign in the usual dot notation (e.g. 172.17.10.10). There will be no immediate echo of characters, so the individual inputs will not be seen on the monitor. Only after you have pressed Return to confirm is the completely entered IP address returned by the Com-Server.



*If you have made improper entries or typing mistakes, the Com-Server will return FAIL followed by its actual current IP address. Step 4 must then be repeated.*

## Web application HTTP, SMTP, POP3 ...

TCP/IP protocol is the basis for all applications used in the Internet. As in the case for example of HTTP, SMTP or POP3 these are often relatively simply constructed, non-time critical ASCII protocols which are sent within the TCP data range. Distinctions are made among the individual services by using the respective TCP port number. A Web browser uses for example HTTP protocol under port number 80 for connecting to a Web server.

The freely configurable local port number of the Com-Server (see *Configuring the TCP/IP modes*) allows your own serial devices to be made Web-compatible with relatively little programming effort. The complicated lower protocol layers Ethernet, IP and TCP are fully handled by the Com-Server. Higher order protocols contained here are sent transparent to the serially connected device for further processing.

### Example HTTP

When a Web browser requests a particular site, the sequence as far as the network is concerned is as follows:

- Resolve the specified URL into the IP address using DNS
- Build and establish a TCP connection on Port 80 (=HTTP)

Both steps are done without any help from the serial terminal device using the TCP/IP stack of the Com-Server. Only now is the desired Web site retrieved using HTTP protocol, which the Com-Server passes along transparently. Specifically the serial device receives the following string:

```
HTTP 1.1 GET /filename [CR/LF]
n Options [CR/LF]
[CR/LF]
```

In the simplest case it is now sufficient to return the desired data after processing the file name and then close the TCP connection. There are two ways to close the connection: per

RS232 control line (see *Configuring the RS232 parameters (Menu: UART Setup)*) or using a timeout (see *TCP Client mode (Menu: TCP Client)*).

For additional information and examples for integrating your own serial devices into the Web using the Com-Server, see our Web site at <http://www.wut.de>.



*If the Web Based Management is activated in the Com-Server, the TCP port number configured for this cannot be used at the same time for connecting a serial device.*

## **WuTility - Inventory and management tool**

In Windows environments the WuTility Tool can also be used for inventory and management of Com-Server installations. Pressing a button lists all the Com-Servers located in the local network together with their key data. Following are the most interesting functions which can be run directly from the list:

- ✓ Assigning the IP address, even if the currently set address does not fit in the local network
- ✓ Copying of entire configuration blocks from one Com-Server to any other
- ✓ Creating and archiving configurations
- ✓ Firmware updates

### **Where do I obtain this tool?**

The latest version is always published on our Web pages at the following address:

*<http://www.wut.de>*

The simplest way to navigate from there is by using the product overview on the left side of the page. Follow the

*Downloads -> Com-Server*

path to get to the menu branch containing a direct download link for the tool.

## Hardware reset to factory defaults

In addition to resetting the Com-Server to its factory defaults using the Telnet configuration (Port 1111), this can also be done via hardware. For this purpose all models have two adjacent jumpers on the board. For normal operation these jumpers must be out. To set the factory defaults, proceed as follows:

- Power off the Com-Server and open the enclosure
- Insert *both* jumpers and reconnect the supply voltage. An internal self-test will be performed during which messages will be issued on serial port A. The Fail message in the lines „Port A:“ and „TP Test:“ can be ignored.
- The self-test will be finished in approx. 20s, at which point the factory defaults are active.
- Turn off the Com-Server, open both jumpers and close up the housing again.



*Resetting the non-volatile memory results in a loss of all the settings which are different from the factory defaults, including the IP address. The setting profile of the factory defaults can be replaced by a customer-specific profile. In this cases the customer settings are activated after resetting.*

## Technical Data

### Com-Server Highspeed Industry 58631

<b>Supply voltage ...</b> ... DC ... AC	12V - 48V (+/-10%) 9Vrms - 30Vrms (+/-10%) AC adapter 18V/300mA included in scope of delivery
<b>Supply voltage UL version ...</b> ... DC	12V - 24V (+/-10%) DC adapter 12V/2A included in scope of delivery
<b>Current draw</b>	typ. 180mA @12VDC
<b>Permissible ambient temperatur ...</b> ... storage ... operating, non-cascaded ... operating, cascaded	-40 ... +70°C 0 ... +60°C 0 ... +50°C
<b>Permissible relative humidity</b>	0 - 95% (not condensing)
<b>Network</b>	10/100BaseT, RJ45 for STP cables
<b>Galvanic isolation</b>	min. 500Vrms
<b>Dimensions</b>	105 x 75 x 22mm
<b>Weight</b>	ca. 150g
<b>Serial ports</b>	1 x RS232/422/485 configurable, DB9/Male
<b>Baud rates</b>	50 to 230.400 kBit/s
<b>Data formats</b>	7, 8 data bit, 1, 2 stop bit, NO, EVEN, ODD parity
<b>Flow control</b>	Hardware-Handshake or Xon/Xoff protocol
<b>Fuse</b>	Littlefuse, Nano SMD Fuse,m Series 451, 1A/125V, Part no. 451 001

<sup>(1)</sup> When power is provided by a third-party power supply, it must meet the requirements for Limited Power Sources (LPS) in accordance with NEC Class 2.



## Com-Server Highspeed Isolated 58633

<b>Supply voltage ...</b>	
... DC	12V - 48V (+/-10%)
... AC	9Vrms - 30Vrms (+/-10%)
<b>Current draw</b>	typ. 130mA @24V
<b>Permissible ambient temperatur ...</b>	
... storage	-40 ... +70°C
... operating, non-cascaded	0 ... +60°C
... operating, cascaded	0 ... +50°C
<b>Permissible relative humidity</b>	0 - 95% (not condensing)
<b>Network</b>	10/100BaseT, RJ45 for STP cables
<b>Galvanic isolation</b>	Network: min. 500Vrms Serial ports: min. 1kV
<b>Dimensions</b>	105 x 75 x 45mm
<b>Weight</b>	ca. 190g
<b>Serial ports</b>	3 x RS232/422/485 configurable, DB9/Male
<b>Baud rates</b>	50 to 230.400 kBit/s
<b>Data formats</b>	7, 8 data bit, 1, 2 stop bit, NO, EVEN, ODD parity
<b>Flow control</b>	Hardware-Handshake or Xon/Xoff protocol

## Com-Server Highspeed PoE 58641

<b>Supply voltage ...</b>	37 - 57V from PSE
Power over Ethernet	
External supply...	
... DC	12V - 48V (+/-10%)
... AC	9Vrms - 30Vrms (+/-10%)
<b>Current draw</b>	typ. 130mA @24V PoE Class 1 (0,44 - 3,84W)
<b>Permissible ambient temperatur ...</b>	
... storage	-40 ... +70°C
... operating, non-cascaded	0 ... +60°C
... operating, cascaded	0 ... +50°C
<b>Permissible relative humidity</b>	0 - 95% (not condensing)
<b>Network</b>	10/100BaseT, RJ45 for STP cables
<b>Galvanic isolation</b>	Network: min. 500Vrms Serial ports: min. 1kV
<b>Dimensions</b>	105 x 75 x 22mm
<b>Weight</b>	ca. 150g
<b>Serial ports</b>	1 x RS232/422/485 configurable, DB9/Male
<b>Baud rates</b>	50 to 230.400 kBit/s
<b>Data formats</b>	7, 8 data bit, 1, 2 stop bit, NO, EVEN, ODD parity
<b>Flow control</b>	Hardware handshake or Xon/Xoff protocol

**Com-Server Highspeed 100BaseFX 58651**

<b>Supply voltage ...</b>	
... DC	12V - 48V (+/-10%)
... AC	18Vrms - 30Vrms (+/-10%)
<b>Current draw</b>	typ. 110mA @24V DC
<b>Permissible ambient temperatur ...</b>	
... storage	-40 ... +70°C
... operating, non-cascaded	0 ... +55°C
<b>Permissible relative humidity</b>	0 - 95% (non condensing)
<b>Network ...</b>	
... interface	100BaseFX HD/FD, ST connector
... FO medium	Duplex multimode cable 50/125µm and 62,5/125µm
... wavelength	1300nm
... distance	max. 2000m
... optical budget	7dB with 50/125µm 10 dB with 62,5/125µm
<b>Dimensions</b>	105 x 75 x 45mm
<b>Weight</b>	approx. 150g
<b>Serial ports</b>	1 x RS232/422/485 configurable, DB9/male (optional 20mA)
<b>Baud rates</b>	50 to 230.400 kBit/s
<b>Data formats</b>	7, 8 data bits, 1, 2 stop bit, NO, EVEN, ODD parity
<b>Flow control</b>	Hardware handshake or Xon/Xoff protocol

**Com-Server Highspeed Office 58031, 58034**

<b>Supply voltage</b>	100-250V /50-60Hz with cold-device cable
<b>Current draw</b>	approx. 3,5W
<b>Permissible ambient temperature ...</b>	
... storage	-20 ... +60°C
... operating	0 ... +50°C
<b>Permissible relative humidity</b>	0 - 95% (not condensing)
<b>Network</b>	10/100BaseT, RJ45 for STP cables
<b>Galvanic isolation</b>	min. 500V to Network
<b>Dimensions</b>	212x168x40mm
<b>Weight</b>	approx. 1000g
<b>Serial ports</b>	
... 58031	1 x RS232/422/485 configurable
... 58034	4 x RS232/422/485 configurable all DB9/Male
<b>Baud rates</b>	50 to 230.400 kBit/s
<b>Data formats</b>	7, 8 data bit, 1, 2 stop bit, NO, EVEN, ODD parity
<b>Flow control</b>	Hardware-Handshake or Xon/Xoff protocol

**Com-Server Highspeed 19" 58331, 58334**

<b>Supply voltage</b>	DC 5V +/-5%
<b>Current draw ...</b> 58331 58334	typ. 320mA @5V typ. 360mA @5V
<b>Permissible ambient temperature ...</b> ... Lagerung ... Betrieb	-40 ... +70°C 0 ... +60°C
<b>Permissible ambient humidity</b>	0 - 95% (not condensing)
<b>Network</b>	10/100BaseT, RJ45 for STP cables
<b>Galvanic isolation</b>	min. 500V to network
<b>Dimensions ...</b> Front panel 58331 Front panel 58334 Board 58331 & 58334	approx. 130x40mm (3HEx8TE) approx. 130x60mm (3HEx12TE) 160x100mm
<b>Weight ...</b> 58331 58334	approx. 180g approx. 240g
<b>Serial ports ...</b> 58331 58334	1 x RS232/422/485 configurable with DB9/male 4 x RS232/422/485 configurable with DB9/male
<b>Baud rates</b>	50 to 230.400 kBit/s
<b>Data formats</b>	7, 8 data bit, 1, 2 stop bit, NO, EVEN, ODD parity
<b>Flow control</b>	Hardware-Handshake or Xon/Xoff protocol

**Com-Server Highspeed OEM 58431**

<b>Supply voltage</b>	DC 5V +/-5%
<b>Current draw</b>	typ. 250mA, max. 325mA @5V
<b>Permissible ambient temperature ...</b>	
... storage	-40 ... +70°C
... operating	0 ... +60°C
<b>Permissible relative humidity</b>	0 - 95% (not condensing)
<b>Network</b>	10/100BaseT, RJ45 for STP cables
<b>Galvanic isolation</b>	min. 500Vrms
<b>Dimensions</b>	95,8 x 71,1 mm
<b>Weight</b>	ca. 200g
<b>Serial ports</b>	1 x TTL, 2mm 12-pin adapter (optional 10pol./RM 2,54mm)
<b>Baud rates</b>	50 to 230.400 kBit/s
<b>Data formats</b>	7, 8 Data bit, 1, 2 stop bit, NO, EVEN, ODD parity
<b>Flow control</b>	Hardware-Handshake or Xon/Xoff protocol

**Com-Server Highspeed Compact 58231**

<b>Supply voltage ...</b>	DC 5V +/-5%
<b>Current draw</b>	typ. 270mA, max. 345mA @5V
<b>Permissible ambient temperatur ...</b>	
... storage	-40 ... +70°C
... operating	0 ... +50°C
<b>Permissible relative humidity</b>	0 - 95% (not condensing)
<b>Network</b>	10/100BaseT, RJ45 for STP cables
<b>Galvanic isolation</b>	min. 500Vrms to network
<b>Dimensions</b>	115 x 90 x 34mm
<b>Weight</b>	approx. 300g
<b>Serial ports</b>	1 x RS232/422/485 configurable, DB9/Male
<b>Baud rates</b>	50 to 230.400 kBit/s
<b>Data formats</b>	7, 8 data bit, 1, 2 stop bit, NO, EVEN, ODD parity
<b>Flow control</b>	Hardware-Handshake or Xon/Xoff protocol

**Index****Symbole**

2-wire bus 58  
 20mA interface 62  
 4-wire bus 58

**A**

A&E 180  
 APPE 148  
 ASCII 145  
 Auto Negotiation 51

**B**

Baud Divisor 96  
 Baud rate 96  
 baud rate 191  
 BOOTP 21, 86  
 Box-to-Box 140  
 BOX\_CNTRL 191

**C**

Cable type 83  
 Clear Port Mode 184, 190  
 COM\_ERROR 188  
 COM\_STAT 189  
 configuration up-/download 197  
 connection status 182  
 Connection Timeout 115  
 control port 186  
 control structure 187  
 CTS 97, 99

**D**

DA 3.0 180  
 Data bits 96  
 data bits 191  
 data format 67  
 DHCP 21, 24  
 DHCP Client 85  
 Disconnect Char 115, 158  
 DNS 85  
 DNS Server 85  
 DNS status 182  
 DNS-Server 85  
 DSR 97, 99  
 DTR 97, 99, 193

**E**

Easyterm 216  
 Error State 183  
 Error-LED 67

**F**

Factory Default 12  
 Factory Defaults 90  
 factory defaults 223  
 FIFO 101  
 Firmware update 89  
 firmware update 205  
 fixed routes 84  
 flashing patterns 67  
 Flow Control 99  
 Flush Buffer 93  
 Framing Error 184  
 framing error 67  
 FTP Client Login 148  
 Full Duplex 51, 53

**G**

Gateway 84, 217  
 GET 144

**H**

Half Duplex 51, 53  
 Handshake 67, 98  
 handshake lines 189  
 Handshake special 98  
 Hardware Handshake 97  
 Hyperterminal 218

**I**

IMAGE 145  
 Inactivity Timeout 149, 158  
 Inventory 199  
 IP address 13, 84, 216  
 IP Bus mode 162

**K**

keep-alive 87  
 keep-alive check 86

**L**

Lease-Time 26  
 LIST 148

**M**

MAC address 18, 83  
 Master port 139  
 Master-Slave bus 161  
 MIB / SNMP 202  
 MTU 85



**N**

Network Delay 92  
 No halt on XOFF/RTS/DTR 183  
 NO Handshake 98

**O**

OPC 173  
 OPC client 176  
 OPC server 175  
 OPC variables 180  
 OPC-Server 175  
 Overrun Error 183

**P**

parity 96, 191  
 Parity Error 184  
 parity error 67  
 Password 87, 88  
 Pin assignment 56, 62  
 PoE 42  
 Port State 182  
 Power over Ethernet 42  
 PUT 144

**Q**

QUIT 145

**R**

RARP 21, 30  
 Receive-Filter 101  
 Reset 194, 196  
 Reset-Pin 60, 64  
 RETR 148  
 Retransmission Timeout 87  
 Routing 84  
 RS232 54  
 RTS 97, 99, 193  
 Run Time 83

**S**

Send-Filter 100  
 Serial assignment of the IP 216  
 Serial Socket Interface 172  
 Show Connection 99  
 Slave IP address 139  
 Slave Port 139  
 SLIP-Net Routing 166  
 SNMP 88, 202  
 SOFTW Date/Rev. 83  
 Software Handshake 98  
 Status-LED 67  
 stop bits 96, 191  
 STOR 148  
 Subnet Mask 84, 217  
 subnet mask 20

supply voltage 40  
 System Name 25, 89  
 System Options 92  
 System Password 88

**T**

Technical Data 224  
 Telnet Echo 93  
 Telnet Password 87  
 Terminating 58  
 TYPE A 148  
 TYPE I 148

**U**

UDP 106  
 UDP port number 125

**W**

WuTility 14, 222

**X**

XON/XOFF 100  
 XON/XOFF (Filter) 100