

Manual

Industry Interfaces

W&T

Release
Type

1.6
11201, 41201
61201, 64201
66201, 80201
81201, 84201
86201, 86203
88205

© 06/2007 by Wiesemann & Theis GmbH

Subject to errors and changes:

Since we can make mistakes, none of our statements should be used without checking. Please let us know of any mistakes or misunderstandings you are aware of, so that we can recognize and eliminate them quickly.

Perform work on and with W&T products only as described here and only if you have read and understood the manual fully. Unauthorized use can result in hazards. We are not liable for the consequences of unauthorized use. When in doubt, check with us or consult your dealer!

Wiesemann & Theis offers with their Industry Interfaces a complete family of interface converters suitable for top hat rail mounting and powered by the 24V supply commonly used in industrial environments.

Trouble-free, noise-immune operation of the associated components is ensured by integrated galvanic isolation between the two interfaces used as well as between the power supply and the interfaces.

This interface family is described on the following pages along with the corresponding technical data and including connection examples.

For up-to-date information on new developments, see our Internet site at <http://www.wut.de> or check the e-mail short notices at the W&T Interface Club, which you can also subscribe to from the W&T Homepage.

Index

RS232 <> 20mA Interface, #84201 59

RS232 <> RS422/RS485 Interface, #86201 & 86203 63

20mA <> RS422/RS485 Interface, #64201 69

RS232 Isolator, #88205 75

RS422/RS485 Isolator, #66201 79

RS232 <> POF Interface , #81201 85

RS422/RS485 <> POF Interface, #61201 89

20mA <> POF Interface, #41201 95

POF Repeater, #11201 101

RS232 Line Driver Set, #80201 105

RS232 <> 20mA Interface, #84201

The W&T Interface Model 84201 permits bi-directional connection of RS232 devices with components, which are equipped with an 20mA port.

Function

The interface converts one data line in each direction and provides electrical isolation between the RS232 side and the 20mA side. The interface is build in a small plastic housing designed for top hat rail mounting according to DIN EN 50022-35.

Power supply

The interface uses a build-in switching regulator for power supply and has a wide input voltage range from 12V to 24V. The operating voltage can be supplied by the enclosed AC adaptor or by any other AC or DC voltage in the permissible range. The interface has a build-in reverse voltage protection. The power can be supplied by screwed contacts.

Isolation and ESD protection

Both ports of the device are isolated from each other and from the power supply with a dielectric strength of 1000 volts. The signals are isolated by means of high-speed opto-couplers; energy is supplied to the driver and receiver elements by means of an isolated DC/DC converter. All signal lines are protected against electrostatic discharge of up to 15kV according to IEC 801-2, level 4.

Connectors

The two ports of the interface use DB9 male connectors. The connector pin assignments are shown in the table below:

RS232 interface:

Pin#	Function
2	data in
3	data out
4	active level
5	signal GND
7	active level

20mA interface:

Pin#	Function
1	data out 20mA
2	data out +
3	data out -
4	data out GND
5	n.c.
6	data in 20mA
7	data in +
8	data in -
9	data in GND

Display elements

The interface includes two LEDs, with green for indicating the correct supply voltage and red for verifying data transmission in both directions.

Applications

The interface can be used as an active or passive 20mA component. In the active mode the interface supplies the current required by the respective 20mA loop, while in the passive mode the loop current must be supplied by the connected device. The operating mode can be selected for both loops separately. Examples of interface switching into active/passive mode are shown on the following drawings:

Interface Tx and Rx loop active

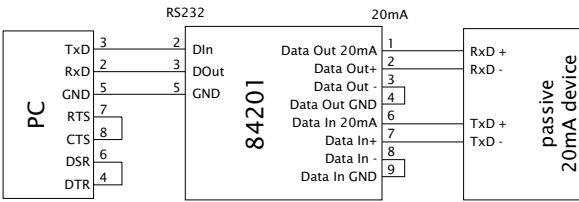

Interface Tx and Rx loop passive

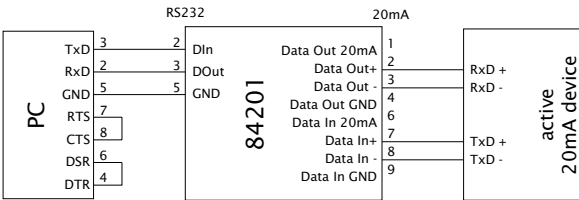

Interface Tx loop active, interface Rx loop passive

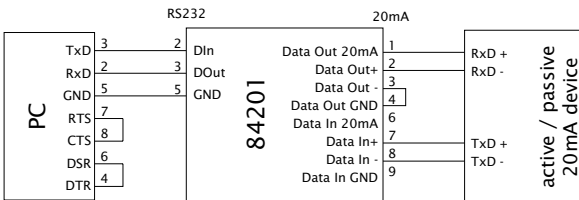

Technical Data

Baud rate:	0..19,200 baud
Data format:	any format
Supported signals:	RxD, TxD
Operating modes:	active or passive mode
Electrical isolation:	both ports from each other and from power supply with a dielectric strength of 1000 volts
ESD immunity:	up to 15kV corresponding to IEC 801-2, Level 4
Power supply:	supplied power adapter or 12..24V DC/AC
Current consumption:	approx. 175mA @12V DC
RS232 adapter:	9-pin male SUB-D adapter
20mA adapter:	9-pin male SUB-D adapter
Ambient temperature:	storage: -40..+70°C operation: 0..+60°C at external 24V supply voltage
Housing / Dimensions:	small plastic housing for top hat rail mounting, 105x75x22mm
Weight:	approx. 600g incl. power adapter
Delivery:	RS232 <> 20mA Interface power adapter for application in office

RS232 <> RS422/RS485 Interfaces, #86201 & 86203

The W&T Interface Model 86201 and Model 86203 permit bi-directional connection of RS232 devices with components, which are equipped with an RS422 or RS485 port.

Function

The interfaces convert one data line and one handshaking line in each direction and provide electrical isolation between the RS232 side and the RS422/RS485 side. The interfaces are build in a small plastic housing designed for top hat rail mounting according to DIN EN 50022-35.

Power supply

Both interfaces use a build-in switching regulator for power supply and have a wide input voltage range from 12V to 24V. The operating voltage can be supplied by the enclosed AC adaptor or by any other AC or DC voltage in the permissible range. The interfaces have a build-in reverse voltage protection. The power can be supplied by screwed contacts.

Isolation and ESD protection

Both ports of the devices are isolated from each other and from the power supply with a dielectric strength of 1000 volts. The signals are isolated by means of high-speed opto-couplers; energy is supplied to the driver and receiver elements by means of an isolated DC/DC converter. All signal lines are protected against electrostatic discharge of up to 15kV according to IEC 801-2, level 4.

Overvoltage protection (Model 86203 only)

The maximum differential voltage allowed to reach the RS485 transceiver chip of the interfaces from the outside is around $\pm 12 \dots 14V$ according to the data sheets. Voltage exceeding this amount will inevitably result in destruction of the line drivers.

Interface model 86203 has integrated overvoltage protection which uses suppressor diodes to limit the maximum voltage to approx. $\pm 9V$.

This overvoltage protection is limited of course by the capacity of the protection diodes used, which can let through a current of 20A for a short time. This means it may not be a substitute for a lightning surge arrestor for long cables in exposed locations (e.g. in the mountains).

Connectors

The two ports of the interfaces use DB9 male connectors. The connector pin assignments are shown in the table below:

RS232 interface:

Pin#	Function
2	data in
3	data out
4	handshake out
5	signal GND
8	handshake in

RS422/RS485 interface:

Pin#	Function
1	data out A (-)
2	data in A (-)
3	handshake out A (-)
4	handshake in A (-)
5	signal GND
6	data out B (+)
7	data in B (+)
8	handshake out B (+)
9	handshake in B (+)

Display elements

The interfaces include two LEDs, with green for indicating the correct supply voltage and red for verifying data transmission in both directions.

Operating mode

The interfaces can be set for five operating modes by DIP switch setting on the RS422/RS485 interface module. The selectable operating modes are briefly described here:

RS422, RS485 4-wire bus master application

One data channel and one handshake channel in each direction are available. The RS422/RS485 receivers and transmitters are always active in this operating mode.

RS485 4-wire / 2-wire application with echo, handshake control

One data channel in each direction is available. The RS485 output driver is activated with a positive RS232 handshake in signal, while a negative signal forces the driver to high impedance state. The RS485 receiving channel is always active in this operating mode.

RS485, 2-wire application without echo, handshake control

One data channel in each direction is available. The RS485 output driver is activated with a positive RS232 handshake in signal, while a negative signal forces the driver to high impedance state. The RS485 receiving channel is deactivated when the driver is on, but is switched on when the driver is in the high impedance state.

RS485, 4 wire application / RS485 2-wire application with echo, automatic control

One data channel in each direction is available. The RS485 output driver is activated automatically with each transmission of data, and goes to the high impedance state again after the end of transmission. The RS485 receiving channel is always active in this operating mode.

RS485, 2 wire application without echo, automatic control

One data channel in each direction is available. The RS485 output driver is activated automatically with each transmission of data, and goes to the high impedance state again after the end of transmission.

The RS485 receiving channel is deactivated when the driver is on, but is switched on when the driver is in the high impedance state

Setting the operating modes

To configure the RS485 / RS422 Interfaces, the enclosure must be opened to set the mode type/termination DIP switches on the interface module. For this purpose we recommend threading a SUB-D connector with connector body onto the Interface and use the threaded-on connector to assist in removing the housing cover from the housing body.

Please see the following table for an explanation of the operating mode DIP switch:

Operating mode	SW1	SW2	SW3	SW4	SW5	SW8
RS422, RS485, 4-wire bus master	OFF	OFF	OFF	ON	OFF	OFF
RS485, 4-wire / 2-wire with echo, handshake control	OFF	OFF	ON	ON	OFF	OFF
RS485, 4-wire / 2-wire without echo, handshake control	ON	OFF	ON	ON	OFF	OFF
RS485, 4-wire / 2-wire with echo, automatic control	OFF	ON	OFF	ON	OFF	OFF
RS485, 4-wire / 2-wire without echo, automatic control	ON	ON	OFF	ON	OFF	OFF

Termination

For all RS485 operating modes it is essential that the bus system be terminated with a termination network which assures a defined rest state in the high-impedance phases of bus operation. The bus system can be connected to a termination network by closing switches #6 and #7 on the interface module.

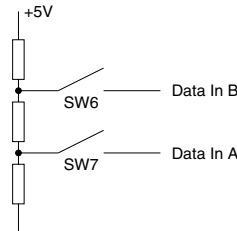

Applications

RS422 hardware handshake application

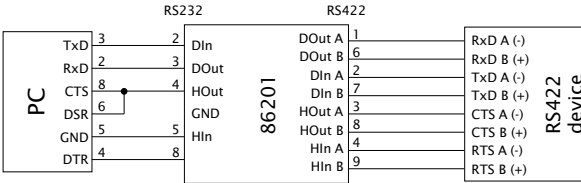

RS485 4-wire bus master application

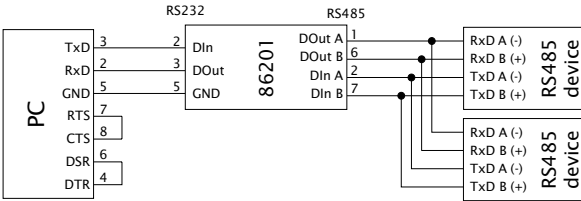

RS485 2-wire application with handshake control

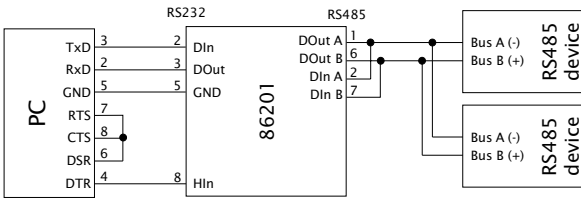

RS485 2-wire application with automatic control

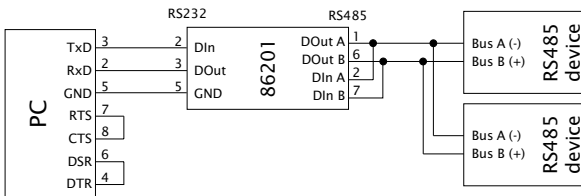

Technical Data

Operating modes:	RS422 RS485 2/4 wire mode with handshake control RS485 2/4 wire mode with automatic control
Switchover delay:	approx. 10 μ s from send to receive for RS485 automatic control (can be factory changed on request)
Baud rate:	0..115,200 baud
Data format:	any format
Supported signals:	RxD, TxD, CTS, DTR
Termination:	Switchable termination network for RS485 operation
Electrical isolation:	both ports from each other and from power supply with a dielectric strength of 1000 volts
Overvoltage protection:	Model 86203 only: limiting of differential voltage by suppressor diodes to $V_{max} = 9,2V$ ($I_{max} = 20A$, $t = 10ms$)
ESD immunity:	up to 15kV corresponding to IEC 801-2, Level 4
Power supply:	supplied power adapter or 12..24V DC/AC
Current consumption:	approx. 150mA @12V DC
RS232 adapter:	9-pin male SUB-D adapter
RS422/RS485 adapter:	9-pin male SUB-D adapter
Ambient temperature:	storage: -40..+70°C operation: 0..+60°C at external 24V supply voltage
Housing / Dimensions:	small plastic housing for top hat rail mounting, 105x75x22mm
Weight:	approx. 600g incl. power adapter
Delivery:	RS232 <-> RS422/RS485 Interface power adapter for application in office

20mA ↔ RS422/RS485 Interface, #64201

The W&T Interface Model 64201 permits bi-directional connection of 20mA devices with components, which are equipped with an RS422 or RS485 port.

Function

The interface converts one data line in each direction and provides electrical isolation between the 20mA side and the RS422/RS485 side. The interface is build in a small plastic housing designed for top hat rail mounting according to DIN EN 50022-35.

Power supply

The interface uses a build-in switching regulator for power supply and has a wide input voltage range from 12V to 24V. The operating voltage can be supplied by the enclosed AC adaptor or by any other AC or DC voltage in the permissible range. The interface has a build-in reverse voltage protection. The power can be supplied by screwed contacts.

Isolation and ESD protection

Both ports of the device are isolated from each other and from the power supply with a dielectric strength of 1000 volts. The signals are isolated by means of high-speed opto-couplers; energy is supplied to the driver and receiver elements by means of an isolated DC/DC converter. All signal lines are protected against electrostatic discharge of up to 15kV according to IEC 801-2, level 4.

Connectors

The two ports of the interface use DB9 male connectors. The connector pin assignments are shown in the table below:

RS422/RS485 interface:

Pin#	Function
1	data out A (-)
2	data in A (-)
5	signal GND
6	data out B (+)
7	data in B (+)

20mA interface:

Pin#	Function
1	data out 20mA
2	data out +
3	data out -
4	data out GND
5	n.c.
6	data in 20mA
7	data in +
8	data in -
9	data in GND

Display elements

The interface includes two LEDs, with green for indicating the correct supply voltage and red for verifying data transmission in both directions.

Operating modes

20mA interface

The interface can be used as an active or passive 20mA component. In the active mode, the interface supplies the current required by the respective 20mA loop, while in the passive mode the loop current must be supplied by the connected device. The operating mode can be selected for both loops separately.

RS422/RS485 interface

The interface can be set for three operating modes by DIP switch setting on the RS422/RS485 interface module. The selectable operating modes are briefly described here:

RS422, RS485 4-wire bus master application

One data channel and one handshake channel in each direction are available. The RS422/RS485 receivers and transmitters are always active in this operating mode.

RS485 4-wire bus systems

One data channel in each direction is available. The RS485 output driver is activated automatically with each transmission of data, and goes to the high impedance state again after the end of transmission. The RS485 receiving channel is always active in this operating mode.

RS485 2-wire bus systems

One data channel in each direction is available. The RS485 output driver is activated automatically with each transmission of data, and goes to the high impedance state again after the end of transmission. The RS485 receiving channel is deactivated when the driver is on, but is switched on when the driver is in the high impedance state.

Setting the operating modes

To configure the RS485 / RS422 Interfaces, the enclosure must be opened to set the mode type/termination DIL switches on the interface module. For this purpose we recommend threading a SUB-D connector with connector body onto the Interface and use the threaded-on connector to assist in removing the housing cover from the housing body.

Please see the following table for an explanation of the operating mode DIP switch:

Betriebsart	SW1	SW2	SW3	SW4	SW5	SW8
RS422, RS485, 4-Draht-Bus-Master	OFF	OFF	OFF	ON	OFF	OFF
RS485, 4-Draht-Bussysteme	OFF	ON	OFF	ON	OFF	OFF
RS485, 2-Draht-Bussysteme	ON	ON	OFF	ON	OFF	OFF

Termination

For all RS485 operating modes it is essential that the bus system be terminated with a termination network which assures a defined rest state in the high-impedance phases of bus operation.

The bus system can be connected to a termination network by closing switches #6 and #7 on the interface module:

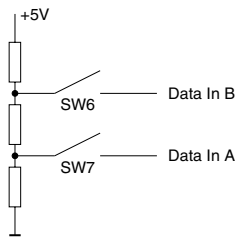

Applications

Interface Tx and Rx loop active

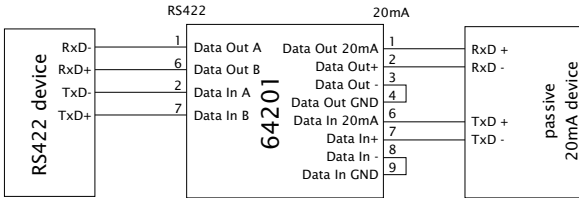

Interface Tx and Rx loop passive

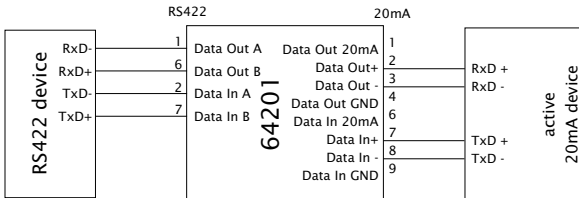

Interface Tx loop active, interface Rx loop passive

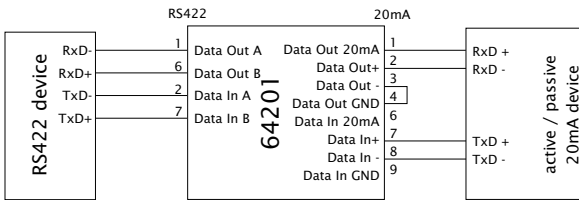

RS485 <-> 20mA, interface Tx loop active, interface Rx loop passive

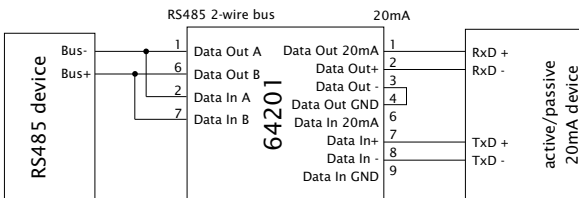

Technical Data

Operating modes:	RS422 RS485 2/4 wire mode with automatic control 20mA: active or passive mode
Switchover delay:	approx. 10µs from send to receive for RS485 automatic control (can be factory changed on request)
Baud rate:	0..19,200 baud
Data format:	any format
Supported signals:	RxD, TxD
Termination:	Switchable termination network for RS485 operation
Electrical isolation:	both ports from each other and from power supply with a dielectric strength of 1000 volts
ESD immunity:	up to 15kV corresponding to IEC 801-2, Level 4
Power supply:	supplied power adapter or 12..24V DC/AC
Current consumption:	approx. 140mA @12V DC
20mA adapter:	9-pin male SUB-D adapter
RS422/RS485 adapter:	9-pin male SUB-D adapter
Ambient temperature:	storage: -40..+70°C operation: 0..+60°C at external 24V supply voltage
Housing / Dimensions:	small plastic housing for top hat rail mounting, 105x75x22mm
Weight:	approx. 600g incl. power adapter
Delivery:	20mA <> RS422/RS485 Interface power adapter for application in office

RS232 Isolator, #88205

The W&T RS232 Isolator Model 88205 permits bi-directional connection of two RS232 devices with an electrical isolation voltage of 1000 Volts.

Function

The isolator supports all data and handshaking lines of 9 pin RS232 interfaces and has two mutually independent, active RS232 interfaces. Therefore the isolator can be used as a RS232 repeater device to double the permissible cable length by inserting the isolator in the middle of the transmission line. The RS232 isolator is build in a small plastic housing designed for top hat rail mounting according to DIN EN 50022-35.

Power supply

The isolator uses a build-in switching regulator for power supply and has a wide input voltage range from 12V to 24V. The operating voltage can be supplied by the enclosed AC adaptor or by any other AC or DC voltage in the permissible range. The interface has a build-in reverse voltage protection. The power can be supplied by screwed contacts.

Isolation and ESD protection

Both ports of the device are isolated from each other and from the power supply with a dielectric strength of 1000 volts. The signals are isolated by means of high-speed opto-couplers; energy is supplied to the driver and receiver elements by means of an isolated DC/DC converter. All signal lines are protected against electrostatic discharge of up to 15kV according to IEC 801-2, level 4.

Connectors

The DTE port of the isolator uses a 9-pin male SUB-D connector, while the DCE port uses an 9-pin female SUB-D connector. The connector pin assignments are shown in the table below:

RS232 DCE interface (9-pin female)

Pin#	Function	Direction
1	DCD	output
2	RxD	output
3	TxD	input
4	DTR	input
5	GND	GND
6	DSR	output
7	RTS	input
8	CTS	output
9	RI	output

RS232 DTE interface (9-pin male)

Pin#	Function	Direction
1	DCD	input
2	RxD	input
3	TxD	output
4	DTR	output
5	GND	GND
6	DSR	input
7	RTS	output
8	CTS	input
9	RI	input

Display elements

The isolator includes two LEDs, with green for indicating the correct supply voltage and red for verifying data transmission in both directions.

Applications

hardware handshake controlled PC <-> modem communication

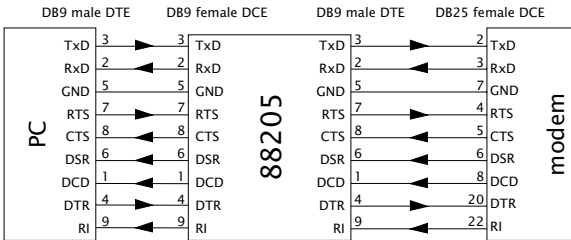

software handshake controlled PC <-> PC communication

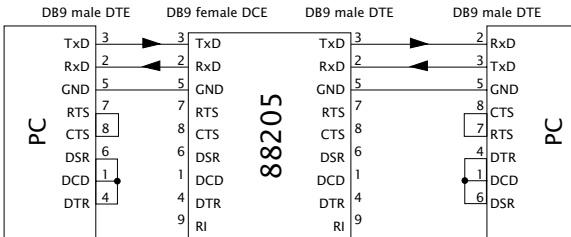

Technical Data

Baud rate:	0..115,200 baud
Data format:	any format
Supported signals:	RxD, TxD, RTS, CTS, DSR, DCD, DTR, RI
Electrical isolation:	both ports from each other and from power supply with a dielectric strength of 1000 volts
ESD immunity:	up to 15kV corresponding to IEC 801-2, Level 4
Power supply:	supplied power adapter or 12..24V DC/AC
Current consumption:	approx. 150mA @12V DC
RS232 DTE adapter:	9-pin male SUB-D adapter
RS232 DCE adapter:	9-pin female SUB-D adapter
Ambient temperature:	storage: -40..+70°C operation: 0..+60°C at external 24V supply voltage
Housing / Dimensions:	small plastic housing for top hat rail mounting, 105x75x22mm
Weight:	approx. 600g incl. power adapter
Delivery:	RS232 Isolator power adapter for application in office

RS422 / RS485 Isolator, #66201

The W&T RS422/RS485 Isolator Model 66201 permits bi-directional connection of two RS422 devices or RS485 bus systems with an electrical isolation voltage of 1000 Volts.

Function

In RS422 mode the isolator supports one data and one handshaking line in each direction. In RS485 mode the isolator supports 2-wire and 4-wire bus systems. The repeater is build in a small plastic housing designed for top hat rail mounting according to DIN EN 50022-35.

Power supply

The isolator uses a build-in switching regulator for power supply and has a wide input voltage range from 12V to 24V. The operating voltage can be supplied by the enclosed AC adaptor or by any other AC or DC voltage in the permissible range. The interface has a build-in reverse voltage protection. The power can be supplied by screwed contacts.

Isolation and ESD protection

Both ports of the device are isolated from each other and from the power supply with a dielectric strength of 1000 volts. The signals are isolated by means of high-speed opto-couplers; energy is supplied to the driver and receiver elements by means of an isolated DC/DC converter. All signal lines are protected against electrostatic discharge of up to 15kV according to IEC 801-2, level 4.

Connectors

The two ports of the device use DB9 male connectors. The connector pin assignments are shown in the table below:

Pin#	Function
1	data out A (-)
2	data in A (-)
3	handshake out A (-)
4	handshake in A (-)
5	signal GND
6	data out B (+)
7	data in B (+)
8	handshake out B (+)
9	handshake in B (+)

Display elements

The isolator includes two LEDs, with green for indicating the correct supply voltage and red for verifying data transmission in both directions.

Operating mode

The isolator can be set for three operating modes by DIP switch setting on the RS422/RS485 interface module. The selectable operating modes are briefly described here:

RS422

One data channel and one handshake channel in each direction are available. The RS422/RS485 receivers and transmitters are always active in this operating mode.

RS485 4-wire bus systems

One data channel in each direction is available. The RS485 output driver is activated automatically with each transmission of data, and goes to the high impedance state again after the end of transmission. The RS485 receiving channel is always active in this operating mode.

RS485 2-wire bus systems

One data channel in each direction is available. The RS485 output driver is activated automatically with each transmission of data, and goes to the high impedance state again after the end of transmission. The RS485 receiving channel is deactivated when the driver is on, but is switched on when the driver is in the high impedance state.

Setting the operating modes

To configure the RS485 / RS422 Interfaces, the enclosure must be opened to set the mode type/termination DIL switches on the interface module. For this purpose we recommend threading a SUB-D connector with connector body onto the Interface and use the threaded-on connector to assist in removing the housing cover from the housing body.

Please see the following table for an explanation of the operating mode DIP switch:

Operating mode	SW1	SW2	SW3	SW4	SW5	SW8
RS422	OFF	OFF	OFF	ON	OFF	OFF
RS485, 4-wire bus system	OFF	ON	OFF	ON	OFF	OFF
RS485, 2-wire bus system	ON	ON	OFF	ON	OFF	OFF

Termination

For all RS485 operating modes it is essential that the bus system be terminated with a termination network which assures a defined rest state in the high-impedance phases of bus operation.

The bus system can be connected to a termination network by closing switches #6 and #7 on the interface module:

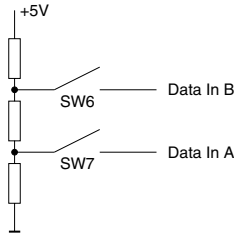

Applications

RS422 hardware handshake application

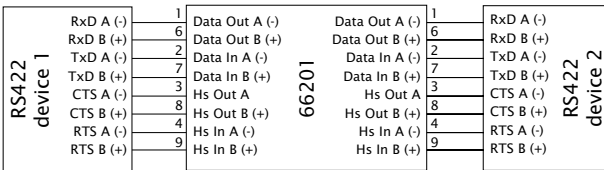

RS485 2-wire application

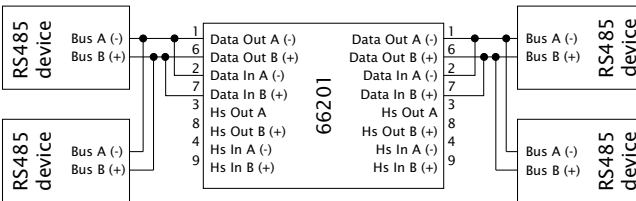

Technical Data

Operating modes:	RS422 RS485 2/4 wire mode with automatic control
Switchover delay:	approx. 10 μ s from send to receive for RS485 automatic control (can be factory changed on request)
Baud rate:	0..3 Mbaud
Data format:	any format
Supported signals:	RxD, TxD, CTS, DTR
Termination:	Switchable termination network for RS485 operation
Electrical isolation:	both ports from each other and from power supply with a dielectric strength of 1000 volts
ESD immunity:	up to 15kV corresponding to IEC 801-2, Level 4
Power supply:	supplied power adapter or 12..24V DC/AC
Current consumption:	approx. 140mA @12V DC
RS422/RS485 adapter:	9-pin male SUB-D adapter
Ambient temperature:	storage: -40..+70°C operation: 0..+60°C at external 24V supply voltage
Housing / Dimensions:	small plastic housing for top hat rail mounting, 105x75x22mm
Weight:	approx. 600g incl. power adapter
Delivery:	RS422/RS485 Isolator power adapter for application in office

RS232 <> POF Interface, #81201

The W&T Interface Model 81201 permits bi-directional connection of RS232 devices with components, which are equipped with plastic fiber optics interface.

Function

The Interface supports one data line in each direction and transmits data over a distance of max. 100 meters. The transmission medium is standard duplex plastic fiber optic cable, which is inexpensive and extremely easy to work with and install. The use of fiber optics as a transmission medium ensures perfect galvanic isolation between the connected devices and clean transmission even in noise-prone environments. The interface is build in a small plastic housing designed for top hat rail mounting according to DIN EN 50022-35.

Power supply

The interface uses a build-in switching regulator for power supply and has a wide input voltage range from 12V to 24V. The operating voltage can be supplied by the enclosed AC adaptor or by any other AC or DC voltage in the permissible range. The interface has a build-in reverse voltage protection. The power can be supplied by screwed contacts.

Isolation and ESD protection

The RS232 port of the device is isolated from the power supply with a dielectric strength of 1000 volts. The signals are isolated by means of high-speed opto-couplers; energy is supplied to the driver and receiver elements by means of an isolated DC/DC converter. All signal lines are protected against electrostatic discharge of up to 15kV according to IEC 801-2, level 4.

Connections

The fiber optic connection for the interface is configured as a self-locking coupling for duplex plastic fiber optics, with the RS232 interface formatted as DB9 male connector. Refer to the following table for connector pin assignments:

Pin#	Function
2	data in
3	data out
4	active level
5	signal GND
7	active level

Display elements

The interface includes two LEDs, with green for indicating the correct supply voltage and red for verifying data transmission in both directions.

Assembly

Connecting the plastic fiber optic cable to the interface requires no special tools:

- Trim the fiber optic cable to the desired length using a sharp knife. Make your cut as close to a right angle to the longitudinal axis of the cable as possible. A simple cut is generally sufficient, with no reworking required.
- Separate the individual duplex conductors back from the cut point to a distance of around 2cm.
- Pull the locking levers on the fiber optic female connector back towards the module along the upper side of the coupling.

- At the same time insert the separated end of the fiber optic duplex line into the fiber optic coupling female.
- Releasing the locking levers locks the fiber optics into the coupling.
- To release, pull the two locking levers on the top of the coupling towards the module, and pull the fiber optic cable out of the female.

The arrows on the top side of the coupling clearly show the location of the emitter and receiver lines.

Please note that when connecting two fiber optic components, the emitter of the first must always be connected to the receiver channel of the second component. A visible red light beam is always sent along with data, so that the sending line can always be easily identified.

Applications

**RS232 <> POF application
without hardware handshake**

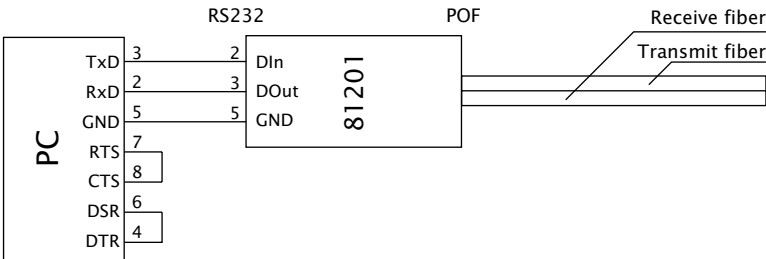

Technical Data

Baud rate:	0..115,200 baud
Data format:	any format
Supported signals:	RxD, TxD
Max. distance:	100m
Electrical Isolation:	Serial port from power supply with a dielectric strength of 1000 volts
ESD immunity:	up to 15kV corresponding to IEC 801-2, Level 4
Power supply:	supplied power adapter or 12..24V DC/AC
Current consumption:	approx. 130mA @12V DC
RS232 adapter:	9-pin male SUB-D adapter
POF adapter:	Integrated socket with automatic interlocking of the fiber-optic cable
POF medium:	Duplex plastic optical fiber cable 2.2 x 4.4 mm, fiber diameter of 980µm, core: PMMA, cladding: PE
Ambient temperature:	storage: -40..+70°C operation: 0..+50°C at external 24V supply voltage
Housing / Dimensions:	small plastic housing for top hat rail mounting, 105x75x22mm
Weight:	approx. 600g incl. power adapter
Delivery:	RS232 <> POF Interface power adapter for application in office

RS422/RS485 <> POF Interface, #61201

The W&T Interface Model 61201 permits bi-directional connection of RS422 and RS485 devices with components, which are equipped with a plastic fiber optics interface.

Function

The Interface supports one data line in each direction and transmits data over a distance of max. 100 meters. The transmission medium is standard duplex plastic fiber optic cable, which is inexpensive and extremely easy to work with and install. The use of fiber optics as a transmission medium ensures perfect galvanic isolation between the connected devices and clean transmission even in noise-prone environments. The interface is build in a small plastic housing designed for top hat rail mounting according to DIN EN 50022-35.

Power supply

The interface uses a build-in switching regulator for power supply and has a wide input voltage range from 12V to 24V. The operating voltage can be supplied by the enclosed AC adaptor or by any other AC or DC voltage in the permissible range. The interface has a build-in reverse voltage protection. The power can be supplied by screwed contacts.

Isolation and ESD protection

The RS422/RS485 port of the device is isolated from the power supply with a dielectric strength of 1000 volts. The signals are isolated by means of high-speed opto-couplers; energy is supplied to the driver and receiver elements by means of an isolated DC/DC converter. All signal lines are protected against electrostatic discharge of up to 15kV according to IEC 801-2, level 4.

Connections

The fiber optic connection for the interface is configured as a self-locking coupling for duplex plastic fiber optics, with the RS422/RS485 interface formatted as DB9 male connector. Refer to the following table for connector pin assignments:

Pin#	Function
1	data out A (-)
2	data in A (-)
5	signal GND
6	data out B (+)
7	data in B (+)

Display elements

The interface includes two LEDs, with green for indicating the correct supply voltage and red for verifying data transmission in both directions.

Assembly

Connecting the plastic fiber optic cable to the interface requires no special tools:

- Trim the fiber optic cable to the desired length using a sharp knife. Make your cut as close to a right angle to the longitudinal axis of the cable as possible. A simple cut is generally sufficient, with no reworking required.
- Separate the individual duplex conductors back from the cut point to a distance of around 2cm.

- Pull the locking levers on the fiber optic female connector back towards the module along the upper side of the coupling.
- At the same time insert the separated end of the fiber optic duplex line into the fiber optic coupling female.
- Releasing the locking levers locks the fiber optics into the coupling.
- To release, pull the two locking levers on the top of the coupling towards the module, and pull the fiber optic cable out of the female.

The arrows on the top side of the coupling clearly show the location of the emitter and receiver lines.

Please note that when connecting two fiber optic components, the emitter of the first must always be connected to the receiver channel of the second component. A visible red light beam is always sent along with data, so that the sending line can always be easily identified.

Operating Mode

The interface can be set for three operating modes by DIP switch setting on the RS422/RS485 interface module. The selectable operating modes are briefly described here:

RS422, RS485 4-wire bus master application

One data channel and one handshake channel in each direction are available. The RS422/RS485 receivers and transmitters are always active in this operating mode.

RS485, 4 wire / 2-wire application with echo, automatic control

One data channel in each direction is available. The RS485 output driver is activated automatically with each transmission of data, and goes to the high impedance state again after the end of transmission. The RS485 receiving channel is always active in this operating mode.

RS485, 2 wire application without echo, automatic control

One data channel in each direction is available. The RS485 output driver is activated automatically with each transmission of data, and goes to the high impedance state again after the end of transmission. The RS485 receiving channel is deactivated when the driver is on, but is switched on when the driver is in the high impedance state.

Setting the operating modes

To configure the RS485 / RS422 Interfaces, the enclosure must be opened to set the mode type/termination DIL switches on the interface module. For this purpose we recommend threading a SUB-D connector with connector body onto the Interface and use the threaded-on connector to assist in removing the housing cover from the housing body.

Please see the following table for an explanation of the operating mode DIP switch:

Operating mode	SW1	SW2	SW3	SW4	SW5	SW8
RS422, RS485, 4-wire bus master	OFF	OFF	OFF	ON	OFF	OFF
RS485, 4-wire / 2-wire with echo	OFF	ON	OFF	ON	OFF	OFF
RS485, 2-wire bus systems w/o echo	ON	ON	OFF	ON	OFF	OFF

Termination

For all RS485 operating modes it is essential that the bus system be terminated with a termination network which assures a defined rest state in the high-impedance phases of bus operation. The bus system can be connected to a termination network by closing switches #6 and #7 on the interface module:

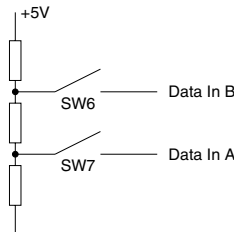

Applications

RS422 <> POF application

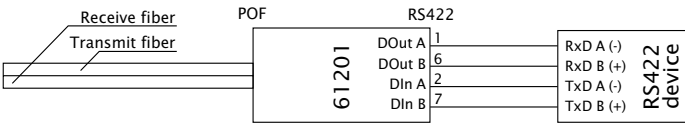

RS485 4-wire bus master <-> POF application

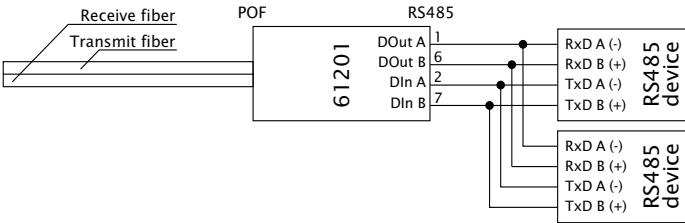

RS485 2-wire <-> POF application

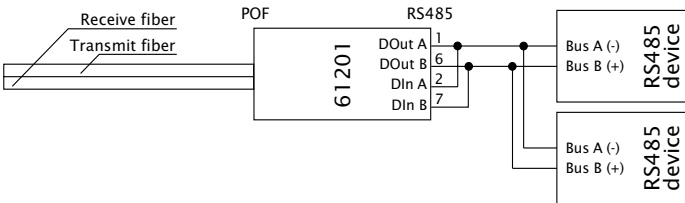

Technical Data

Operating modes:	RS422 RS485 2/4 wire mode with automatic control
Switchover delay:	approx. 10µs from send to receive for RS485 automatic control (can be factory changed on request)
Baud rate:	0..115,200 baud
Data format:	any format
Supported signals:	RxD, TxD
Max. distance:	100m
Electrical Isolation:	Serial port from power supply with a dielectric strength of 1000 volts
ESD immunity:	up to 15kV corresponding to IEC 801-2, Level 4
Termination:	Switchable termination network for RS485 operation
Power supply:	supplied power adapter or 12..24V DC/AC
Current consumption:	approx. 160mA @12V DC
RS422/RS485 adapter:	9-pin male SUB-D adapter
POF adapter:	Integrated socket with automatic interlocking of the fiber-optic cable
POF medium:	Duplex plastic optical fiber cable 2.2 x 4.4 mm, fiber diameter of 980µm, core: PMMA, cladding: PE
Ambient temperature:	storage: -40..+70°C operation: 0..+50°C at external 24V supply voltage
Housing / Dimensions:	small plastic housing for top hat rail mounting, 105x75x22mm
Weight:	approx. 600g incl. power adapter
Delivery:	RS422/RS485 <> POF Interface power adapter for application in office

20mA <> POF Interface, #41201

The W&T Interface Model 41201 permits bi-directional connection of 20mA devices with components, which are equipped with a plastic fiber optics interface.

Function

The Interface supports one data line in each direction and transmits data over a distance of max. 100 meters. The transmission medium is standard duplex plastic fiber optic cable, which is inexpensive and extremely easy to work with and install. The use of fiber optics as a transmission medium ensures perfect galvanic isolation between the connected devices and clean transmission even in noise-prone environments. The interface is build in a small plastic housing designed for top hat rail mounting according to DIN EN 50022-35.

Power supply

The interface uses a build-in switching regulator for power supply and has a wide input voltage range from 12V to 24V. The operating voltage can be supplied by the enclosed AC adaptor or by any other AC or DC voltage in the permissible range. The interface has a build-in reverse voltage protection. The power can be supplied by screwed contacts.

Isolation and ESD protection

The 20mA port of the device is isolated from the power supply with a dielectric strength of 1000 volts. The signals are isolated by means of high-speed opto-couplers; energy is supplied to the driver and receiver elements by means of an isolated DC/DC converter. All signal lines are protected against electrostatic discharge of up to 15kV according to IEC 801-2, level 4.

Connections

The fiber optic connection for the interface is configured as a self-locking coupling for duplex plastic fiber optics, with the 20mA interface formatted as DB9 male connector. Refer to the following table for connector pin assignments:

Pin#	Function
1	data out 20mA
2	data out +
3	data out -
4	data out GND
5	n.c.
6	data in 20mA
7	data in +
8	data in -
9	data in GND

Display elements

The interface includes two LEDs, with green for indicating the correct supply voltage and red for verifying data transmission in both directions.

Assembly

Connecting the plastic fiber optic cable to the interface requires no special tools:

- Trim the fiber optic cable to the desired length using a sharp knife. Make your cut as close to a right angle to the longitudinal axis of the cable as possible. A simple cut is generally sufficient, with no reworking required.
- Separate the individual duplex conductors back from the cut point to a distance of around 2cm.

- Pull the locking levers on the fiber optic female connector back towards the module along the upper side of the coupling.
- At the same time insert the separated end of the fiber optic duplex line into the fiber optic coupling female.
- Releasing the locking levers locks the fiber optics into the coupling.
- To release, pull the two locking levers on the top of the coupling towards the module, and pull the fiber optic cable out of the female.

The arrows on the top side of the coupling clearly show the location of the emitter and receiver lines.

Please note that when connecting two fiber optic components, the emitter of the first must always be connected to the receiver channel of the second component. A visible red light beam is always sent along with data, so that the sending line can always be easily identified.

Applications

The interface can be used as an active or passive 20mA component. In the active mode, the interface supplies the current required by the respective 20mA loop, while in the passive mode the loop current must be supplied by the connected device. The operating mode can be selected for both loops separately. Examples of interface switching into active/passive mode are shown in the following drawings:

Interface Tx and Rx loop active

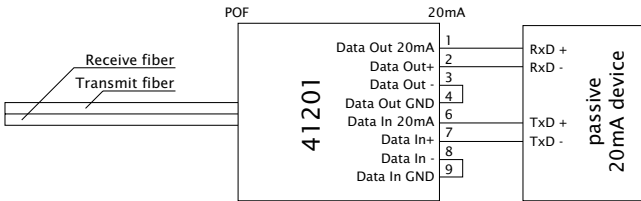

Interface Tx and Rx loop passive

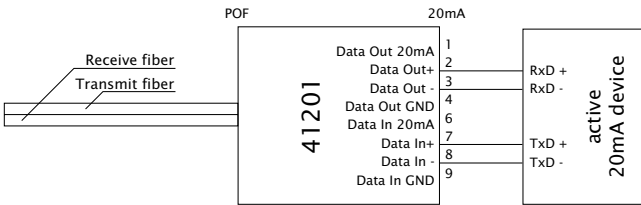

Interface Tx loop active, Rx loop passive

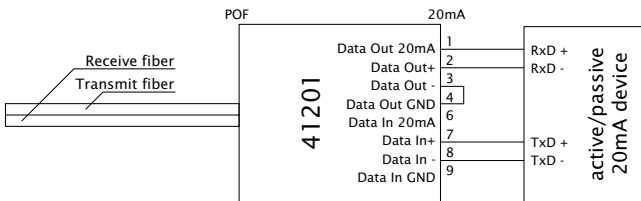

Technical Data

Baud rate:	0..19,200 baud
Data format:	any format
Supported signals:	RxD, TxD
Max. distance:	100m
Operating modes:	active or passive mode
Electrical Isolation:	Serial port from power supply with a dielectric strength of 1000 volts
ESD immunity:	up to 15kV corresponding to IEC 801-2, Level 4
Power supply:	supplied power adapter or 12..24V DC/AC
Current consumption:	approx. 120mA @12V DC
20mA adapter:	9-pin male SUB-D adapter
POF adapter:	Integrated socket with automatic interlocking of the fiber-optic cable
POF medium:	Duplex plastic optical fiber cable 2.2 x 4.4 mm, fiber diameter of 980µm, core: PMMA, cladding: PE
Ambient temperature:	storage: -40..+70°C operation: 0..+50°C at external 24V supply voltage
Housing / Dimensions:	small plastic housing for top hat rail mounting, 105x75x22mm
Weight:	approx. 600g incl. power adapter
Delivery:	20mA <> POF Interface power adapter for application in office

POF Repeater, #11201

The W&T Fiber Optic Repeater Model 11201 allows two components with plastic fiber optic interfaces to be connected over a distance of more than 100 meters.

Function

As a rule, the transmission distance between two devices with plastic fiber optic interfaces is limited by the high attenuation factor of the fiber optic cable to a maximum of 100 meters. The Repeater is inserted in the center of a long transmission line and amplifies the received light signals, restoring them to their original intensity. By dividing the transmission line into several 100-meter fiber optic segments, reliable data transmission even over very long distances can be achieved. The transmission medium is standard duplex plastic fiber optic cable, which is inexpensive and extremely easy to work with and install. The use of fiber optics as a transmission medium ensures perfect galvanic isolation between the connected devices and clean transmission even in noise-prone environments. The interface is build in a small plastic housing designed for top hat rail mounting according to DIN EN 50022-35.

Power supply

The repeater uses a build-in switching regulator for power supply and has a wide input voltage range from 12V to 24V. The operating voltage can be supplied by the enclosed AC adaptor or by any other AC or DC voltage in the permissible range. The interface has a build-in reverse voltage protection. The power can be supplied by screwed contacts.

Connections

The fiber optic connection for the repeater is configured as a self-locking coupling for duplex plastic fiber optics.

Display elements

The repeater includes two LEDs, with green for indicating the correct supply voltage and red for verifying data transmission in both directions.

Assembly

Connecting the plastic fiber optic cable to the repeater requires no special tools:

- Trim the fiber optic cable to the desired length using a sharp knife. Make your cut as close to a right angle to the longitudinal axis of the cable as possible. A simple cut is generally sufficient, with no reworking required.
- Separate the individual duplex conductors back from the cut point to a distance of around 2cm
- Pull the locking levers on the fiber optic female connector back towards the module along the upper side of the coupling.
- At the same time insert the separated end of the fiber optic duplex line into the fiber optic coupling female.
- Releasing the locking levers locks the fiber optics into the coupling.
- To release, pull the two locking levers on the top of the coupling towards the module, and pull the fiber optic cable out of the female.

The arrows on the top side of the coupling clearly show the location of the emitter and receiver lines.

Please note that when connecting two fiber optic components, the emitter of the first must always be connected to the receiver channel of the second component. A visible red light beam is always sent along with data, so that the sending line can always be easily identified.

Applications

RS232 data transmission via plastic fiber optic cable over a distance of more than 100 meters

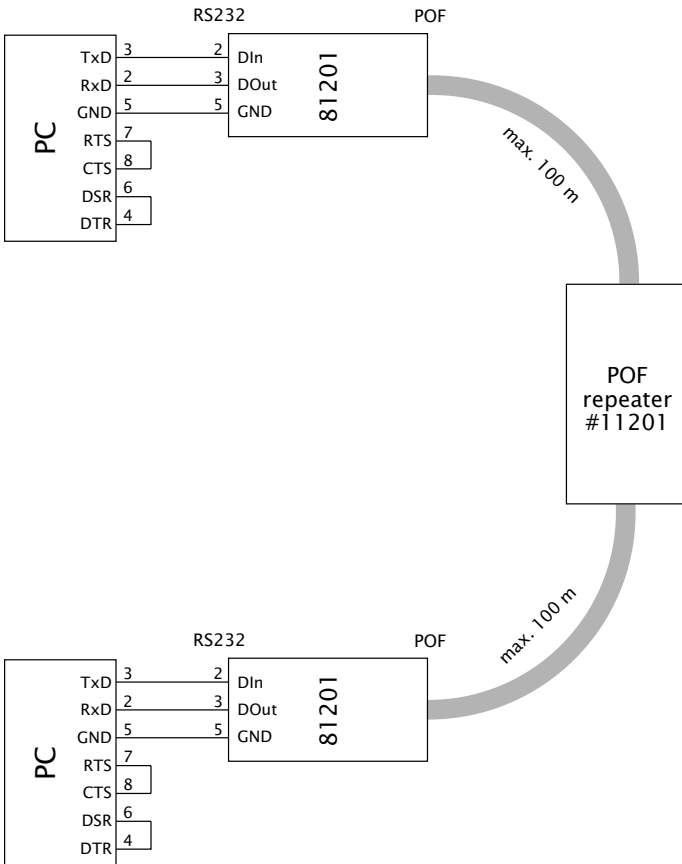

Technical Data

Baud rate:	0..115,200 baud
Data format:	any format
Supported signals:	RxD, TxD
Max. distance:	100m per POF segment
ESD immunity:	up to 15kV corresponding to IEC 801-2, Level 4
Power supply:	supplied power adapter or 12..24V DC/AC
Current consumption:	approx. 140mA @12V DC
POF adapter:	Integrated socket with automatic interlocking of the fiber-optic cable
POF medium:	Duplex plastic optical fiber cable 2.2 x 4.4 mm, fiber diameter of 980µm, core: PMMA, cladding: PE
Ambient temperature:	storage: -40..+70°C operation: 0..+50°C at external 24V supply voltage
Housing / Dimensions:	small plastic housing for top hat rail mounting, 105x75x22mm
Weight:	approx. 600g incl. power adapter
Delivery:	POF Repeater power adapter for application in office

RS232 Line Driver Set, #80201

The W&T Line Driver Set Model 80201 permits bi-directional connection of two RS232 devices over a distance of up to 1.200 meters.

Function

The line driver set consists of two identical interface modules RS232 <> RS422 and supports one data and one handshaking line in each direction.

To avoid the effects of ground potential difference, both ports of the line driver modules are isolated from each other and from the power supply with a dielectric strength of 1000 volts.

The line driver modules must be connected to the RS232 devices by additional shielded serial cables. The pinout of the RS232 cables is shown in the chapter "Applications" of this manual.

The RS232 Line Driver Set modules are build in a small plastic housing designed for top hat rail mounting according to DIN EN 50022-35.

Power supply

The interfaces of the line driver set use build-in switching regulators for power supply and has a wide input voltage range from 12V to 24V. The operating voltage can be supplied by the enclosed AC adaptor or by any other AC or DC voltage in the permissible range. The interfaces have a build-in reverse voltage protection. The power can be supplied by screwed contacts.

Isolation and ESD protection

Both ports of the device are isolated from each other and from the power supply with a dielectric strength of 1000 volts. The signals are isolated by means of high-speed opto-couplers; energy is supplied to the driver and receiver elements by means of an isolated DC/DC converter. All signal lines are protected against electrostatic discharge of up to 15kV according to IEC 801-2, level 4.

Connectors

The two ports of the W&T line driver module 80201 use DB9 male connectors. The connector pin assignments are shown in the table below:

RS232 interface:

Pin#	Function
2	data in
3	data out
4	handshake out
5	signal GND
8	handshake in

RS422 interface:

Pin#	Function
1	data out A (-)
2	data in A (-)
3	handshake out A (-)
4	handshake in A (-)
5	signal GND
6	data out B (+)
7	data in B (+)
8	handshake out B (+)
9	handshake in B (+)

Display elements

The interface includes two LEDs, with green for indicating the correct supply voltage and red for verifying data transmission in both directions.

Interconnecting cable

To ensure proper operation over long distances, 4-wire or 8-wire shielded twisted pair (STP) cable should be employed as interconnection cable. Because of the use of balanced RS422 interfaces, every transmitted RS232 signal requires one wire pair of the interconnecting cable. RS232 software handshake communications therefore require 2 pair STP cables, while communications with two additional hardware handshaking lines require 4 pair STP cables. One cable pair must be used for the inverting line (A) and the non-inverting line (B) of the same signal type. The cable shield shall be connected to the shell of the RS422 interface at both ends of the interconnecting cable.

Applications

Bidirectional RS232 application with hardware handshake

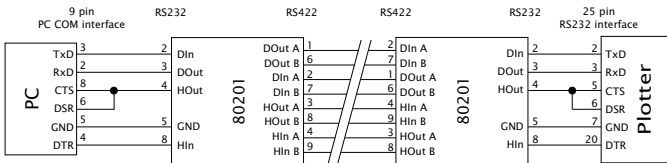

Bidirectional RS232 application with software handshake

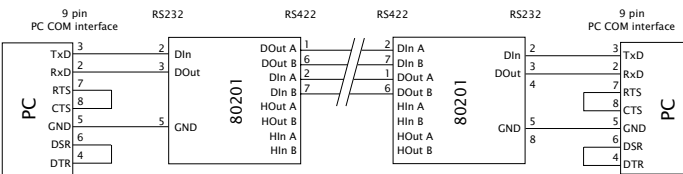

Technical Data

Baud rate:	0..115,200 baud
Data format:	any format
Supported signals:	RxD, TxD, CTS, DTR
Max. distance:	1000m
Electrical isolation:	both ports from each other and from power supply with a dielectric strength of 1000 volts
ESD immunity:	up to 15kV corresponding to IEC 801-2, Level 4
Power supply:	supplied power adapter or 12..24V DC/AC
Current consumption:	approx. 160mA @12V DC
RS232 adapter:	9-pin male SUB-D adapter
RS422 adapter:	9-pin male SUB-D adapter
Ambient temperature:	storage: -40..+70°C operation: 0..+60°C at external 24V supply voltage
Housing / Dimensions:	small plastic housing for top hat rail mounting, 105x75x22mm
Weight:	approx. 600g incl. power adapter
Delivery:	RS232 Line Driver Set power adapter for application in office