

Manual

Fiber Optic Interfaces



Type	81210, 81211 61210, 61211 65210, 41210
Release	1.2

© 09/2004 by Wiesemann & Theis GmbH

Subject to error and alteration:

Since it is possible that we make mistakes, you mustn't use any of our statements without verification. Please, inform us of any error or misunderstanding you come about, so we can identify and eliminate it as soon as possible.

Carry out your work on or with W&T products only to the extent that they are described here and after you have completely read and understood the manual or guide. We are not liable for unauthorized repairs or tampering. When in doubt, check first with us or with your dealer.

Glass fiber optic transmission lines are the solution of choice when you need to implement absolutely noise-free serial data transmission over long distances and/or in noisy environments.

Whereas the attenuation with plastic fiber optics places a limit of maximum 100 meters on the attainable cable length, the distances achievable with glass fiber optics are significantly greater and at a comparable cable cost.

Wiesemann & Theis offers an entire family of various fiber optic interfaces that allow you to convert the critical serial ports into an optical port for connecting glass fiber optic cable.

This interface family is described on the following pages along with the corresponding technical data and including connection examples.

For up-to-date information on new developments, see our Internet site at <http://www.wut.de> or check the e-mail short notices at the W&T Interface Club, which you can also subscribe to from the W&T Homepage.

Index

Common properties 33

Fiber Optic <> RS232 Interface without Handshake, #81210 .. 37

Fiber Optic <> RS232 Interface with Handshake, #81211 39

Fiber Optic <> RS485 / RS422 Interface, #61210 41

Fiber Optic <> Profibus Interface, #61211 45

Fiber Optic <> 20mA Interface, #41210 47

Fiber Optic Bus <> RS485 Interface, #65210 51

Declaration of Conformity 55

Common properties

Function

All W&T Fiber Optic Interfaces convert the data lines of serial ports (RS232, RS485, RS422, Profibus, 20mA) into a port for glass fiber optic cable. In addition, Interface #81211 provides a conversion for RS232 that supports not only the data lines but also two hardware handshake lines.

Well-known ST connectors are used for connecting the glass fiber optic cable, whereas the serial interface is configured as a 9-pin SUB-D connector.

The light used for data transmission has a wavelength of 820 nm. Commonly available Multimode duplex glass fiber optic cable in 50/125 μm or 62.5/125 μm is used as the transmission medium, which due to its wide application in networking is easily available and cost-effective. This means that even already existing glass fiber optic lines intended for use in networks can easily be used for transmitting serial data. Depending on the attenuation of the glass fiber optic cable used, data can be transmitted over a distance of maximum 3800 meters.

Supply voltage

The supply voltage for the Interfaces is provided through an integrated switching regulator. This regulator has a variable input voltage range and allows the Interface to be powered by the supplied plug-in power supply or by any AC or DC voltage between 12 and 24 volts.

The supply voltage is polarity reversal protected and can be connected on the underside of the Interface either through the built-in jack socket or the included plug-in screw terminal.

Galvanic isolation and ESD protection

The serial ports for all Interfaces are galvanically isolated from the supply voltage through a DC/DC converter with an isolation voltage of 1 kV.

All signal lines for the serial interface are protected by ESD-immune interface chips against static discharge for voltages up to 15 kV corresponding to IEC 801-2, Level 4.

Housing

The W&T Fiber Optic Interfaces are contained in a plastic housing for mounting on standard rails according to DIN EN 50022-35.

To configure the RS485 / RS422 Interfaces, the enclosure must be opened to set the mode type/termination DIL switches on the interface module.

For this purpose we recommend threading a SUB-D connector with connector body onto the Interface and use the threaded-on connector to assist in removing the housing cover from the housing body.



Common technical data

Data format:	any data format
Isolation:	min. 1 kV between serial interface and power supply
Power supply:	Supplied power adapter or 12..24 V DC/AC
Current consumption:	max. 150 mA at 12 V input voltage
Serial connector:	9-pin SUB-D adapter
FO cable connector:	ST plug adapter SMA plug adapter on request
Fiber-optic medium:	Duplex multimode fiber-optic cable
Max. distance:	50/125 μ m: typ. 3200m, min. 1400m @3dB/km 62.5/125 μ m: typ. 3800m, min. 2200m @3.5dB/km 200 μ m PCS fiber: typ. 2500m, min. 1500m @8dB/km
Optical budget:	50/125 μ m: typically 9.6dB, min. 4.2dB 62.5/125 μ m: typically 13.4dB, min. 8.0dB 200 μ m PCS fiber: typically 20dB, min. 12dB
Ambient temperature:	Storage: -40..+70°C Operation: 0..+60°C at external 24V supply voltage
Housing:	Small plastic housing for top hat rail mounting
Weight:	approx. 500 g incl. power adapter

Interface FO <> RS232 without handshake, #81210

Function

The W&T Interface 81210 allows bi-directional conversion of an RS232 interface into a fiber optic interface with a transmission speed of up to 230.000 bps. The interface works independently of the data format used and converts one data line in each direction.

Connectors

The fiber optic cables are connected to the converter using ST series connectors, with a DB9 plug for the RS232 connection. The arrangement of the signal connectors on the front panel of the interface can be seen from the following illustration:

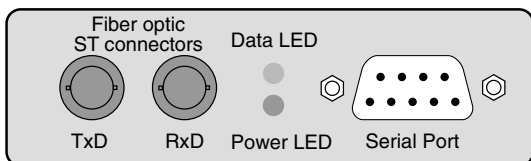

The pin configuration for the serial connector is shown in the following table, and may also be found on a sticker attached to the device:

Pin#	Function
2	data in
3	data out
4	active level
5	signal GND
7	active level

Applications

**RS232 <> Fiber optic interface
application with software handshake**

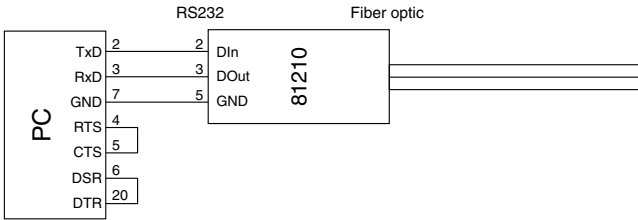

Technical data

Baud rate: 0..230 kbps
 Transmitted signals: RxD, TxD

Serial connector: 9-pin SUB-D plug
 with DTE pinout

Dimensions: 105x75x22mm

Packing list: 1x RS232 Fiber Optic Interface
 1x power adapter for
 application in office

Interface FO <-> RS232 with handshake, #81211

Function

The W&T Interface 81211 allows bi-directional conversion of an RS232 interface into a fiber optic interface with a transmission speed of up to 115.200 bps. The interface works independently of the data format used and converts one data line and one hardware handshake line in each direction.

Connectors

The fiber optic cables are connected to the converter using ST series connectors, with a DB9 plug for the RS232 connection. The arrangement of the signal connectors on the front panel of the interface can be seen from the following illustration:

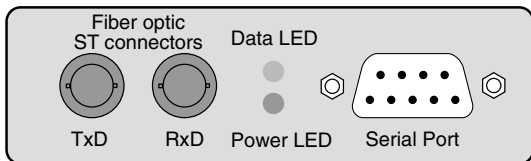

The pin configuration for the serial connector is shown in the following table, and may also be found on a sticker attached to the device:

Pin#	Function
2	data in
3	data out
4	active level
5	signal GND
7	handshake out
8	handshake in

Applications

RS232 <> Fiber optic interface application with hardware handshake

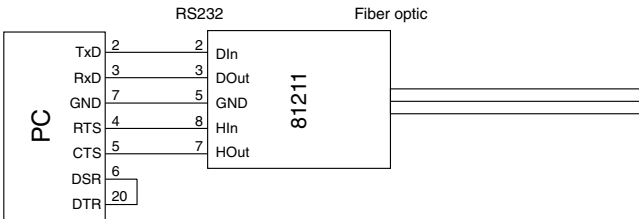

Technical data

Baud rate: 0..115 Kbps
 Transmitted signals: RxD, TxD, RTS, CTS

Serial connector: 9-pin SUB-D plug
 with DTE pinout

Dimensions: 105x75x22mm

Packing list: 1x RS232 Fiber Optic Interface
 1x power adapter for application in office

Interface FO <> RS485 / RS422, #61210

Function

The W&T Interface 61210 allows bi-directional conversion of an RS485 or an RS422 interface into a fiber optic interface with a transmission speed of up to 1,5 Mbps. The interface works independently of the data format used and converts one data line and one hardware handshake line in each direction.

Connectors

The fiber optic cables are connected to the converter using ST series connectors, with a DB9 plug for the RS485 / RS422 connection. The arrangement of the signal connectors on the front panel of the interface can be seen from the following illustration:

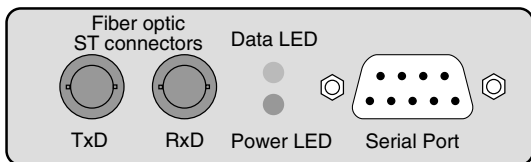

The pin configuration for the serial connector is shown in the following table, and may also be found on a sticker attached to the device:

Pin#	Function
1	data out A (-)
2	data in A (-)
5	signal GND
6	data out B (+)
7	data in B (+)

Operating mode

The W&T interface 61210 can be set for three different operating modes by DIP switch setting on the RS422/RS485 interface module. The selectable operating modes are briefly described here:

RS422, RS485 4-wire bus master application

One data channel and one handshake channel in each direction are available. The RS422/RS485 receivers and transmitters are always active in this operating mode.

RS485 4 wire / RS485 2-wire application with echo

One data channel in each direction is available. The RS485 output driver is activated automatically with each transmission of data, and goes to the high impedance state again after the end of transmission. The RS485 receiving channel is always active in this operating mode.

RS485 2 wire application without echo

One data channel in each direction is available. The RS485 output driver is activated automatically with each transmission of data, and goes to the high impedance state again after the end of transmission. The RS485 receiving channel is deactivated when the driver is on, but is switched on when the driver is in the high impedance state.

Please see the following table for an explanation of the operating mode DIP switch:

Operating mode	SW1	SW2	SW3	SW4	SW5
RS422, RS485, 4-wire bus master	OFF	OFF	OFF	ON	OFF
RS485, 4-wire / 2-wire with echo	OFF	ON	OFF	ON	OFF
RS485, 2-wire bus systems w/o echo	ON	ON	OFF	ON	OFF

Termination

For all RS485 operating modes it is essential that the bus system be terminated with a termination network which assures a defined rest state in the high-impedance phases of bus operation.

The bus system can be connected to a termination network by closing switches #6 and #7 on the interface module:

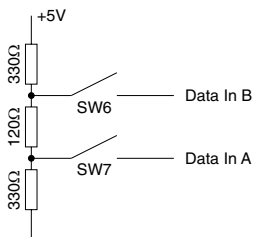

Applications

RS422 application

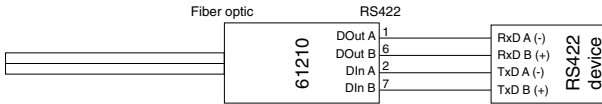

RS485 4-wire bus master application

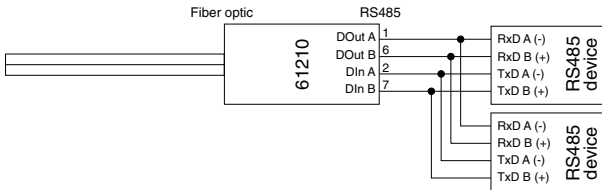

RS485 2-wire application

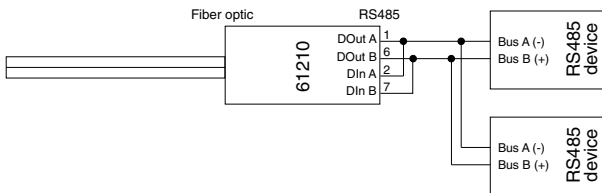

Technical data

Baud rate: 0..1,5 Mbps

Transmitted signals: RxD, TxD

Serial connector: 9-pin SUB-D plug

Dimensions: 105x75x22mm

Packing list: 1x RS485/RS422 Fiber Optic Interface
1x power adapter for application in office

Interface FO <-> Profibus, #61211

Function

The W&T Interface 61211 allows bi-directional conversion of an Profibus interface into a fiber optic interface with a transmission speed of up to 1,5 Mbps. The interface works independently of the data format used and converts one data line in each direction.

Connectors

The fiber optic cables are connected to the converter using ST series connectors, with a DB9 socket for the Profibus connection. The arrangement of the signal connectors on the front panel of the interface can be seen from the following illustration:

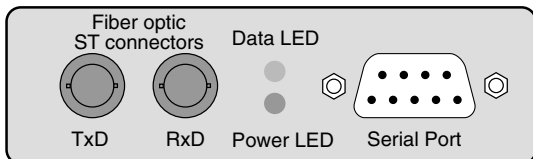

The pin configuration for the serial connector is shown in the following table, and may also be found on a sticker attached to the device:

Pin#	Function
1	Shield
2	n.c.
3	RxD/TxD-P
4	CNTR-P
5	DGND
6	VP
7	n.c.
8	RxD/TxD-N
9	CNTR-N

Termination

Both ends of a Profibus segment must be terminated with a terminating network which is usually integrated into the Profibus connectors and can be optionally switched. This resistor network has two functions: to ensure reflection-free termination of the line, and to provide a defined rest state on the lines during the high-impedance phases of the bus system.

To supply the termination network, Pin 6 provides 5 V referenced to the ground Pin 5, with a maximum load capacity of 50 mA.

Technical data

Baud rate:	0..1,5 Mbps
Transmitted signals:	RxD, TxD
Serial connector:	9-pin SUB-D socket
Dimensions:	105x75x22mm
Packing list:	1x Profibus Fiber Optic Interface 1x power adapter for application in office

Interface FO <> 20mA #41210

Function

The W&T Interface 41210 allows bi-directional conversion of an 20mA interface into a fiber optic interface with a transmission speed of up to 19.200 bps. The interface works independently of the data format used and converts one data line in each direction.

Connectors

The fiber optic cables are connected to the converter using ST series connectors, with a DB9 plug for the 20mA connection. The arrangement of the signal connectors on the front panel of the interface can be seen from the following illustration:

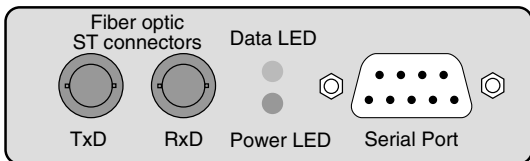

The pin configuration for the serial connector is shown in the following table, and may also be found on a sticker attached to the device:

Pin#	Function
1	data out 20mA
2	data out +
3	data out -
4	data out GND
5	n.c.
6	data in 20mA
7	data in +
8	data in -
9	data in GND

Applications

The interface can be used as an active or passive 20mA component. In the active mode, the interface supplies the current required by the respective 20mA loop, while in the passive mode the loop current must be supplied by the connected device. The operating mode can be selected for both loops separately. Examples of interface switching into active/passive mode are shown in the following drawings:

Interface Tx and Rx loop active

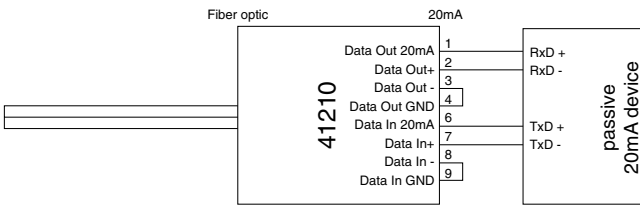

Interface Tx and Rx loop passive

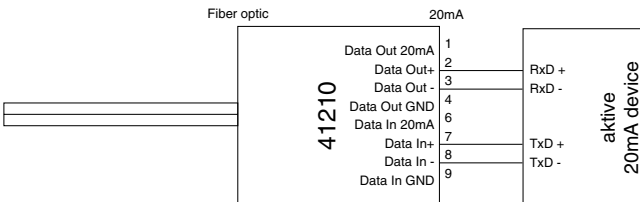

Interface Tx loop active, Rx loop passive

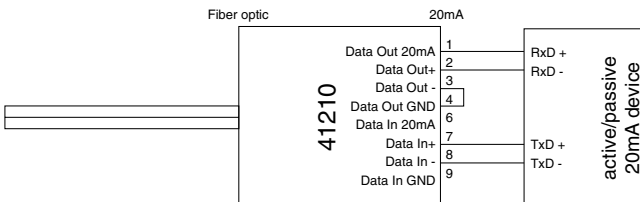

Technical data

Baud rate:	0..19.200 bps
Transmitted signals:	RxD, TxD
Operating mode:	active mode passive mode
Serial connector:	9-pin SUB-D plug
Dimensions:	105x75x22mm
Packing list:	1 x 20mA Fiber Optic Interface 1 x power adapter for application in office

Interface FO Bus <> RS485, #65210

Function

The W&T Interface #65210 allows bi-directional conversion of an RS485 interface into a fiber optic bus interface with a transmission speed of up to 1,5 Mbps. The interface works independently of the data format used and converts one data line in each direction.

The interface can also be used as a repeater for fiber optic cable if the RS485 port is not connected.

Connectors

The fiber optic cables are connected to the converter using ST series connectors, with a DB9 plug for the RS485 connection. The arrangement of the signal connectors on the front panel of the interface can be seen from the following illustration:

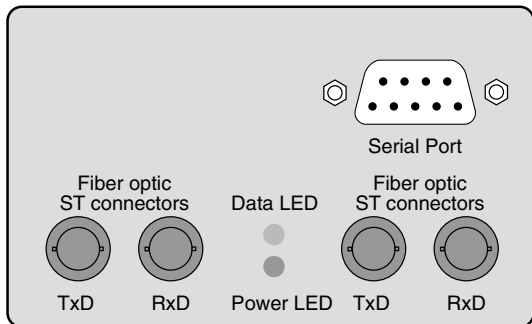

The pin configuration for the serial connector is shown in the following table, and may also be found on a sticker attached to the device:

Pin#	Function
1	data out A (-)
2	data in A (-)
5	signal GND
6	data out B (+)
7	data in B (+)

Termination

For all RS485 operating modes it is essential that the bus system be terminated with a termination network which assures a defined rest state in the high-impedance phases of bus operation.

The bus system can be connected to a termination network by closing switches #6 and #7 on the interface module:

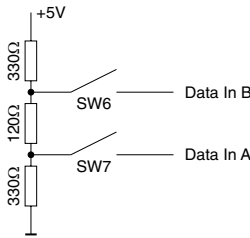

Operating mode

The interface #65210 can be set for two different operating modes by DIP switch setting on the RS485 interface module. The selectable operating modes are briefly described here:

RS485 4 wire application, automatic control

One data channel in each direction is available. The RS485 output driver is activated automatically with each transmission of data, and goes to the high impedance state again after the end of transmission. The RS485 receiving channel is always active in this operating mode.

RS485 2 wire application, automatic control

One data channel in each direction is available. The RS485 output driver is activated automatically with each transmission of data, and goes to the high impedance state again after the end of transmission. The RS485 receiving channel is deactivated when the driver is on, but is switched on when the driver is in the high impedance state.

Please see the following table for an explanation of the operating mode DIP switch:

Operating mode	SW1	SW2	SW3	SW4	SW5
RS485, 4-wire bus systems	OFF	ON	OFF	ON	OFF
RS485, 2-wire bus systems	ON	ON	OFF	ON	OFF

Applications

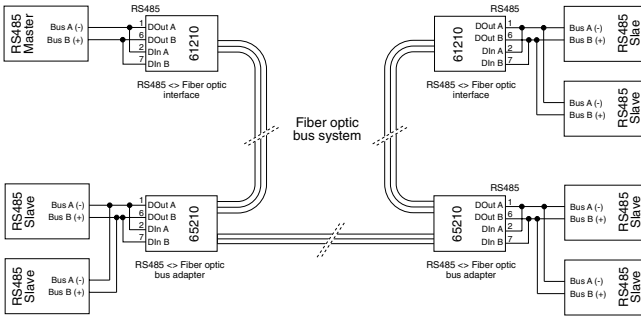

Technical data

- Baud rate: 0..1,5 Mbps
- Transmitted signals: RxD A/B, TxD A/B
- Cascadability: 5 Adapter @115Kbps
32 Adapter @19,2Kbps
- Serial connector: 9-pin SUB-D plug
- Dimensions: 105x75x22mm
- Packing list: 1x RS485 Fiber Optic Bus Interface
1x power adapter for application in office

EC Declaration of Conformity

www.WuT.de

W&T interfaces for TCP/IP, Ethernet, RS-232, RS-485, USB, 20mA Glass and Kunststoff/LML, Mod. SNMP, OPC, IO digital, IO analog, RS-485, PCI...

**Declaration of conformity
according to paragraph 10.1 of directive 89/336/EWG**

Wiesemann & Theis GmbH hereby confirms that the products

RS232 ↔ Plastic FO Interface, 9-pin.	Model 81009
RS232 ↔ Plastic FO Interface, 9-pin, Low Power	Model 81009-20
RS232 ↔ Plastic FO Interface, 25-pin, DCE	Model 81025
RS232 ↔ Plastic FO Interface, 25-pin, DTE	Model 81026
20mA ↔ Plastic FO Interface, 15-pin.	Model 41015
RS232 ↔ Glass FO Interface	Model 81210
RS232 ↔ Glass FO Interface with Handshake	Model 81211
RS422/485 ↔ Glass FO Interface	Model 61210
Profibus ↔ Glass FO Interface	Model 61211
20mA ↔ Glass FO Interface	Model 41210
RS485 ↔ Glass FO Bus Interface	Model 65210

fulfill the requirements of the directives / regulations specified below:

1. Emission according to
 - 1.1. EN 55022 Cl. B (1998) +A1 +A2
 - 1.2. EN 61000-3-2 (2000)
 - 1.3. EN 61000-3-3 (1995) + A1
2. Noise Immunity according to EN 61000-6-2 (2001):
 - 2.1. EN 61000-4-2 ESD
 - 2.2. EN 61000-4-3 Radiated Immunity
 - 2.3. EN 61000-4-4 Burst
 - 2.4. EN 61000-4-5 Surge
 - 2.5. EN 61000-4-6 Conducted Immunity
 - 2.6. EN 61000-4-8 H-Field
 - 2.7. EN 61000-4-11 Supply Voltage Dips and Interruptions
3. Product-specific Low-Voltage Directive for communications technology
 - 3.1. EN 60950 (2003)

Wuppertal, 03/10/2006

Klaus Meyer, EMC Representative

Dipl.-Ing. Rüdiger Theis, Managing Director

Wiesemann & Theis GmbH
Porschestraße 12
42279 Wuppertal
Cf. Dipl.-Ing. Rüdiger Theis

Tel.: 0202/2680-0
Fax: 0202/2680-265
info@wuT.de
www.WuT.de

Handelsregister:
Amtsgericht Wuppertal HRB6377
UID-Nr.: DE 231008340
Steuer-Nr.: 131/5937/014

Bankverbindung:
Postbank Essen
Konto: 388397436
BLZ: 36010043

W&T